

Historic, archived document

Do not assume content reflects current scientific knowledge, policies, or practices

56Cm

LIBRARY RECEIVED
★ JUN 9 1925 ★
U. S. Department of Agriculture

**UNITED STATES
DEPARTMENT OF AGRICULTURE**

MISCELLANEOUS CIRCULAR 15

Washington, D. C.

Issued March, 1924
Revised May, 1925

**IMPORTANCE OF FORESTRY AND THE NATIONAL
FORESTS**

Information for Social and Civic Organizations in the Southwest

United States Forest Service, District 3, Albuquerque, N. Mex.

FOREWORD

PROMINENT among the problems that are engaging the Nation is that of an impending timber shortage. America was originally endowed with natural resources that seemed inexhaustible. In that belief the United States became a nation of thoughtless users and even wasters of the things that are necessary to the development and carrying on of present-day civilization.

This has been especially true in the matter of timber. The depletion of timber has gone so far that what in many localities was once an incumbrance to the land is now a valued commodity that must be brought from afar. Enormous freight bills and ever-mounting selling prices testify that lumber is no longer plentiful in America. Constantly shrinking forest areas proclaim that the time is near when regions capable of producing timber must grow their own or do without. Europe can hardly sustain itself and certain Provinces in Canada are already prohibiting exportations of pulp wood from Crown lands. Aroused to this condition economists are urging a national policy of forestry practice.

Some progress in constructive timber production has already been made, and though not soon enough to prevent timber scarcity will help to render it less hurtful. Several of the States, a few counties, and a number of cities have acquired timberlands and are administering them under approved timber growing practices. Under provision of the enabling act in Arizona and special cooperative agreements in both States, the State-owned forest areas in Arizona and New Mexico are handled in the same manner as the national forests. Sales of timber are in fact administered by Forest Service men loaned to the State for such lengths of time as they are needed.

SUGGESTION

This circular is the outgrowth of a demand by members of clubs and societies that are pursuing self-culture and current thought, and has been prepared for people who do not have time for exhaustive study of subjects that are not main objectives in life. No attempt at argument has been made. It is a collection of concise facts in sharp brevity. Those who find it possible to delve deeper, however, will find profitable and interesting reading in any or all of the following Government bulletins. They may be obtained for a nominal sum from the Superintendent of Documents, Government Printing Office, Washington, D. C., or without charge, while the supply lasts, from the District Forester, United States Forest Service, Albuquerque, N. Mex.

Forests and Forestry in the United States. (Forest Miscellaneous Circular.)

How the Public Forests are Handled. (Year Book Separate 847.)

Wood for the Nation. (Year Book Separate 835.)

Timber Depletion and the Answer. (Department Circular 112.)

Government Forest Work. (Department Circular 211.)

The Sunshine Recreation Ground of a Nation. (Forest and road map of Southwest with general information.)

The National Forests of Arizona. (Map and folder distributed by Forest Service.)

The National Forests of New Mexico. (Department Circular 240.)

In the Land of the Ancient Cliff Dweller; the Bandelier National Monument. (Miscellaneous Circular 5.)

Timber: Mine or Crop? (Yearbook Separate 886.)

WHO PAYS THE FREIGHT?

The Nation's lumber shipment in 1920 was about 2,070,000 carloads, and the average haul for each carload 485 miles. According to the best estimate of the Forest Service, the freight bill on lumber for that year was \$275,000,000. A fraction of this sum wisely invested each year in forest protection and rehabilitation would grow timber where it is needed, reduce the Nation's freight bill, cheapen lumber, and release vast amounts of railroad equipment and labor for unavoidable transport. Coal and iron can not be grown, but timber can be.

STUDY NO. 1

AMERICAN FORESTS AND THE LUMBER INDUSTRY

What the early colonist found.—When the colonist reached the shores of America he found a vast forest, almost unbroken, from Maine to Florida and westward for an unknown distance. It was composed of hardwoods—oaks, elms, beeches, maples, chestnuts, and hickories; and softwoods or conifers—pines, spruces, and hemlocks. It has been estimated that this great forest covered 822,000,000 acres, an area 10 times as large as New Mexico and 11 times as large as Arizona, and that it contained 5,200,000,000 board feet of timber.

How the colonist regarded the forests and what he did with them.—The colonist was dependent upon the soil for his living. Very little open land invited his plow. He naturally assumed that the

forest was his enemy and he fought it with every means at his command. The forest provided material for his house and warmed it, it is true, but once his improvements were made and his fuel supplied he had no use for what was left. The forests kept crowding back upon his farm land. They harbored the savage and the beast that preyed upon his progress. With ax and fire he finally won the battle, but he helped to cripple one of the best resources of his country.

First sawmills.—With the settling of the country it was not convenient for each man to go into the forest and cut the logs for his house. There was a demand for lumber and sawmills were started. They were small and crude affairs and turned out but little lumber, enough, however, for the needs of the times. These first mills were close to the settlements. All along the Atlantic coast each community had its mills. Logs were brought from the near-by woods,

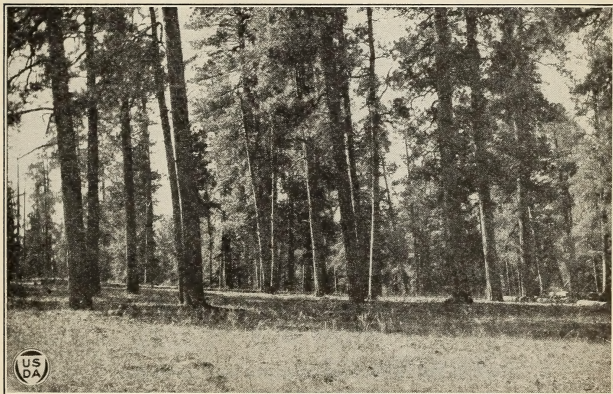

Western yellow pine—the most important timber tree of the Southwest

sawed into lumber, and the product hauled direct to the building sites.

Development and expansion.—As the population increased and spread out, greater and greater demands for lumber arose. Larger mills were built and lumbering became a trade. Ships that brought commodities from Europe carried lumber back. Shipyards in which wooden merchant vessels were constructed were established close to growing material. Railroads were thrust westward and lumber sent to prairie homesteads.

Mills compelled to move.—The history of the American lumber industry is a story of the depletion of forests and the migration of sawmills. This began on the coast of New England; then New York, Pennsylvania, the Great Lakes region, and the Southern States were included. The scene is at present shifting from the Southern States to the Pacific coast, and in this move we are nearing the closing

chapter. In the wake of this migration lie dreary cut-over wastes and fire-blackened hills, dismantled mills and deserted towns. On the western slope are the last big areas of virgin forest in the United States.

NOT OURS FOR WASTING

God has lent us the earth for our life. It is a great entail. It belongs as much to those who are to come after us as to us, and we have no right, by anything we do or neglect, to involve them in any unnecessary penalties or to deprive them of the benefit which it was in our power to bequeath.

—Ruskin.



Destructive logging and fire make waste land

STUDY NO. 2

WHERE THE AMERICAN FORESTS ARE SITUATED

Atlantic coast forests.—New England has passed through every stage of forest exploitation, from the days when nothing but the best white pines and oaks were considered merchantable to the present dependence upon other sections for lumber and pulp wood. The experience of New York and Pennsylvania has been similar to that of New England. From an original area of 110,000,000 acres, New England, New York, and Pennsylvania forests have shrunk to 40,000,000 acres, and much of this is second growth.

Lake States forests.—Michigan, Wisconsin, and Minnesota, commonly called the Lake States, once had one-eighth of the entire forested area of the United States. It covered 112,000,000 acres and from 1870 to 1900 yielded an annual cut of 8,000,000,000 feet. The area has been reduced to 24,000,000 acres and the output to 1,000,000,000 feet. Over 20,000,000 acres in the Lake States, suitable only for the growing of timber, are now fire-swept regions or devastated sad plains and swamps.

Southern pine forests.—The famous pineries of the South are still a most important factor in the lumber production of the Na-

tion. They furnish a third of the cut of the entire country and will remain important for at least another 10 or 15 years. Very little was done with the wonderful southern forests until after the Civil War, but depletion has been so rapid since that the end is already plainly in view.

Pacific coast forests.—Practically half of the remaining virgin timber in the United States is in the Pacific coast forests. Washington leads all States in the production of lumber, having recently wrested this honor from Louisiana. The trees of commercial importance on the Pacific coast are Douglas fir, western yellow pine, western hemlock, redwood, sugar pine, true fir, western red cedar, and lodgepole pine. Very little lumber was cut in California or the Northwest before the gold rush in 1849, but the inroad upon the last great reserve of coniferous timber has progressed far.

Rocky Mountain forests.—The Rocky Mountain forests are those in Montana, Idaho, Wyoming, Utah, Colorado, western South Dakota, Nevada, Arizona, and New Mexico. Sixty-four million acres were embraced in the original forested areas of these States, and there are still about 61,000,000 acres. The timber grows very slowly, however, and from 150 to 200 years are required for the principal lumber trees to mature. Montana and Idaho are the only States in this group producing lumber above their actual needs. Arizona has 5,000,000 acres in forest, and in 1923 cut 130,000,000 feet of lumber; the same year New Mexico, with forests covering 5,250,000 acres, cut 136,000,000 feet.

FOREST ODORS

Surely of all smells in the world the smell of many trees is the sweetest and most fortifying. The smell of a forest is infinitely changeful; it varies with the hour of the day not in strength merely, but in character; and the different sorts of trees as you go from one zone of the wood to another seem to live among different kinds of atmosphere.

—Robert Louis Stevenson.

STUDY NO. 3

FORESTRY AND WHAT IT IS

It has been demonstrated throughout the world that it is possible to harvest the mature or ripe timber from land and to grow another forest on the same area. Timber growing is an agricultural pursuit. It is very like the production of crops of alfalfa, corn, and wheat from farm land. Timber crop succession on the timberlands of the Southwest depends essentially upon the ability to secure the setting of the second crop by natural revegetation. The costs of reforestation by artificial means—that is, by planting—make that method impracticable for this region. Natural reproduction can be accomplished, however, through proper planning and handling of the forest before and during the harvest of the ripe timber. Making land that is best suited to tree growing yield successive crops of timber, including all the steps necessary to the process, is forestry.

Forest benefits.—Wood and its products enter in some form or other into practically every activity of life. They are absolutely

essential to our scheme of civilization. Forests, however, yield other benefits as well, intangible values that can not be reckoned on a balance sheet. They form, fix, and improve the soil. They bind the earth on steep slopes and prevent erosion. Old leaves cover the ground, and through decay make a humus that acts like a sponge. Water from rain and melting snow, instead of rushing away in roaring floods, is held back and fed out to springs and streams in a constant supply. By stabilizing the streamflow, the tearing away or burying under worthless mud of fertile valley fields and the filling of irrigation reservoir and ditches with silt are avoided. Forests provide homes for harmless wild life and furnish to humanity delightful retreats from the scorching heat of summer. They are the Nation's playgrounds.

Tree distribution.—Approximately 500 species of trees are native to the United States and a great many others have become established through introduction from other countries. Climate, mois-



Harvesting the crop

ture, soil, and certain other influences determine the distribution of trees. Hardwood trees demand rich soil, while as a general rule the softwoods—coniferous trees—though they exceed the hardwoods in commercial importance, are found on poorer soils. These conifers, the pines, the firs, and the spruces, with the help of junipers and pinions, make up the Rocky Mountain forests. They are the native trees of the Southwest. Practically no saw-timber forests are found in Arizona and New Mexico below an altitude of 6,000 feet. First above the treeless plains and valleys come the junipers and pinions, then the pines, and finally the firs and spruces.

How trees grow.—Trees grow in height by the formation of new wood cells on the top of the previous year's growth and in diameter by putting on a new layer of wood each year under the bark. The rate of growth depends upon soil, moisture, light, and heat. Different kinds of trees grow at different rates. Trees in a dense forest grow in height more rapidly than trees in the open on account of a constant struggle to reach the light. The age of a tree that has been

cut, can be told by counting the concentric rings of growth on the stump, or by boring into the living tree with an instrument that removes a small cylindrical section on which the annual growth rings show. No average rate of growth can be given for the great variety of trees in the United States, but in the Southwest it takes common lumber species 150 to 200 years to reach a diameter of 20 to 23 inches.

TIMBER HARVESTS

Timber is a crop—one of our most important crops. It grows, ripens, and becomes ready for the harvest just as other agricultural crops. It should be harvested in season and another crop grown for the use of future generations. It must be protected from fires, from plant diseases, from insect pests, just as other agricultural crops are protected.

—Henry C. Wallace.

STUDY NO. 4

NATIONAL FORESTS

Location and extent of the national forests.—There are in the continental United States nearly 150 national forests including two in Alaska. In addition to these there is one in Porto Rico, and the total net area is more than 157,000,000 acres. The largest national forest area in the United States proper is in California. The forests are located in 27 States, most of them being in the West. The first ones were created in 1897 from the unreserved public domain and at that time all were west of the Mississippi River. Now, however, through purchase under the Weeks law, national forests are being established on the headwaters of important streams in the eastern mountains from Georgia to Maine.

Property of all the people.—The national forests are the property of all the citizens of the United States. While the people in the immediate vicinity no doubt receive the greatest amount of direct benefit from the national forests, they are but cosharers in ownership. Every person who enters a national forest has broad rights and privileges, but the exercise of these must be consistent with the rights and privileges of every other citizen. Forests are for use, but not for abuse. The Federal Government, through the Forest Service, is protecting and managing the national forests for the good of the whole people.

What the public forests are for.—As provided in the basic law of 1897, national forests have for their objects the improvement and protection of the forests within their boundaries, the securing of favorable conditions of waterflow, and the furnishing of a continuous supply of timber for the use of the citizens of the United States. This calls for the utilization of all the resources which the forests contain in ways which will make them of the greatest service, and this means the greatest good to the greatest number in the long run. It means conservation through use and the national forests will be so managed as to grow successive crops of timber on land best suited to timber production; they will exert their influence to prevent erosion and to control streamflow, to harbor game, and to furnish ideal recreation to all people who can reach them.

National forests of the Southwest.—There are 14 national forests in the Southwest, 8 in Arizona and 6 in New Mexico. These forests contain 191½ million acres of land, ranging in elevation from 5,000 to 12,000 feet. They include the Rock Mountains of New Mexico, the Colorado Plateau of Arizona, scattered mountain ranges that rise from the deserts of the southern parts of these States, and the rough cactus and brush-covered watershed about the Roosevelt Reservoir. There are growing in them 23 billion feet of saw timber and 23 million cords of wood. Without these forests the Southwest would be scarcely habitable. Every acre of irrigated land is dependent upon the water that is conserved in the timbered mountains. Without them there would be no Roosevelt Lake or Elephant Butte Reservoirs; no verdant Salt River project with beautiful palms and orange groves; no Mesilla Valley with waving grain and fields of



The rangers keep watch over the forests

cotton. Without the forests there would be no cities like Phoenix or Albuquerque, as we know them, because there would be no adequate water supply for domestic use in cities. The forests of the Southwest are grazed annually by 520,000 cattle, 730,000 sheep and goats, 7,000 horses, and 800 swine; 500,000 recreationists visit them every year, and many permanent summer homes, municipal camps and playgrounds, and public picnic areas have been established.

STUDY NO. 5

MANAGEMENT OF FOREST LANDS

Highest use.—The national forests, as well as most other timberlands, occupy areas that are generally mountainous. Much of the land within the forests is rugged. It will grow trees, but is unsuitable for almost any other purpose. Such places meet their highest use in the production of timber. The production of timber on the headwaters of streams is consistent with the protection of watersheds from which cities and irrigation projects obtain their water

supplies; it is consistent with the grazing of reasonable numbers of livestock and the harboring of wild game, and it in nowise prohibits camping and other recreational uses of the forest. It is, in fact, the only practice that ensures all of these things to the people. The Federal law requires that the national forests be managed so that when timber is removed as it becomes ripe for cutting the areas will be left in shape to produce new crops of timber.

Forest products.—It is not unusual to think of forest products as lumber, timber, pulp wood for print paper, and fuel, and to

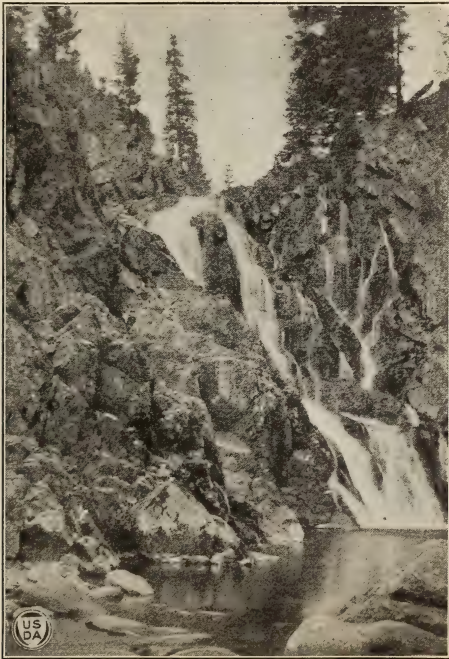

Forested mountains mean irrigated valleys

forget the numberless things into the composition of which wood enters. Turpentine and rosin come from pines. Methyl or wood alcohol is being distilled from hardwoods and ethyl or "grain" alcohol from softwoods. Phonograph records are 60 to 80 per cent wood flour. Linoleum is made from wood flour and linseed oil. Artificial silk is manufactured from wood cellulose, and certain styles of furniture from paper reeds. Twine, viscose sausage casings, woven bags, baskets, and many other things are being made of paper, the fibers of which grew in the woods. The United States

is producing half of the lumber cut of the world and using 95 per cent of it at home. The consumption and destruction of wood in the United States amounts to about 56,000,000,000 board feet annually. The present population of Arizona and New Mexico is using 300,000,000 feet a year, not including cordwood or mine props. As the Southwest develops and the population increases, demand for timber here as elsewhere will increase correspondingly.

Need for management.—The United States contains 469,000,000 acres of forest land of all sorts, timbered, cut-over, and burned. Most of this should always be forest land. It is an area which, if it can be kept at work growing trees, is ample to furnish all of the wood needed for home use and for export trade. Eighty million acres of these forest lands, however, have been denuded to the point of absolute idleness so far as the production of timber of commercial value is concerned and millions of other acres of cut-over land are reproducing at but a fraction of their capacity. This waste is



Proper range management makes sheep grazing in the forests profitable

being increased through fire and destructive lumbering by 10 to 15 million acres every year. Timber is being cut or destroyed four times as fast as timber is growing. Freight on lumber into States that have idle forest lands costs hundreds of millions of dollars every year. Fishing, hunting, and other recreational pursuits are everywhere subjected to sharp limitations. Because of devastated watersheds floods follow continued rains and bring damage beyond realization alike to town and farm, while cities run short of water during drought.

Things that hinder.—Timberland owners are unable to see profit in growing a crop that requires 150 to 200 years to mature and which will be harvested by a future generation. Distances between timber and transportation lines or markets, and lack of near-by market for by-products work in combination with rough topography and small number of trees per acre to prevent the manufacture of lumber cheap enough to carry the interest of the owner beyond the harvesting of the

present crop. Many operators are not owners and do their logging at the least possible cost without regard to the use to which the land may be put afterwards. Heavy grazing of forest lands, which can not be overcome at once because of enormous investments in range improvements that require long-continued use in order to pay out, interferes with the greatest production of timber. Forest fires, particularly those caused by human beings, constitute a tremendous obstacle in the way of successful management of both publicly and privately owned forest land, as years of effort may be lost in a few hours of conflagration.



Seed trees and proper disposal of brush make possible a new stand of timber after logging

FIRES: THE ARCH ENEMY OF FORESTS

From 500 to 1,000 fires are put out by Forest Service employees in the Southwest each year. Rangers and fire guards reach a great number of these fires and extinguish them while they are small, but each fire is a menace to public property and welfare.

Two-thirds of the fires are caused by lightning and are unavoidable. Those comprising the other third are due to carelessness and could be entirely eliminated if every citizen would regard the national property as he does his own house and would exercise the same care. The average person is not wilfully careless, but he is often woefully uninformed. It is for his benefit that the "Six rules" are given on page 16.

The damage wrought by crown fires—that is, fires that get into the tops and burn even the grown trees—is obvious and requires no comment. The blackened wastes speak for themselves, but the damage done by ground fires that burn only along the surface of the earth is less well known. These ground fires kill the little seedlings, and these little seedlings are the keystone of forestry. Especially is

this true in the Southwest, where the climate makes it exceedingly difficult to establish a natural growth of seedlings preparatory to the removal of the mature crop. Artificial planting of seedlings is almost prohibitive in cost, so that the ground fire that burns natural reproduction destroys the forest just as surely as if it consumed all the trees at once.

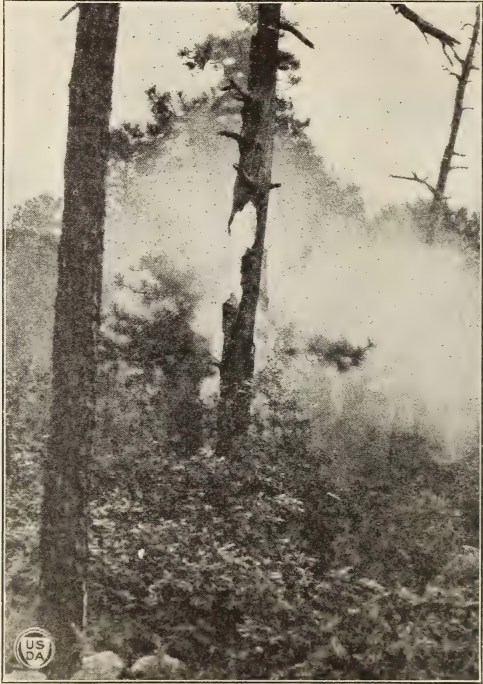

Fire, the arch enemy of the forest

Ground fires scar the bases of large trees and through these wounds enter fungous rots, which work invisibly in the tree and destroy its value for lumber. Every forest fire, whether severe or light, big or little, is a curse to the forest and the community, and an enemy to the public welfare.

PREVENT FOREST FIRES

CONCLUSION

The forest lands of the United States at work would mean settled communities and permanent industries. It would mean not only continuous supplies of lumber and other timber products for those who live close by, but a surplus for the farms and cities in the parts where timber is not grown. It would mean a decrease in flood menace through control of streamflow, and increased agricultural prosperity where land is irrigated. Wild plant and animal life could be established to the delight of a nature-loving public, while health giving recreation such as can be found only in forest and stream would be within reach of millions who need the out of doors.

In the Southwest the annual per capita consumption of timber and timber products is 500 board feet. Properly cut-over timberlands in this region can be made to produce a yearly growth of 50 to 100 board feet per acre (more favored regions runs three to five times as much). Ten acres of growing timber for each person would be required to supply the timber needs of the population, it is true, but with the 11,000,000 acres of forest land in Arizona and New Mexico managed so as to do their best there can be cut every year timber products sufficient to supply the common timber needs of a million people and the yield sustained in perpetuity.

Certainly agriculture in no part of the country can be benefited more by regulated streamflow and a consequent permanent supply of water for irrigation than in the southwest, where the greater part of the farming is dependent upon other moisture than direct rainfall. Future supplies of fish and game can be assured only through forest perpetuation. Recreation, essential to the health and happiness of southwestern people, reaches its ideal in forest cover on every forest acre.

Management of the country's forests is more than a local affair. Lands that are not fit for general farming but which will support trees become a public liability if not kept busy growing trees. It is a problem for the Nation. On its solution depends the stability of government and the progress of a great people. It is useless to grow timber and then burn it up in forest fires. Protection of the timber resources is a proposition too big for private enterprises to meet individually. Comprehensive plans in which the owner, and State, and Federal Governments work hand in hand offer the only hope of success. Management of forest lands so that they will be constantly productive should be made economically feasible by tax adjustment and whatever additional steps are locally necessary.

TREES

*I think that I shall never see
A poem lovely as a tree.
A tree whose hungry mouth is prest
Against the earth's sweet flowing breast;
A tree that looks at God all day,
And lifts her leafy arms to pray;
A tree that may in summer wear
A nest of robins in her hair;
Upon whose bosom snow has lain;
Who intimately lives with rain.
Poems are made by men like me,
But only God can make a tree.*

—Joyce Kilmer.

OUTSTANDING POINTS IN FOREST SERVICE HISTORY

On August 16, 1876, Congress appointed Dr. Franklin B. Hough as Commissioner of Forestry.

In 1877 Congress granted its first appropriation, \$6,000 for forestry purposes.

In 1881 the Division of Forestry was established in the Department of Agriculture as an information bureau only.

By act of Congress, March 3, 1891, the President was given power to establish forest reservations and President Harrison established the Yellowstone Park Timber Land Reserve.

The act of June 4, 1897, authorized the administration of the forest reserves, which were then under the Department of the Interior.

On July 1, 1898, there were 6 clerks and 6 scientific employees in the Division of Forestry.

The act of February 1, 1905, transferred the forest reserves and the authority to administer them from the Secretary of the Interior to the Secretary of Agriculture, and the work of the service as we know it to-day began. In July, 1905, the Bureau of Forestry became the Forest Service.

In 1907 the name of the forest reserves was changed to national forests to correct the impression that they were withdrawn from use.

In 1908 the direct administration of field work was transferred from Washington to six district headquarters in the West, and in 1914 a similar district was established in the Appalachian region, while district 8, comprising the Alaskan Forests, was created in 1921. National forests now number nearly 150 and embrace approximately 157,000,000 acres.

THE FOREST IS YOUR FRIEND

*The water you drink comes from it.
Nothing you use or wear could be yours without
the forest's help.
The forests are your playground.
They are wide open for you to fish, hunt, and
camp.*

—Gifford Pinchot.

THE FOREST FIRE IS YOUR ENEMY



Thousands of cattle graze in the meadows of the southwestern forests



Recreation grounds in the heart of the forest

SIX RULES FOR PREVENTION OF FOREST FIRES

1. **MATCHES.**—Be sure your match is out. Break it in two before you throw it away.

2. **TOBACCO.**—Be sure your pipe ashes, cigar or cigarette stubs are dead before throwing them away. Do not throw them into brush, leaves, or needles.

3. **MAKING CAMP.**—Build a small camp fire. Scrape away all trash and inflammable material from the spot. Build the fire in an open space and not against a tree or log or near brush. Scrape away the trash from around it.

4. **LEAVING CAMP.**—Never leave a camp fire unattended, even for a short time. Quench it with water or earth.

5. **BONFIRES.**—Never build bonfires in windy weather or where there is the slightest danger of their escaping from control.

6. **FIGHTING FIRES.**—If you find a fire, try to put it out. If you can't, get word of it to the nearest United States forest ranger at once. Keep in touch with the rangers.

If you desire information on roads, trails, camping places, hunting, fishing, timber, stock range, or summer home sites, **ASK THE FOREST RANGER.**

ADDITIONAL COPIES
OF THIS PUBLICATION MAY BE PROCURED FROM
THE SUPERINTENDENT OF DOCUMENTS
GOVERNMENT PRINTING OFFICE
WASHINGTON, D. C.
AT
5 CENTS PER COPY
▽

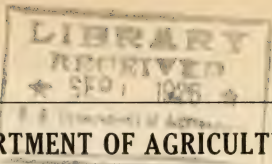

UNITED STATES DEPARTMENT OF AGRICULTURE

MISCELLANEOUS CIRCULAR NO. 16

WASHINGTON, D. C.

AUGUST, 1925

TREE DISTRIBUTION UNDER THE KINKAID ACT OF 1911

PREPARED BY THE FOREST SERVICE

Annually since 1911 the agricultural appropriation act has contained a provision for the free distribution of young trees from the Bessey Nursery, Nebraska National Forest, Halsey, Nebr., as follows:

That from the nurseries on the Nebraska National Forest the Secretary of Agriculture, under such rules and regulations as he may prescribe, may furnish young trees free, so far as they may be spared, to residents of the territory covered by "An act increasing the area of homesteads in a portion of Nebraska," approved April 28, 1904.

The act referred to is commonly known as the Kinkaid Act, and the portion of Nebraska included is shown on the map (fig. 1).

Under the foregoing provision, trees have been distributed as follows:

Year	Number of applicants	Number of trees distributed	Year	Number of applicants	Number of trees distributed
1912.....	494	44,460	1920.....	698	119,180
1913.....	540	189,000	1921.....	680	104,600
1914.....	712	248,500	1922.....	829	170,400
1915.....	746	112,110	1923.....	1,041	206,100
1916.....	770	131,200	1924.....	970	195,050
1917.....	704	127,550			
1918.....	586	122,900	Total.....	9,298	1,877,445
1919.....	528	106,395			

The reports sent in by those who have received the trees indicate that they obtain as high as 75 per cent survival in favorable seasons and as low as almost total failure in seasons of drought. An average of about 50 per cent of the trees planted live. Some planters who take unusually good care of their trees obtain almost perfect stands. There are scattered groves of trees all through western Nebraska, many of which were planted under the timber culture act of March 13, 1874, locally called the "tree claim" law.¹ Where

¹This law as amended by the act of June 14, 1878, authorized the entry of a quarter section or less of treeless land for the purpose of timber culture. The law required that the entryman should plant, protect, and keep in a healthy growing condition for 8 years 10 acres of timber on a quarter section, 5 acres on an 80, or 2½ acres on a 40-acre tract. No residence on the land was required.

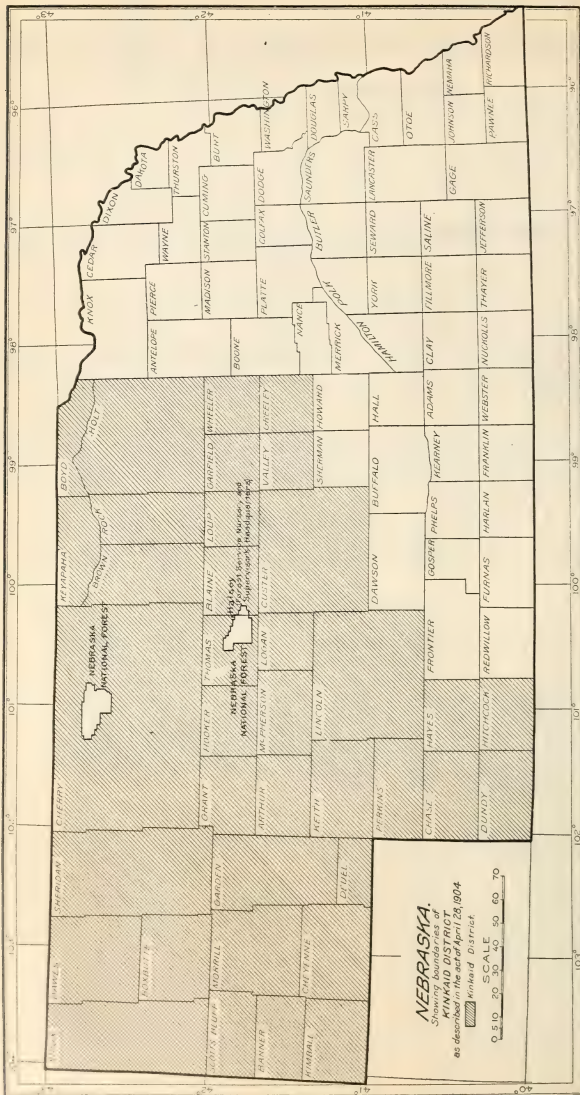

Fig. 1.—Map of Nebraska, showing the boundaries of the Kinkaid district

fire and stock have been kept out these wood lots are furnishing their owners with shelter for buildings and stock, as well as a supply of fuel and farm-repair material. (Figs. 2 and 3.)

Jack pines planted at Halsey in 1903 by the Forest Service had an average diameter at the end of 1924 of 4.8 inches at breast



FIG. 2.—Jack pine and cottonwood plantation protecting a farmhouse in Holt County, Nebr.

height—4½ feet above the ground—and an average height of 24 feet. (Fig. 4.) The maximum diameter and height is 6.1 inches and 32 feet. The accumulation of pine needles on the ground and the shading out of the grass and the lower branches of the trees indicate that forest conditions now prevail. Later plantations have



FIG. 3.—Cottonwood and western yellow pine planted on the north and west of a ranch house in Thomas County, Nebr.

had a survival of from 50 to 85 per cent on the roughest and lightest sand hills in the State. About 10,000 acres have been successfully planted here by the Federal Government, and it is evident that tree raising is no longer an experiment in this territory, formerly considered so inhospitable to tree growth.

OBJECTS OF TREE DISTRIBUTION AND PLANTING

The main object of the tree distribution by the Government is to stimulate interest in forest-tree growing, chiefly for the production of fuel and fence posts and the establishment of windbreaks. With proper care, woodlot plantations should begin to yield fence posts and firewood in 15 years. Since trees will do well on soils not suitable for farm crops, profitable use can be made of what might otherwise be unproductive areas. Furthermore, the establishment of windbreaks and wood lots makes living conditions pleasanter and adds materially to the value of the property.

THE SELECTION OF SITES FOR PLANTING

The influence of the site, such as north slope, south slope, ridge top, and bottom, strongly affects the growth of various trees species. It is probable that the greatest success will come from planting on the



FIG. 4.—Fifteen-year jack pine planted in the sand hills of the Nebraska National Forest, Thomas County, Nebr.

north slopes, where the soil is generally more moist and is protected to some extent from the drying heat of the sun. Frost leaves the ground on the north slopes a little later in the spring, but by the time the season is far enough advanced for planting (generally March 15 to 30) the soil will be in excellent condition for planting. Where the ground is level, or nearly so, the choice of site is, of course, not governed by topographical conditions; one place is as good as another.

WHEN TO PLANT

The rainfall at Halsey averages 21 inches a year, but in the extreme western portion of the State it amounts to only 15 inches.

The period from April 1 to June 30 is marked by more than the average rainfall. Records show that 42 per cent of the total rainfall for the whole year comes in the three months of April, May, and June. It is very important, therefore, to begin planting imme-

diately after the frost leaves the ground, so that the trees can get the full benefit of the spring rains

SPECIES TO PLANT

There are several trees suitable for planting in this district, and a brief discussion of the characteristics of each is given to assist the planter in selecting those which will best suit his particular needs.

Those which are likely to give the best satisfaction are the coniferous or "evergreen" trees. Western yellow pine, Scotch pine, Austrian pine, jack pine, and red cedar will grow in this region. Some of the hardwoods (deciduous or broadleaf trees) that will grow are cottonwood (fig. 5), American elm, honey locust, hackberry, green ash, Russian olive, Chinese elm, and black walnut.

Hardwoods require more moisture and better soil than pines, and also require cultivation to insure success. Most of the land in the Kinkaid district is characterized by a sandy soil which can not be



FIG. 5.—Cottonwood plantation at the University of Nebraska substation, North Platte, Nebr.

safely cultivated because of blowing. It is therefore obvious that pines, which do not have to be cultivated, are in general best suited to the region and that hardwoods should be employed only where the better grades of soil are found or where some local conditions favor their growth. In addition, evergreens make a more satisfactory wind-break, because the foliage remains on the trees throughout the year. The timber produced is also of better grade than that of the ordinary hardwoods grown in the sand hills.

The degree of success that will follow planting depends largely on the care exercised in selecting the site on which the trees are planted. Some trees will do better on a north slope, others on a ridge; most of the hardwood species will succeed best in the bottoms. The man who expects to get results must consider the requirements of the different species he is planting.

All of these species are not available every year, but so far as possible trees best suited to the land to be planted are sent to each applicant. No fruit trees are furnished from this nursery.

JACK PINE

Jack pine is hardy and rapid growing. It will grow on poor soil, but requires plenty of light. The wood is light, moderately strong, coarse grained, and suitable for rough construction and for posts when treated with a preservative material.

The jack pine will grow well even on south slopes where there is little moisture and where many other trees have failed. (Fig. 6.) From the standpoint of utility it is not the most desirable tree, but its ability to grow on poor soil makes it valuable. Because of its shallow-root system, it may die out during the periods of extreme drought in open stands where grass is abundant. Overcrowding also will cause the weaker trees to die. It can not be recommended for heavy loam or clay soils.

WESTERN YELLOW PINE

Western yellow pine is one of the hardiest of the trees that can be grown in this region. It will do well on ridges and north slopes



FIG. 6.—A ranch home in Loup County, Nebr. Pine trees in foreground distributed under the Kinkaid Act

or in the pockets, and responds to cultivation with increased growth. It thrives best in pure stands (that is, unmixed with other species) and grows rapidly enough to establish itself within a few years. It is probably the most valuable tree that can be grown in this part of the country and should give more uniform success than any other species. The growth for the first few years is slow, but after the fifth year it may grow from 12 to 18 inches annually. The growth of this tree is often set back by the pine-tip moth, an insect the larvae of which bores through the buds and tender shoots and kills them.

SCOTCH AND AUSTRIAN PINES

Scotch and Austrian pines have been planted extensively in the eastern and central parts of the State, and they will do well in the western half if planted on north and east exposures. If available, the Riga or northern European variety of Scotch pine should be planted. Scotch pine planted at Halsey on a north exposure aver-

aged, at the end of 18 years' growth, 3.9 inches in diameter at breast height and 22 feet in height. The maximum growth attained was 6.7 inches in diameter and 29 feet in height. Austrian pine is a slower growing species, but is very hardy and is practically immune to the attack of the pine tip moth. Scotch pine is not quite so resistant to the moth as Austrian. Both species will do well on sandy soil as well as on the heavier loam soils.

EASTERN RED CEDAR

Eastern red cedar occurs naturally in the river valleys and along the adjacent bluffs in central and western Nebraska. It is somewhat difficult to start from seed and does not transplant so readily as the other conifers. It makes a rapid growth. A windbreak in Holt County, planted in 1911 on a sandy flat, averaged 25 to 30 feet in height and 5.8 inches in diameter at the close of 14 years' growth. This species should not be planted close to orchards, because of the presence of the "cedar apple" fungus, which damages apple trees.

HARDWOODS

Hardwoods should be planted in heavier and moister soils than conifers, preferably in tilled bottoms. They should be cultivated until the trees have grown too large to work between the rows. Cottonwood makes a very good growth in this region, but it is short-lived and is subject to attacks of borers and to canker.

American elm, honey locust, and hackberry are well adapted to planting in this region because of their ability to grow on dry soils and to resist severe frosts without injury, but cultivation is necessary until the trees are well established. Russian olive adapts itself to arid soils. Green ash will grow on the moister situations, but its growth is slow and it is subject to attacks of insects.

Chinese elm is a very rapid growing and hardy tree wherever it has been planted in western Nebraska. Black walnut can also be successfully grown in well-protected valleys where the water level is not too far below the surface.

SHIPMENT AND CARE OF TREES

Trees may be shipped from the nursery by parcel post, provided stamps are sent to the forest supervisor, United States Forest Service, Halsey, Nebr., before February 1 of each year. Planters will be notified at least one month before this date of the amount of postage required. Unless mail shipment is requested the trees will be sent by express, charges collect.

The trees will be shipped in bundles that will allow free circulation of air to the tops. The roots will be packed in damp moss to prevent drying out. Young trees, especially pines, are very tender and susceptible to injury. If the roots are exposed to the air, even for only a few minutes, they are likely to be injured, or killed entirely. If special care is exercised in handling the stock, a more successful plantation will result. Trees should not be left around the depot or post office longer than is absolutely necessary. It is best to plant the trees immediately after receiving them. If this can

not be done, they should be stored in a cellar or some cool, moist place, or heeled in as shown in Figure 7. The tops of evergreens in packages should not be wet; if there is any danger of the roots becoming dry, they should be moistened not soaked. This can be done by pouring a small quantity of water over the stems at the top of the package, allowing it to trickle down into the roots and moss.

METHOD OF PLANTING

When ready to plant, the trees should be taken out of the package, or from the ground where they have been heeled in, and placed in a box or bucket which contains some of the moss in which the trees were originally packed. The roots should be surrounded by wet moss and the trees themselves covered with a piece of wet burlap. When planting, the trees should be drawn from the bucket or box one at a time and put into the ground with as little exposure as possible.

Care in planting trees is as important as care in handling them.

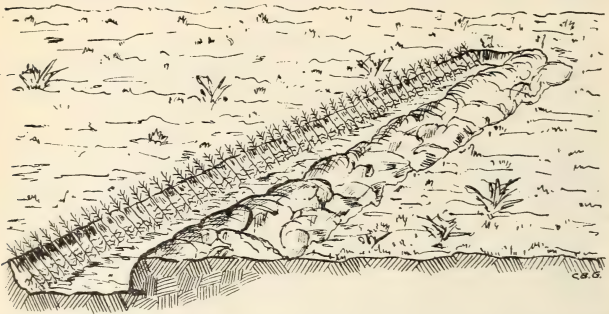

FIG. 7.—Heeling in. This should always be done if the trees can not be planted immediately. Dig trench in moist earth deep enough to bury the roots and part of the stems allowing the roots to hang down full length, covering each layer of roots as placed. Do not double or curl them. Each layer of roots should not be more than 2 inches deep and the thickness of the soil over the roots should always exceed the depth of the layer of the roots

If they are not given careful attention when they are set in the ground, they can not be expected to live. Correct and incorrect methods of planting are shown in Figure 8.

The best way to plant evergreens is to plow a furrow and place the trees in slits made with a spade, as shown by Figures 9 and 10. These furrows can be plowed in sod in the sand hill region where there is danger of soil blowing; and the trees will require no cultivation, unless the planter desires to stimulate their growth. Success in tree planting can not be expected if the trees are stuck in sod and left to care for themselves, for the grass will crowd them out. This grass competition is greatly reduced by plowing a furrow, the method used in the planting operations on the Nebraska National Forest. Trees planted in the heavier loam soils should always be cultivated.

Hardwoods, if small rooted, may be planted in furrows in the same manner as conifers, or, if roots are large, by the deep-hole

method, illustrated in Figure 11, but always in prepared ground. The hole should be large and deep enough to accommodate all the roots without crowding. Hold the tree upright with roots in natural position, and cover the roots with loose soil, tamping as shown. Watering at the time of planting is always advisable, especially in dry seasons and on sandy soils. Wind shields, such as shingles or narrow slats, set to protect the plant from the prevailing winds, are often necessary on exposed areas. Hardwoods should be cultivated for at least three years after planting, or until it is impossible to work between the rows.

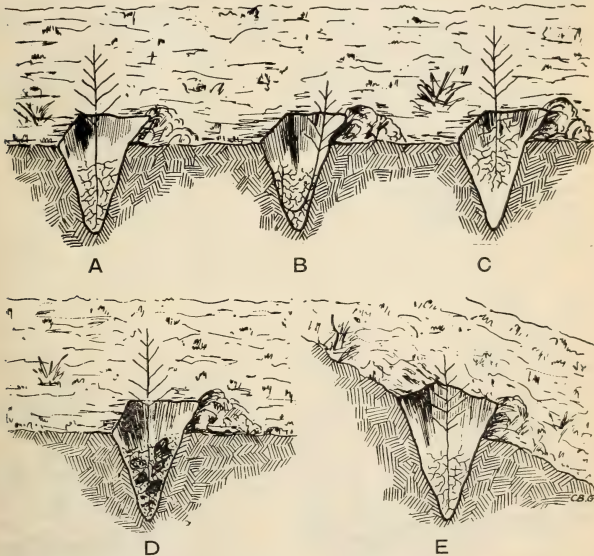

FIG. 8.—Correct and incorrect methods of planting. A.—Good planting; the tree will live if firmly set. B.—Careless planting; the tree, set too deep and the roots crowded, will very likely die. C.—Very careless planting; the tree is set too shallow; will surely die. D.—Careless planting; sod, grass, or dry sand tamped around roots will dry the roots, and the tree will die. E.—Careless planting; the tree if set too deep on a hillside will be covered by soil rolling from above

The trees should be planted in rows about 6 feet apart and spaced from 3 to 5 feet apart in the rows. This will give room enough for development and cultivation, and in normal years will not leave the trees too far apart if there are some losses.

PROTECTION OF THE PLANTATIONS

To prevent the destruction of the plantations by prairie fires a double firebreak should be plowed around the trees. If the trees are included within the firebreak plowed for the protection of the home property, an extra break is unnecessary.

A fence should be constructed to keep out cattle, horses, and other stock. This is a most important point, since stock are likely to trample or eat the young trees. Most plantations can not be grazed for several years after planting.

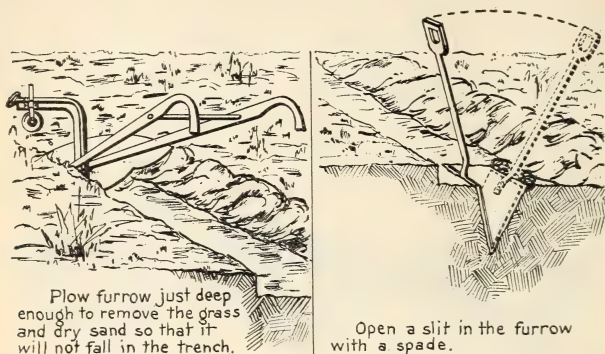

FIG. 9.—First steps in planting. Plant hardwoods on prepared ground and cultivate until trees have grown together so as to shade out the grass

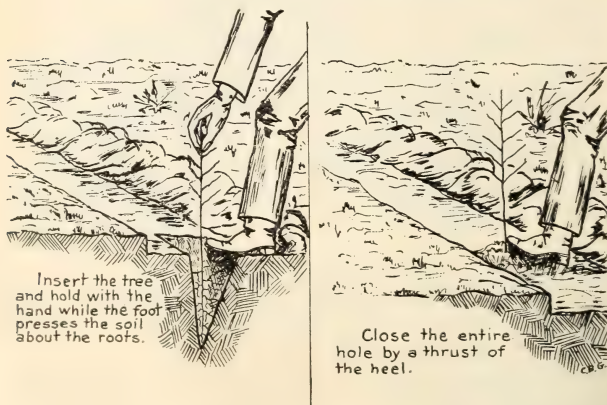

FIG. 10.—Successive steps in planting

Gophers probably destroy more trees than any other agent in western Nebraska. The young trees are often covered by the mounds thrown out by the gophers. The rodents also gnaw off the roots of trees that are up to 6 feet or more in height. When fresh gopher mounds are discovered among the trees, it is necessary to take action at once with traps or poison. Several good gopher traps are on the

market, and trapping is the surest method of exterminating these rodents.

Potatoes, carrots, or parsnips cut up into small pieces and sprinkled with powdered strychnine make a good poison bait. A small quantity of saccharine or oil of anise should also be added to disguise the bitter taste of the strychnine. The runways, which are usually 4 to 8 inches beneath the surface, can be located with an iron rod or probe. When found, drop one or two baits into the hole, without disturbing the soil any more than is necessary.

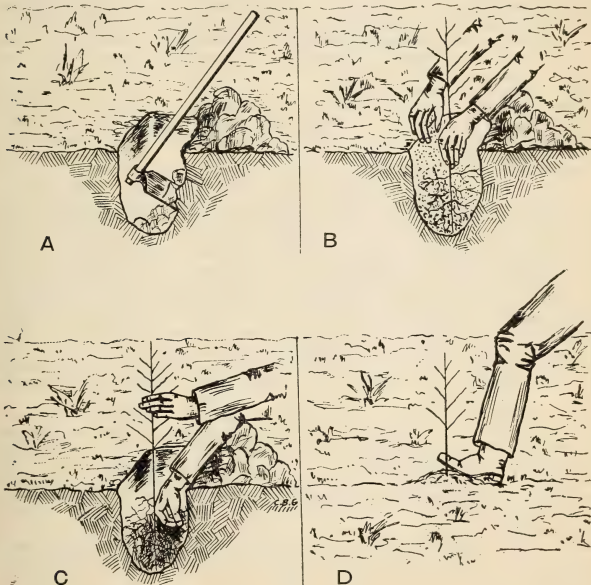

FIG. 11.—Deep-hole method of planting. This method should be used only when hardwoods are to be planted. A.—Dig the hole. B.—Partially cover the roots with loose moist earth. C.—Tamp the dirt firmly about the roots before filling the hole. D.—After filling the hole press the soil firmly about the roots by a thrust of the heel.

HOW TO OBTAIN TREES

Only the person owning or operating a farm may receive trees. Applications for trees from other members of the family on the farm will not be accepted.

A form of "Application and agreement" may be obtained from the forest supervisor, United States Forest Service, Halsey, Nebr. Before any trees are distributed this application must be properly filled out and signed. Upon the receipt of the signed agreement the supervisor will distribute the trees in proportion to the number of

applications and the quantity of nursery stock available. A sample form of the agreement follows:

Form 490.

APPLICATION AND AGREEMENT FOR YOUNG TREES, NEBRASKA NATIONAL FOREST

I, _____, a resident of that portion of Nebraska lying within the boundaries described in the act of April 28, 1904 (33 Stat., 547), entitled "An act to amend the homestead laws as to certain unappropriated and unreserved lands in Nebraska," under the provisions of the act of March 4, 1911 (36 Stat. 1235), entitled "An act making appropriations for the Department of Agriculture for the fiscal year ending June thirtieth, nineteen hundred and twelve," do apply for young trees for planting within the area above referred to.

The ground on which I desire to plant trees comprises an area of _____ acres, and is described as follows: Section _____, township _____, range_____.

Aspect: (Faces north, south, east, or west, or is it flat?)-----

Slope: (Steep or gentle?)-----

Grass and sod: (Heavy or light?)-----

Soil: (Loam, sandy loam, or sand?)-----

Cultivation: If hardwoods are desired, have you cultivated the ground on which to plant them?-----

The purpose of this planting is (shade, windbreak, or wood lot?)-----

In consideration of the granting of this application I promise and agree to plant all trees received by me and to care for them in the manner described in a circular of the Forest Service, Department of Agriculture, entitled "Tree Distribution Under the Kinkaid Act, 1911," and in accordance with any later instructions received by me from the Forest Service. I further promise to mail to the forest supervisor, Halsey, Nebr., on a card, Form 491, prepared for this purpose, not later than November 1 of each year, for three years after the date of the latest planting done by me, a statement showing the number of trees of each year's planting which are surviving in the area I have planted and the number of trees which I desire to plant during the following season. And I also agree to permit any representative of the Department of Agriculture to enter my premises at any reasonable time for the purpose of investigating the condition of the trees planted by me and the care which they have been given.

I further agree, immediately upon receipt of notice of shipment of any trees sent to me, to take them without delay from the post office or express or railroad company transporting them, and to pay all of the costs of their transportation, or to send stamps prior to February 1 of each year for their shipment by parcel post. If any package of trees is received by me in bad condition as a result of carelessness or long period in transit, I agree to accept the same without protest and immediately to notify the forest supervisor, Halsey, Nebr.

It is further agreed that if the trees received by me at any time are not planted, or are sold or otherwise disposed of, I am to forfeit the right to receive any more trees under the provision of the act of March 4, 1911, herein referred to.

(Signed) _____

Date _____.

Post office _____.

Express office _____.

New applicants will be supplied with not more than 200 trees, depending on the number available at the nursery. Those who have made good use of their trees may under certain conditions receive up to 500 trees. Those desiring more than this number must obtain them elsewhere, since it was not the intent of the act to have the Government furnish trees in large quantities to any one individual. The purpose of the distribution is to stimulate interest in tree planting.

A detailed report on the method of planting and the conditions under which planting was done should be made on a record card.

which will be sent to the applicant when the trees are shipped. This card, the form of which is here given, is to be mailed to the forest supervisor, Halsey, Nebr., as soon as planting has been done.

Form 492.

REPORT ON PLANTING

SPRING 19--

1. Date trees were received-----
2. Condition of trees when received-----
3. Species and number of each-----
4. If hardwoods were received, were they planted in prepared ground?-----
5. If so, how was ground prepared?-----
6. Were pines planted in furrows or unprepared ground?-----
7. Weather at time of planting-----
8. Method of planting-----
9. Date of planting-----
10. Has a fire guard been established?-----
11. Has a stock guard been built?-----
12. Remarks-----

This card should be mailed to the forest supervisor as soon after planting as possible, and in any event not later than May 1.

The agreement provides that the planter shall report annually for three years the number of trees surviving of each year's planting, and the form of card given herewith has been prepared for this purpose. This card should be filled out early in the fall, after the trees are planted, and returned to the supervisor.

Form 491 (revised).

Return card

FALL REPORT OF KINKAID PLANTING

Date of this report, -----, 19--

Number of trees living this fall from those planted			Total living from three seasons' planting
Year before last	Last year	This year	
-----	-----	-----	-----

Do you wish trees next spring?-----

Remarks-----

(Sign here)-----

(Address)-----

GENERAL INSTRUCTIONS

1. Applications for trees must be mailed to the forest supervisor, United States Forest Service, Halsey, Nebr., before February 1 of each year to receive consideration for the distribution of that year.
2. Form 492 should be mailed before May 1.
3. Form 491 should be mailed before November 1.
4. Mark the plantations of each year by setting stakes and marking them plainly "1924," etc., so that each year's planting may be identified.

5. Success in tree planting, like success in everything else, depends upon the care given to it. Do not allow the roots of the trees to become dry. Protect the trees from fire, stock, and gophers. Cultivate all hardwoods. Officers of the Forest Service will do all in their power to assist by advice and suggestions, but it must be borne in mind that constant care and attention on the part of the planter are necessary to success in tree planting, especially in the dry, sandy soils of the Kinkaid district.

ADDITIONAL COPIES
OF THIS PUBLICATION MAY BE PROCURED FROM
THE SUPERINTENDENT OF DOCUMENTS
GOVERNMENT PRINTING OFFICE
WASHINGTON, D. C.
AT
5 CENTS PER COPY

UNITED STATES DEPARTMENT OF AGRICULTURE

MISCELLANEOUS CIRCULAR No. 17

Washington, D. C.

April, 1924

LIST OF WORKERS IN
SUBJECTS PERTAINING TO AGRICULTURE

PART 2. State Agricultural Colleges and
Experiment Stations

Prepared by the Office of Experiment Stations
E. W. ALLEN, Chief

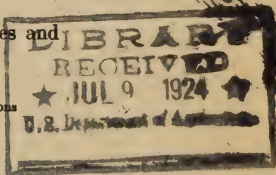

1923-1924



WASHINGTON
GOVERNMENT PRINTING OFFICE
1924

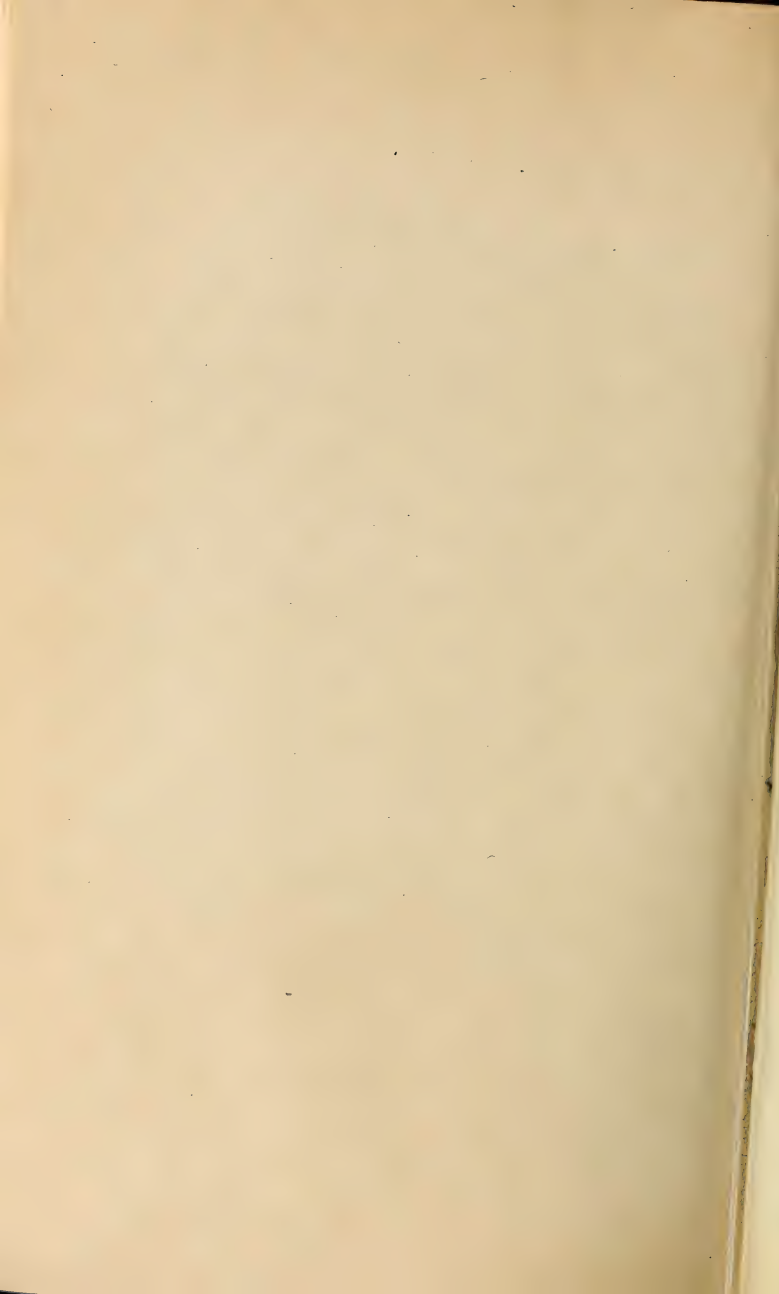

UNITED STATES DEPARTMENT OF AGRICULTURE

MISCELLANEOUS CIRCULAR No. 17

Washington, D. C.

April, 1924

LIST OF WORKERS IN
SUBJECTS PERTAINING TO AGRICULTURE

PART 2. State Agricultural Colleges and
Experiment Stations

Prepared by the Office of Experiment Stations
E. W. ALLEN, Chief

1923-1924



WASHINGTON
GOVERNMENT PRINTING OFFICE
1924



CONTENTS.

	Page.
Officers of the Association of Land-Grant Colleges.....	III
Key to abbreviations.....	IV
State agricultural colleges and experiment stations.....	1
Index of names.....	75

OFFICERS OF THE ASSOCIATION OF LAND-GRANT COLLEGES.

President: R. A. PEARSON of Iowa.

Vice President: G. I. CHRISTIE of Indiana.

Secretary-Treasurer: J. L. HILLS of Vermont.

Executive Committee: The President, *ex officio*, chairman; W. M. RIGGS¹ of South Carolina, A. F. WOODS of Maryland, A. R. MANN of New York, F. B. MUMFORD of Missouri, and W. B. BIZZELL of Texas.

OFFICERS OF THE SECTIONS.

Section of Agriculture: Chairman, B. H. CROCHERON of California.

Vice Chairman, C. A. McCUE of Delaware.

Secretary, F. W. PECK of Minnesota.

Subsection of Resident Teaching: Chairman, W. C. COFFEY of Minnesota.

Secretary, C. B. WALDRON of North Dakota.

Subsection of Experiment Station Work: Chairman, W. C. COFFEY of Minnesota.

Secretary, WILMON NEWELL of Florida; Recording Secretary, E. W. ALLEN of Washington, D. C.

Subsection of Extension Work: Chairman, H. C. RAMSOWER of Ohio.

Secretary, W. R. PERKINS of Louisiana.

Section of Engineering: Chairman, J. W. VOTEY of Vermont.

Secretary, C. R. JONES of West Virginia.

Section of Home Economics: Chairman, AGNES E. HARRIS of Alabama.

Secretary, EDITH P. CHACE of Pennsylvania.

STANDING COMMITTEES.

Committee on Instruction in Agriculture, Home Economics, and Mechanic Arts: For three years, A. C. TRUE of Washington, D. C., chairman; BERTHA M. TERRILL of Vermont, O. M. LELAND of Minnesota and J. H. SKINNER of Indiana; for two years, G. A. WORKS of New York, ANNA E. RICHARDSON of Iowa, and R. A. SEATON of Kansas; for one year, T. D. BOYD of Louisiana, ALFRED VIVIAN of Ohio, and NELLIE CROOKS of Tennessee.

Committee on College Organization and Policy: For three years, F. P. ANDERSON of Kentucky and BRADFORD KNAPP of Oklahoma; for two years, C. C. LITTLE of Maine and LOUISE STANLEY of Washington, D. C.; for one year, R. D. HETZEL of New Hampshire and C. A. LOBY of Colorado, chairman.

Committee on Experiment Station Organization and Policy: For three years, T. P. COOPER of Kentucky and H. G. KNIGHT of West Virginia; for two years, R. W. THATCHER of New York, chairman, and F. D. FARRELL of Kansas; for one year, B. YOUNGBLOOD of Texas and E. W. ALLEN of Washington, D. C.

Committee on Extension Organization and Policy: For three years, H. J. BAKER of New Jersey and W. H. BROKAW of Nebraska; for two years, G. I. CHRISTIE of Indiana and T. O. WALTON of Texas; for one year, B. H. CROCHERON of California and T. B. SYMONS of Maryland, chairman.

Committee on Military Organization and Policy: For three years, J. M. THOMAS of Pennsylvania and H. L. KENT of New Mexico; for two years, E. G. PETERSON of Utah and H. A. MORGAN of Tennessee; for one year, SAMUEL AVERY of Nebraska and W. M. RIGGS¹ of South Carolina.

Committee on Engineering Experiment Stations: For three years, G. W. BISSELL of Michigan; for two years, M. S. KETCHUM of Illinois; for one year, ANSON MARSTON of Iowa, chairman; and *ex officio*, the SECRETARY of the Section of Engineering.

JOINT COMMITTEES OF THE ASSOCIATION AND THE U. S. DEPARTMENT OF AGRICULTURE.

Committee on Projects and Correlation of Research: E. D. BALL, E. W. ALLEN, and W. A. TAYLOR of the U. S. Department of Agriculture; F. B. MUMFORD of Missouri, chairman; H. L. RUSSELL of Wisconsin, and B. L. HARTWELL of Rhode Island.

Editorial Committee, Journal of Agricultural Research: K. F. KELLERMAN, E. W. ALLEN, and C. L. MARLATT of the U. S. Department of Agriculture; J. G. LIPMAN of New Jersey, chairman; G. R. LYMAN of West Virginia, and H. W. MUMFORD of Illinois.

¹ Died January 22, 1924.

KEY TO ABBREVIATIONS.

- Acct.*, Accountant, Accounts.
Actg., Acting.
Admin., Administration, Administrative.
Agr., Agriculture, Agriculturist, Agricultural.
Agron., Agronomy, Agronomist.
Agt., Agent.
An., Animal.
Anal., Analytical, Analysis.
Anat., Anatomy.
Arch., Architecture.
Assoc., Associate, Association.
Asst., Assistant.
Bact., Bacteriology, Bacteriologist.
Biochem., Biochemist, Biochemistry.
Biol., Biology, Biologist, Biological.
Bot., Botany, Botanist, Botanical.
Brdg., Breeding.
Chair., Chairman.
Chem., Chemistry, Chemist, Chemical.
Climat., Climatology, Climatologist.
Coll., College.
Comp., Comparative.
Comm., Commission.
Comr., Commissioner.
Consult., Consulting.
Coop., Cooperation, Cooperative, Cooperator.
Corresp., Correspondence, Correspondent.
Dem., Demonstration, Demonstrator.
Dept., Department.
Dir., Director.
Dist., District.
Div., Division.
Dom., Domestic.
Econ., Economy, Economic, Economics.
Ed., Education.
Ele., Elementary.
Engin., Engineer, Engineering.
Ent., Entomology, Entomologist, Entomological.
Erad., Eradication.
Expt., Experiment, Experimentalist, Experimental.
Ext., Extension.
Fert., Fertility, Fertilizer.
Flor., Floriculture, Floriculturist, Floricultural.
For., Forestry.
Gard., Gardening.
Gen., General.
Geol., Geology, Geologist, Geological.
Grad., Graduate.
Histol., Histology.
Hon., Honorary.
Hort., Horticulture, Horticulturist, Horticultural.
Husb., Husbandry, Husbandman.
Hyg., Hygiene.
Indus., Industry, Industrial, Industries.
Inorg., Inorganic.
Insp., Inspection, Inspector.
Instr., Instruction, Instructor.
Insts., Institutes.
Invest., Investigations, Investigational.
Irrig., Irrigation, Irrigationist.
Lab., Laboratory.
Landsc., Landscape.
Lect., Lecturer.
Libr., Library, Librarian.
Mach., Machine, Machinery.
Mech., Mechanics, Mechanical.
Met., Meteorology, Meteorologist.
Mfg., Manufacturing.
Mfrs., Manufactures.
Mgr., Manager.
Mgt., Management.
Microbiol., Microbiology, Microbiologist.
Mycol., Mycology, Mycologist.
Nutr., Nutrition.
Oler., Olericulture, Olericulturist.
Org., Organic.
Organ., Organization.
Ornith., Ornithology, Ornithologist.
Parasitol., Parasitology, Parasitologist.
Path., Pathology, Pathologist.
Pedag., Pedagogy, Pedagogics.
Pharm., Pharmacy, Pharmacist, Pharmaceutical.
Pharmacol., Pharmacology, Pharmacologist.
Photog., Photography, Photographer.
Phys., Physics, Physical.
Physiol., Physiology, Physiologist, Physiological.
Pomol., Pomology, Pomologist, Pomological.
Pract., Practice, Practical.
Prep., Preparatory.
Pres., President.
Prin., Principal.
Prod., Production, Products.
Prof., Professor.
Pubs., Publications.
Sci., Science, Scientific.
Sec., Section.
Secy., Secretary.
Secun., Secondary.
Sociol., Sociology.
Sta., Station.
Substa., Substation.
Supt., Superintendent.
Supr., Supervisor.
Surg., Surgery.
Tech., Technology, Technologist, Technical.
Treas., Treasurer.
Trop., Tropical.
Univ., University.
Veg., Vegetable, Vegetation.
Vet., Veterinary, Veterinarian.
Vit., Viticulture, Viticulturist, Viticultural.
Voc., Vocational.
Zool., Zoology, Zoologist.

MEMORANDUM FOR THE RECORD

DATE: [illegible]

[The following text is extremely faint and illegible due to the quality of the scan. It appears to be a memorandum detailing a meeting or a set of instructions.]

STATE AGRICULTURAL COLLEGES AND EXPERIMENT STATIONS.

ALABAMA.

College of Agriculture and the Agricultural Experiment Station of the Alabama Polytechnic Institute, Auburn.

*College faculty. †Station staff. ‡Extension staff.

*Spright Dowell, M. A., LL. D., *President.*

*M. J. Funchess, M. S., *Actg. Dean Coll. of Agr., Actg. Dir. of Sta.*

‡L. N. Duncan, M. S., *Dir. of Ext. Service.*

*C. A. Cary, B. S., D. V. M., *Dean Coll. of Vet. Med.*

Agronomy: *†M. J. Funchess, M. S., *Head Prof.*

‡F. E. Boyd, M. S., *Ext. Agron.*

*D. J. Burleson, B. S., *Asst. Prof. Agron.*

*†F. W. Parker, Ph. D., *Asst. Prof. Agron.;*
Soil Chem.

*J. W. Tidmore, B. S., *Instr. Agron.*

†H. B. Tisdale, M. S., *Assoc. in Plant Brdg.*

†J. T. Williamson, B. S., *Supt. of Coop. Expts.*

Animal Industry: *††J. C. Grimes, M. S., *Head Prof.*

*†W. H. Eaton, B. S., *Assoc. Prof. Dairying;*
Dairyman.

*F. W. Burns, B. S., *Asst. Prof. An. Indus.*

‡William Hardie, B. S., *Dairy Specialist.*

‡J. E. Ivey, M. S., *Poultry Specialist.*

‡G. R. Riddell, A. N. *Husb. Specialist.*

†W. D. Salmon, M. A., *Asst. in An. Indus. Re-*
search.

Botany: *†W. A. Gardner, Ph. D., *Head Prof.* *Bot., Plant Physiol., Bot.*

*††L. E. Miles, Ph. D., *Prof. Plant Path.; Plant*
Path.

*†Martin Palmer, B. S., *Instr. and Asst. in Bot.*

*†C. C. Zeliff, M. S., *Asst. Prof. and Asst. Bot.*

Chemistry: *B. B. Ross, M. S., LL. D., *Head* *Prof. Gen. and Agr. Chem. (State Chem.).*

*†E. R. Miller, Ph. D., *Head Research Prof. and*
Research Chem.

†M. A. Barnes, B. S., *Asst. Research Chem.*

*C. A. Basore, M. S., *Asst. Prof. Chem.*

*C. L. Hare, M. S., *Prof. Phys. and Physiol.*
Chem.

*G. H. Marsh, M. S., *Asst. Prof. Org. Chem.*

*H. M. Martin, M. S., *Asst. Prof. Chem.*

*E. F. Pollard, M. S., *Instr. Chem.*

*P. P. Powell, M. S., *Assoc. Prof. Chem.*

Education (Agr.): *E. D. Stivers, B. S., *Prof.* *Agr. Ed.*

*S. L. Chesnutt, A. B., *Prof. Voc. Agr.*

Engineering (Agr.): *††M. L. Nichols, M. S., *Head* *Prof.*

*†E. C. Easter, M. S., *Instr. Agr. Engin. and*
Specialist in Visual Instruction.

†L. C. LeBron, B. S., *Agr. Engin. Specialist.*

*J. W. Randolph, M. S., *Asst. Prof. Agr. Engin.*

††P. T. Simons, B. S., C. E., *Drainage Engin.*
(Coop. U. S. D. A.).

Extension (Admin.): ¹ Director Duncan *in charge.*

†Agnes E. Harris, B. S., *State Home Dem. Agt.*

†May I. Cureton, *Asst. State Home Dem. Agt.*

†Helen Johnston, A. M., *Asst. State Home Dem.*
Agt.

†Elizabeth Mauldin, B. S., *Asst. State Home*
Dem. Agt.

†Gladys Tappan, *Asst. State Home Dem. Agt.*

Home Economics: *Agnes E. Harris, B. S., *Head of Dept.*

*Dana Gatchel, *Head Foods Dept.*

*Henrietta Thompson, *Head Clothing Dept.*

‡Josephine Eddy, *Clothing Specialist.*

‡Dora F. Sonnenday, *Nutr. Specialist.*

Horticulture: *†C. L. Isbell, M. S., *Actg. Head of* *Dept.*

†R. G. Briggs, A. M., *Hort. Specialist.*

*Otto Brown, M. S., *Asst. Prof. Hort.*

*L. M. Ware, B. S., *Instr. Hort.*

Rural Organization and Farm Management: *in charge.*

*†J. F. Duggar, M. S., *Research Prof. Farm Mgt.;*
Agr. Economist.

†K. G. Baker, B. S., *Marketing Specialist.*

†M. H. Pearson, B. S., *Marketing Specialist.*

¹ For subject-matter workers see the respective division, i. e., agronomy, animal industry, etc.

NOTE.—These lists, which were compiled by Mary A. Agnew and Betty T. Richardson, of the Office of Experiment Stations, include only names of persons directly engaged in teaching, investigation, or demonstration in agriculture and home economics.

An asterisk (*) indicates a college officer, a dagger (†) a station officer, and a double dagger (‡) an extension worker. When the title of the position in the station differs from that in the college the latter is given first, except in the case of the director of the station. A key to the abbreviations used is given on page IV.

LIST OF WORKERS IN AGRICULTURE.

Veterinary Medicine: *†C. A. Cary, B. S., D. V. M., *Dean Coll. of Vet. Med.; Vet. (State Vet.). Dir. Farmers' Insts.*
 *P. F. Bahnsen, V. S., *Lect. on Phys. Diagnosis.*
 *N. G. Covington, D. V. M., M. D. C., *Asst. Prof. Physiol. and Vet. Diagnosis.*
 *I. S. McAdory, B. S., D. V. M., *Prof. Vet. Sci.*
 *D. J. Meador, B. S., D. V. M., *Lect. on Hyg. and Sanitation.*
 *F. D. Patterson, jr., D. V. M., *Asst. Prof. Vet. Med.*
 *R. S. Sugg, B. S., D. V. M., *Asst. Prof. Bact. and Path.*
 *E. S. Winters, B. S., D. V. M., *Lect. on Anti-Hog Cholera Serum.*

Zoology and Entomology: *†F. L. Thomas,¹ Ph. D., *Actg. Head Prof. Zool. and Ent.; Acty. Ent.*
 *F. E. Guyton, M. S., *Asst. Prof. Zool. and Ent.*
 *†J. M. Robinson, M. A., *Assoc. Prof. Zool., Ent.; Asst. Ent.*

Miscellaneous:

††P. O. Davis, B. S., *Editor.*
 *†M. A. Glenn, *Treas.*
 *†Mary E. Martin, *Libr.*

Canebrake Agricultural Experiment Station, Uniontown.

†W. A. Cammack, B. S., *Director.*

Agricultural and Mechanical Institute for Negroes, Normal.

*Agricultural faculty. †Extension staff.

*T. R. Parker, A. M., *President.*

*Mrs. D. W. Adair, *Supvr. Home Econ.*

*Mrs. J. L. Bray, *Laundrying.*

*Cleveland Buchanan, *Voc. Agr.*

†E. C. Dobbs, *Agr. Dem. Agt.*

†W. T. Gravitt, *Agr. Dem. Agt.*

*Mrs. Maggie W. Jones, *Home Econ.*

*Adline Robinson, *Nursing.*

*Mrs. E. P. Selby, *Home Econ.*

†Miss M. L. Snipes, *Home Econ. Ext.*

Agricultural School and Agricultural Experiment Station of the Tuskegee Normal and Industrial Institute, Tuskegee Institute.

*College faculty. †Station staff. ‡Extension staff.

*R. R. Moton, LL. D., *Principal.*

*B. F. Hubert, B. S., *Dir. of Agr. Dept.*

†G. W. Carver, M. S., *Dir. of Sta. and Consult. Chem.*

‡C. J. Calloway, B. A., *Dir. of Ext. Dept.*

*C. L. Abbott, B. S., *Biol., Bact.*

*Rhena A. Banks, *Farm Accts.*

*H. B. Benson, *Swine Herd.*

*J. H. Bias, D. V. M., *Vet. Sci.*

†T. M. Campbell, *Supt. U. S. Farm Dem.*

*T. N. Cowen, *Farm Mgt.*

*Annie P. Crews, *Dom. Sci.*

†G. W. Goodwin, *U. S. Farm Dem.*

*E. A. Grant, L. I., *Dairy Herd and Creamery.*

*F. L. Green, M. S., *Home Econ., Dom. Sci.*

*W. W. Hayes, *Truck Gard.*

†Rosa B. Jones, *State Home Dem. Agt.*

†C. M. Kynette, *State Club Agt.*

*C. A. Lancaster, *Poultry Work.*

*Caroline C. Owens, *Home Planning and Furnishing.*

*Ophelia Pearson, *Sewing.*

*Hattie Reynolds, *Plain Sewing and Dress-making.*

*S. B. Simmons, B. Agr., *Teacher Training in Agr.*

†Harry Simms, *State Club Agt.*

*Motta L. Sims, B. A., *Dom. Sci.*

*Julia Skinner, *Ladies' Tailoring and Advance Dressmaking.*

*Ernestine Suarez, *Libr.*

*D. B. Taylor, B. S., *Agr. Chem.*

*V. C. Turner, B. S., *Farm Mgt. and An. Husb.*

*Susie M. Waggener, *Dom. Sci.*

*Mrs. B. T. Washington, M. A., *Dir. Women's Industries.*

*†L. J. Watkins, *Forest and Grounds.*

*†J. E. Whitfield, *Asst. Dir. of Agr. Dept.*

*D. A. Williston, B. S., *Dir. Dept. of Landsc. Gard.*

*†Matthew Woods, *Horse and Mule Husb.*

ALASKA.**Alaska Agricultural College and School of Mines (Divisions of Agriculture and Home Economics), Fairbanks.**

*Agricultural faculty.

*C. E. Bunnell, A. M., *President.*

*Elizabeth E. Kirkpatrick, M. S., *Prof. Home Econ.*

*C. H. Morgan, M. S., *Prof. Agr.*

¹ Goes to Texas station May 1, 1924.

Agricultural Experiment Stations, Sitka, Kodiak, Rampart, Fairbanks, and Matanuska.

Under the supervision of the Office of Experiment Stations, United States Department of Agriculture.

†Station staff.

†C. C. Georgeson, Sc. D., *Agronomist in charge, Sitka.*†E. M. Floyd, *Asst. in charge, Rampart.*†G. W. Gasser, B. S., *Asst. in charge, Fairbanks.*†Hans Lindberg, *Asst. at Sitka.*_____, *Asst. in charge, Matanuska.*†M. D. Snodgrass, B. S., *Agt. in Dem. and Ext. Work (P. O., Matanuska).*†H. O. White, *Asst. at Kodiak.*†W. T. White, B. S., *Asst. in charge, Kodiak*

ARIZONA.

College of Agriculture, the Agricultural Experiment Station, and the Agricultural Extension Service of the University of Arizona, Tucson.

*College faculty. †Station staff. ‡Extension staff.

*C. H. Marvin, Ph. D., LL. D., *President of University.**†J. J. Thornber, A. M., *Dean Coll. of Agr., Dir. of Sta. Bot. (†).*†P. H. Ross, B. S., *Dir. of Ext. Service.*G. M. Butler, E. M., Sc. D., *Dean Coll. of Engin.***Agronomy:** *†R. S. Hawkins, M. S., *Asst. Prof. and Actg. Agron.**†W. E. Bryan, M. S., *Prof. Plant Brdg.; Plant Breeder.**I. A. Briggs, M. S., *Instr. Agron.**†S. P. Clark, B. S., *Asst. Prof. and Asst. Agron.**†E. H. Pressley, B. S., *Asst. Prof. and Asst. in Plant Brdg.***Animal Industry:** *†W. S. Cunningham, B. S., *Prof. Dairy Husb.; Dairy Husb.**†Harry Embleton, B. S., *Assoc. Prof. and Poultry Husb.**†E. B. Stanley, M. S., *Asst. Prof. and Actg. An. Husb.**†R. H. Burns, M. S., *Asst. Prof. and Asst. An. Husb.**†R. N. Davis, B. S., *Asst. Prof. and Asst. Dairy Husb.*†C. U. Pickrell, B. S., *Ext. An. Husb. (P. O., Prescott).***Biology:** *†C. T. Vorhies, Ph. D., *Prof. Ent.; Ent.**†J. G. Brown, M. S., *Prof. Plant Path.; Plant Path.**G. T. Caldwell, B. S., *Asst. Prof. Biol.**H. D. Clayberg, Ph. D., *Asst. Prof. Biol.**Mary H. Estill, M. S., *Instr. Biol.**† ———, *Instr. and Asst. Plant Path.*†D. A. Gilchrist, B. S., *Rodent Control Specialist (Coop. U. S. D. A.).**A. F. Hemenway, Ph. D., *Assoc. Prof. Bot.***Chemistry:** *†C. N. Catlin, A. M., *Assoc. Prof. and Agr. Chem.**T. F. Buehrer, Ph. D., *Asst. Prof. Chem.**H. W. Estill, M. S., *Asst. Prof. Chem.**L. E. Roberts, Ph. D., *Assoc. Prof. Chem.**†A. E. Vinson, Ph. D., *Asst. Prof. and Asst. Agr. Chem.***Education (Agr.):** *E. D. Doxsee, M. S., *Asst Prof. and Chief.**Albert Barnett, A. M., *Asst. Prof. Agr. Ed.***Engineering (Agr.):** *†G. E. P. Smith, B. S. C. E., *Prof. Irrig. Engin.; Irrig. Engin.*†W. E. Code, B. S. C. E., *Asst. Irrig. Engin.**†H. C. Schwalen, B. S., *Instr. Irrig. Engin.; Asst. in Engin.***Extension (Admin.):** † Director Ross in charge and County Agt. Leader.†A. B. Ballantyne, B. S., *Asst. County Agt. Leader.*†Mrs. Mary P. Lockwood, B. S., *Asst. State Home Dem. Leader.***Home Economics:** *Nina B. Crigler, M. A., *Prof. Home Econ.**DeRosette Thomas, B. S., *Prof. Home Econ.**Anna B. Anderson, *Instr. Home Econ.**Kate L. Bear, A. M., *Asst. Prof. Home Econ. Ed.**Bertha F. Lent, M. A., *Asst. Prof. Home Econ.**Gladys Webster, M. A., *Instr. Home Econ.***Horticulture:** *†F. J. Crider, M. S., *Prof. Hort.; Hort.**†D. W. Albert, B. S., *Asst. Prof. and Asst. Hort.*†A. F. Kinnison, B. S., *Ext. Hort.***Miscellaneous:***†C. Z. Leshner, B. S., *Editor.**Estelle Luttrell, A. B., *Libr.***Substations:**Prescott Dry Farm, P. O. Prescott—C. W. Clark, B. S., *Foreman.*Salt River Valley Farm, P. O. Mesa—C. J. Wood, *Foreman.*Sulphur Spring Valley Dry Farm, P. O., Cochise—F. G. Gray, *Foreman.*Tempe Date Palm Orchard, P. O., Tempe—T. L. Stapley, *Foreman.*Yuma Valley and Mesa Farms, P. O., Yuma—Leslie Beaty, B. S., *Foreman.*

† For subject-matter workers see the respective division, i. e., agronomy, animal industry, etc.

ARKANSAS.

College of Agriculture and the Agricultural Experiment Station of the University of Arkansas,
Fayetteville.

*College faculty. †Station staff. ‡Extension staff.

*J. C. Futrall, M. A., LL. D., *President of the University.*

*†Dan T. Gray, M. S., *Dean Coll. of Agr., Dir. of Sta., Dir. Agr. Ext. Service.*

- Agronomy:** *†Martin Nelson, M. S., *Head of Dept.*
 *†R. H. Austin, B. S., *Instr. and Asst. Agron.*
 *G. H. Cady, Ph. D., *Prof. Geol.*
 *†C. K. McClelland, M. S., *Asst. Prof. and Asst. Agron.*
 *†L. W. Osborn, B. S., *Asst. Prof. and Asst. Agron.*
 *†W. H. Sachs, M. S., *Assoc. Prof. and Asst. Agron. (Soils).*
 *†J. O. Ware, M. S., *Asst. Prof. and Asst. Agron.*
- Animal Husbandry and Dairying:** *†H. E. Dvorachek, B. S., *Head of Dept.*
 *†Edgar Martin, B. S., *Asst. Prof. and Asst. An. Husb. (Beef Cattle and Horses).*
 *†R. H. Mason, B. S., *Asst. Prof. and Asst. An. Husb. (Dairying).*
 †M. W. Muldrow, *Livestock Specialist (P. O., Little Rock).*
 *†H. A. Sandhouse, M. S., *Assoc. Prof. and Asst. An. Husb.*
 *†S. R. Stout, B. S., *Asst. Prof. and Asst. An. Husb. (Poultry).*
 *†W. C. Wilbanks, B. S., *Instr. and Asst. in Dairying.*
 †W. H. Woodley, B. A., *Dairy Specialist.*
- Bacteriology:** *†W. L. Bleecker, D. V. M., *Head of Dept.*
- Chemistry:** *†J. W. Read, M. S., *Head Dept. of Agr. Chem.*
 *†Barnett Sure, Ph. D., *Assoc. Prof. and Asst. Agr. Chem.*
 *Harrison Hale, Ph. D., *Prof. Chem.*
 *G. E. Ripley, M. S., *Prof. Phys.*
- Economics (Agr.):** *J. S. Waterman, M. A., J. D., *Head of Dept., Prof. Econ. and Sociol.*
 †E. A. Hedson, M. S., *Agt. in Cotton Marketing Dem.*
 *A. W. Jamison, Ph. D., *Assoc. Prof. Econ. and Sociol.*
 *†A. D. McNair, *Prof. and Specialist in Farm Mgt. (Coop. U. S. D. A.).*
- Education (Agr.):** *E. B. Matthew, M. S., *Head of Dept.*
 *T. A. Fritts, M. S., *Assoc. Prof. Agr. Ed.*
- Engineering (Agr.):** *†D. G. Carter, B. S. A. E., *Head of Dept.*
- Entomology:** *†W. J. Baerg, Ph. D., *Head of Dept.*
 †R. L. Anderson, *Predatory An. Control Specialist (P. O., Little Rock).*
 *S. C. Dellinger, M. A., *Prof. Zool.*
 *†Dwight Isely, M. A., *Assoc. Prof. and Assoc. Ent.*
- Extension (Admin.):**¹ Director Gray in charge.
 †T. R. Reid, *Asst. Dir. (P. O., Little Rock).*
 †Connie J. Bonslagel, A. B., *State Home Dem. Agt. (P. O., Little Rock).*
 †W. J. Jernigan, B. A., *State Boys' and Girls' Club Leader (P. O., Little Rock).*
- Home Economics:** *Stella Palmer, M. A., *Head of Dept., Prof. Home Econ. Ed.*
 *Leona T. Bowman, Ph. D., *Asst. Prof. Home Econ. (P. O., Little Rock).*
 †Gertrude E. Conant, B. A., *Nutr. Specialist (P. O., Little Rock).*
 †Miss Leo Griffin, *Clothing Specialist (P. O., Little Rock).*
 *Madge Johnson, B. S., *Asst. Prof. Home Econ.*
 †Ruby Mendenhall, *Home Econ. Specialist.*
 *M. Agnes Nelson, Ph. B., *Instr. Home Econ.*
 †Em. Patty, *Textile and Clothing Specialist.*
 *Carrie Plunkett, B. S., *Instr. Home Econ.*
- Horticulture:** *†J. R. Cooper, M. S., *Head of Dept.*
 *†C. W. Rapp, M. S., *Assoc. Prof. and Asst. Hort.*
 *†O. W. Rowland, B. S., *Instr. and Asst. Hort.*
 †Claude Woolsey, M. S., *Ext. Hort.*
- Plant Pathology:** *†V. H. Young, Ph. D., *Head of Dept.*
 *J. T. Buchholz, Ph. D., *Prof. Bot.*
 *†H. R. Rosen, Ph. D., *Assoc. Prof. and Assoc. Plant Path.*
- Veterinary Science:** †J. H. Bux, D. V. M., *Head of Dept. (State Vet.: P. O., Little Rock).*
 *†S. J. Schilling, B. S., D. V. M., *Assoc. Prof. and Asst. Vet.*
- Miscellaneous:**
 †Violet Craig, *Asst. Ext. Editor.*
 †R. L. Foster, *Ext. Editor.*
 *†Margaret Gallaway, *Libr.*

State Agricultural, Mechanical, and Normal School, Pine Bluff.

*Agricultural faculty.

*R. E. Malone, *Superintendent.*

*W. L. Webb, *Dir. Agr. Dept.*

*Ada B. Anderson, *Asst. Home Econ.*

*W. A. Marks, *Prof. Chem. and Biol.*

*Lenora A. Patton, *Dir. Home Econ.*

*Lena Plantevigne, *Asst. Home Econ.*

*C. S. Woodward, *Teacher Training in Agr Work.*

¹ For subject-matter workers see the respective division, i. e., agronomy, animal husbandry, etc

CALIFORNIA.

College of Agriculture and the Agricultural Experiment Station of the University of California,¹
Berkeley.

*College faculty. †Station staff. ‡Extension staff.

*W. W. Campbell, Sc. D., LL. D., *President of University.*

*E. D. Merrill, M. S., *Dean Coll. of Agr., Prof. Agr.*

*†C. M. Haring, D. V. M., *Actg. Dir. Agr. Expt. Sta., Prof. Vet. Sci.*

‡B. H. Crocheron, M. S., *Dir. Agr. Ext. Service.*

*†H. J. Webber, Ph. D., D. Agr., *Dean School of Trop. Agr., Dir. Citrus Expt. Sta.*

*†C. B. Hutchison, M. S., *Dir. Branch of Coll. of Agr., P. O., Davis.*

C. L. Cory, M. M. E., D. Eng., *Dean Coll. of Mech.*

Agriculture: *T. F. Hunt, D. Agr., D. Sc., *Prof. Agr.*

Agronomy: *†J. W. Gilmore, M. S., *Head Div. of Agron.*

*†D. R. Hoagland, M. S., *Head Div. of Plant Nutr.*

*†C. F. Shaw, B. S., *Head Div. of Soil Tech.*

*J. S. Burd, B. S., *Prof. Plant Nutr.*

*†J. P. Conrad, B. S., *Assoc. in Agron. (P. O., Davis).*

†S. W. Cosby, B. S., *Research Assoc. in Soils.*

*†A. R. Davis, Ph. D., *Asst. Prof. Plant Nutr.*

†J. A. Denny, *Foreman in Cereal Work (P. O., Fresno).*

†W. H. Dore, B. S., *Asst. Prof. Plant Nutr.*

*J. F. Duggar, M. S., *Lect. in Agron. (P. O., Davis).*

*†W. F. Gericke, Ph. D., *Asst. Prof. Plant Nutr.*

*†G. W. Hendry, B. S., *Asst. Prof. Agron. (P. O., Davis).*

*†P. L. Hibbard, B. S., *Asst. Prof. Plant Nutr.*

*†P. B. Kennedy, Ph. D., *Assoc. Prof. Agron.*

*C. B. Lipman, Ph. D., *Prof. Plant Nutr.*

*†W. W. Mackie, M. S., *Asst. Prof. Agron.*

*†B. A. Madson, B. S., *Asst. Prof. Agron.*

*†J. C. Martin, B. S., *Instr. Plant Nutr.*

*†Allred Smith, M. A., *Asst. Prof. Soil Tech. (P. O., Davis).*

*†R. E. Storie, B. S., *Asst. in Soil Tech. (P. O., Davis).*

*†T. F. Tavernetti, B. S., *Asst. Prof. Farm Pract. (P. O., Davis).*

†W. W. Weir, *Asst. Prof. Soil Tech.*

*†E. V. Winterer, M. S., *Asst. in Soil Tech.*

Animal and Dairy Industry: *†G. H. True, B. S., *Head Div. of An. Husb. (P. O., Davis).*

*†C. L. Roadhouse, D. V. M., *Head Div. of Dairy Indus. (P. O., Davis).*

*†W. A. Lippincott, Ph. D., *Prof. Poultry Husb. (P. O., Davis).*

†F. H. Abbott, B. S., *Specialist in Butter Standardization (Coop. U. S. D. A.).*

†J. C. Corl, D. V. M., M. S., *Poultry Invest. (P. O., Petaluma).*

*†J. E. Dougherty, B. S., *Assoc. Prof. Poultry Husb. (P. O., Davis).*

†R. B. Easson, B. S., *Poultry Specialist.*

†A. W. Farrell, M. S., *Asst. in Dairy Indus. (P. O., Davis).*

†A. H. Folger, B. S., *in charge Advanced Registry Work (P. O., Davis).*

Animal and Dairy Industry—Continued.

*†C. E. Howell, M. S., *Asst. Prof. An. Husb. (P. O., Davis).*

*†E. H. Hughes, M. S., *Assoc. Prof. An. Husb. (P. O., Davis).*

*†W. E. Lloyd, B. S., *Asst. Prof. Poultry Husb. (P. O., Davis).*

†O. L. Lovejoy, B. S., *Asst. An. Husb. in charge Range Cattle Expts. (P. O., Shingle Springs).*

†R. F. Mead, M. S., *Asst. in An. Husb. (P. O., Davis).*

*†R. F. Miller, M. S., *Assoc. Prof. An. Husb. (P. O., Davis).*

*†C. S. Mudge, Ph. D., *Asst. Prof. Dairy Indus. (P. O., Davis).*

‡Noel Negley, M. S., *Dairy Specialist.*

‡W. E. Newlon, B. S., *Poultry Specialist.*

*Sylvia L. Parker, A. B., *Instr. Poultry Husb. (P. O., Davis).*

*†C. A. Phillips, B. S., *Assoc. in Dairy Indus. (P. O., Davis).*

†L. A. Raffetto, B. S., *Asst. in Dairy Indus. (P. O., Davis).*

*†W. M. Regan, A. M., *Assoc. Prof. An. Husb. (P. O., Davis).*

†C. E. Tegner, B. S., *Asst. in Dairy Indus. (P. O., Davis).*

*†W. E. Tomson, B. S., *Assoc. in An. Husb. (P. O., Davis).*

*†G. D. Turnbow, M. S., *Asst. Prof. Dairy Husb. (P. O., Davis).*

*†H. E. Van Norman,² B. S., *Prof. Dairy Mgt.*

*†E. C. Voorhies, B. S., *Asst. Prof. An. Husb. and Asst. to Dean of Coll.*

*†J. F. Wilson, M. A., *Asst. Prof. An. Husb. (P. O., Davis).*

Botany: *†W. A. Setchell, Ph. D., *Prof. Bot.*

*†H. S. Reed, Ph. D., *Prof. Plant Physiol. (P. O., Riverside).*

†H. A. Borthwick, A. B., *Asst. in Bot. (P. O., Davis).*

*†A. R. C. Haas, Ph. D., *Asst. Prof. Plant Physiol. (P. O., Riverside).*

†F. F. Halm, B. S., *Research Assoc. in Plant Physiol. (P. O., Riverside).*

*R. M. Holman, Ph. D., *Asst. Prof. Bot.*

*†W. W. Robbins, Ph. D., *Assoc. Prof. Bot. (P. O., Davis).*

Chemistry: *†W. P. Kelley, Ph. D., *Prof. Agr. Chem. (P. O., Riverside).*

*†C. S. Bisson, Ph. D., *Prof. Chem. (P. O., Davis).*

†S. M. Brown, *Asst. Chem. (P. O., Riverside).*

¹ This institution gives the academic title to all employees.

² On leave.

Chemistry—Continued.

- *†A. B. Cummins, B. S., *Asst. in Agr. Chem. (P. O., Riverside).*
 *J. G. Sewell, B. S., *Instr. Chem. (P. O., Davis).*
 †E. E. Thomas, B. S., *Research Assoc. in Agr. Chem. (P. O., Riverside).*

Economics (Rural): *†Elwood Mead, D. E., *Head Div. of Rural Institutions.*

- *†R. L. Adams, M. S., *Head Div. of Farm Mgt.*
 *W. R. Camp, Ph. D., *Assoc. Prof. Rural Institutions.*
 †W. T. Clarke, B. S., *Public Service Specialist.*
 †C. F. Elwood, B. S., *Public Service Specialist.*
 *†H. E. Erdman, Ph. D., *Assoc. Prof. Rural Institutions.*
 †L. W. Fluharty, B. S., *Farm Mgt. Dem.*

*†S. W. Shear, M. S., *Assoc. in Rural Institutions.*
Education (Agr.): *†F. L. Griffin, M. S., *Head of Div.*

*B. R. Crandall, D. Ped., Ph. D., *Asst. Supvr. Agr. Teacher Training.*

*W. E. Berg, B. S., *Assoc. in Agr. Ed.*

*H. M. Butterfield, M. S., *Corresp. Teacher in Agr. Ed.*

*†O. J. Kern, *Asst. Prof. Agr. Ed.*

Engineering (Agr.): *†L. J. Fletcher, B. S., *Head of Div. (P. O., Davis).*

†Frank Adams, A. M., *Head of Irrig. Invest. (Coop. U. S. D. A.: P. O., Davis.)*

*†S. H. Beckett, B. S., *Assoc. Prof. Irrig. Pract. (P. O., Davis).*

*†H. L. Belton, *Assoc. in Agr. Engin. (P. O., Davis).*

†J. B. Brown, B. S., *Irrig. Specialist. (P. O., Davis).*

†Frank Davis, B. S., *Asst. in Irrig. Pract. (P. O., Davis).*

†C. F. Dunshee, B. S., *Assoc. in Irrig. (P. O., Davis).*

†J. P. Fairbank, B. S., *Agr. Engin. Specialist.*

†A. H. Hoffman, E. E., *Asst. Prof. Agr. Engin. (P. O., Davis).*

†M. R. Huberty, B. S., *Asst. in Irrig. Invest.*

†C. N. Johnston, B. S., *Asst. in Irrig. Invest.*

*James Koeber, B. S., *Instr. Farm Mech. (P. O., Davis).*

†J. D. Long, B. S., *Asst. in Agr. Engin. (P. O., Davis).*

†E. G. McKibben, B. S., *Asst. in Agr. Engin. (P. O., Davis).*

*†B. D. Moses, B. S., *Asst. Prof. Agr. Engin. (P. O., Davis).*

*E. J. Stirniman, M. S., *Instr. Agr. Engin. (P. O., Davis).*

*†C. M. Titus, M. A., *Asst. Prof. Irrig. Invest. (P. O., Davis).*

*†F. J. Veihmeyer, C. E., *Asst. Prof. Irrig. Invest. (P. O., Davis).*

*†H. A. Wadsworth, B. S., *Asst. Prof. Irrig. Invest. (P. O., Davis).*

†W. L. Zink, B. S., *Asst. in Agr. Engin. (P. O., Davis).*

Entomology: *†W. B. Herms, M. A., *Head of Div. and Parasitol.*

*†E. R. de Ong, B. S., *Instr. Ent.*

Entomology—Continued.

*†E. O. Essig, M. S., *Assoc. Prof. Ent.*

*†S. B. Freeborn, B. S., *Asst. Prof. Ent.*

†Hugh Knight, *Asst. in Ent. (P. O., Riverside)*

*†H. J. Quayle, M. S., *Prof. Ent. (P. O., Riverside).*

*†H. H. P. Severin, Ph. D., *Instr. Ent.*

†H. S. Smith, M. A., *Assoc. Prof. Ent. (P. O., Riverside).*

*†T. I. Storer, M. S., *Asst. Prof. Zool. (P. O., Davis).*

*†E. C. Van Dyke, M. D., *Asst. Prof. Ent.*

*†G. H. Vansell, A. M., *Instr. Ent. (P. O., Davis).*

*†C. W. Woodworth, M. S., *Prof. Ent.*

Extension (Admin.): † Director Crocheron in charge.

—————, *County Agt. Leader.*

†Harriet G. Eddy, A. B., *State Home Dem. Leader.*

—————, *State Club Leader.*

†Lillian D. Clark, *Asst. State Home Dem. Leader.*

—————, *Asst. State Leader, Coast Counties.*

†W. R. Ralston, B. S., *Asst. State Club Leader.*

†C. W. Rubel, B. S., *Asst. State Leader Northern Counties.*

†May Secrest, B. S., *Asst. State Home Dem. Leader.*

†L. B. Smith, B. S., *Asst. State Leader, Southern Counties.*

†F. M. Spurrier, B. S., *Asst. State Club Leader, Northern Counties.*

†J. E. Tippet, B. S., *Asst. County Agt. Leader.*

†W. G. Waterhouse, B. S., *Asst. State Club Leader, Coast Counties.*

†V. C. Bryant, M. S., *County Organ. Work.*

†T. Fr. Hunt, B. S., *Organized Counties Specialist.*

†Wm. J. Norton, Ph. C., *Visual Instruction.*

Forestry: *†Walter Mulford, F. E., *Head of Div.*

*†Donald Bruce, M. F., *Assoc. Prof. For.*

*†Emanuel Fritz, M. F., *Asst. Prof. For.*

*†Woodbridge Metcalf, M. S., *Assoc. Prof. For.*

*†A. W. Sampson, Ph. D., *Assoc. Prof. For.*

†F. X. Schumacher, B. S., *Asst. in For.*

Genetics: *†E. B. Babcock, M. S., *Head of Div.*

*R. E. Clausen, Ph. D., *Asst. Prof. Genetics.*

*†J. L. Collins, Ph. D., *Instr. Genetics.*

†J. W. Lesley, M. A., *Asst. in Genetics (P. O., Riverside.)*

*†Margaret C. Mann, Ph. D., *Asst. in Genetics; Cytologist.*

Home Economics: *Agnes F. Morgan, Ph. D., *Chair. Dept. of Household Sci.*

*Mary F. Patterson, *Chair. Dept. of Household Art.*

†Jessie L. Decker, *Home Furnishing Specialist.*

†Ethelyn M. Dodson, B. S., *Clothing Specialist.*

*W. E. Bates, M. D., *Lect. in Hyg. (P. O., Davis).*

Horticulture: Dean Webber, *Prof. Subtropical Hort.*

*†F. T. Bioletti, M. S., *Head Div. of Vit. and Fruit Products.*

† For subject-matter workers see the respective division, i. e., agronomy, animal industry, etc.

Horticulture—Continued.

- *†J. W. Gregg, B. S., *Head Div. of Landsc. Gard. and Flor.*
 *†W. L. Howard, Ph. D., *Head Div. of Pomol. (P. O., Davis).*
 *†L. D. Batchelor, Ph. D., *Prof. Orchard Mgt. (P. O., Riverside).*
 *†W. H. Chandler, Ph. D., *Prof. Pomol.*
 *F. W. Allen, M. S., *Asst. Prof. Pomol. (P. O., Davis).*
 *†C. L. Austin, B. S., *Asst. in Pomol. (P. O., Davis).*
 †J. P. Bennett, Ph. D., *Asst. Prof. Pomol.*
 †Leon Bonnet, I. A., *Assoc. in Vit. (P. O., Davis).*
 *†A. W. Christie, M. S., *Asst. Prof. Fruit Products.*
 *†W. V. Cruess, B. S., *Assoc. Prof. Fruit Products.*
 *†L. H. Day, *Assoc. in Pomol. (P. O., Davis).*
 †W. P. Duruz, M. S., *Instr. Pomol. (P. O., Davis).*
 *†C. L. Flint, B. S., *Instr. Landsc. Gard. and Flor.*
 *†H. B. Frost, Ph. D., *Research Assoc. in Plant Brdg. (P. O., Riverside).*
 †Charles Hartman, jr., *Asst. in Orchard Mgt. (P. O., Riverside).*
 *†A. H. Hendrickson, B. S., *Asst. Prof. Pomol. (P. O., Mountain View).*
 †M. J. Heppner, M. S., *Asst. in Pomol. (P. O., Davis).*
 †W. B. Hooper, B. S., *Specialist in Walnut Growing.*
 †J. H. Irish, M. S., *Assoc. in Fruit Products.*
 †H. E. Jacob, M. S., *Asst. in Vit. and Fruit Products (P. O., Davis).*
 †J. C. Johnston, B. S., *Instr. Citriculture.*
 *†H. A. Jones, Ph. D., *Assoc. Prof. Oler. (P. O., Davis).*
 *†Katherine D. Jones, B. S., *Instr. Landsc. Gard. and Flor.*
 *†E. L. Overholser, M. A., *Asst. Prof. and Asst. Pomol.*
 *†G. L. Philp, M. S., *Asst. Prof. Pomol. (P. O., Davis).*
 *†E. L. Proebsting, M. S., *Instr. Pomol. (P. O., Davis).*

Horticulture—Continued.

- *†J. T. Rosa, jr., Ph. D., *Asst. Prof. Oler. (P. O., Davis).*
 †Edna M. Russ, B. S., *Asst. in Pomol. (P. O., Davis).*
 †W. R. Schoonover, M. S., *Citriculture Specialist (P. O., Riverside).*
 *†H. W. Shepherd, B. S., *Instr. Landsc. Gard. (P. O., Davis).*
 †J. L. Stahl, B. S., *Assoc. in Pomol. (P. O., Davis).*
 †J. G. Surr, *Asst. in Orchard Mgt. (P. O., Riverside).*
 *†W. P. Tufts, M. S., *Asst. Prof. Pomol. (P. O., Davis).*
 *†A. J. Winkler, Ph. D., *Assoc. in Vit. (P. O., Davis).*

Nutrition: *†M. E. Jaffa, M. S., *Head of Div.*

- †Hilda Faust, M. A., *Nutr. Specialist*
 †Harold Goss, B. S., *Instr. Nutr.*
 *†E. J. Lea, M. S., *Assoc. Prof. Nutr.*

Plant Pathology: *†R. E. Smith, B. S., *Head of Div.*

- *†J. T. Barrett, Ph. D., *Prof. Plant Path.; Assoc. Dir. Citrus. Expt. Sta. (P. O., Riverside).*
 *†H. S. Fawcett, Ph. D., *Prof. Plant Path. (P. O., Riverside).*
 *†E. T. Bartholomew, Ph. D., *Asst. Prof. Plant Path. (P. O., Riverside).*
 *†W. T. Horne, B. S., *Assoc. Prof. Plant Path.*
 *†B. A. Rudolph, M. S., *Research Assoc. in Plant Path. (P. O., Mountain View).*
 *†C. O. Smith, M. S., *Research Assoc. in Plant Path. (P. O., Riverside).*
 *†Elizabeth H. Smith, M. S., *Asst. Prof. Plant Path.*

Veterinary Science: *†G. H. Hart, D. V. M., M. D., *Head of Div.*

- †E. H. Barger, D. V. M., *Asst. Vet. (P. O., Davis).*
 *†J. R. Beach, D. V. M., *Asst. Prof. Vet. Sci.*
 †D. E. Davis, D. V. M., *Avian Path. (P. O., Petaluma).*
 *†F. M. Hayes, D. V. M., *Assoc. Prof. Vet. Sci. (P. O., Davis).*
 *†Jacob Trauma, D. V. M., *Assoc. Prof. Vet. Sci.*

COLORADO.

The State Agricultural College of Colorado and the Agricultural Experiment Station, Fort Collins.

*College faculty. †Station staff. ‡Extension staff.

*C. A. Lory, M. S., LL. D., D. Sc., *President.*

*S. A. Johnson, M. S., *Dean.*

*†C. P. Gillette, D. Sc., *Dir. of Sta.*

‡Roud McCann, B. S., *Dir. Ext. Service.*

L. D. Crain, M. E., *Chair. Div. of Engin.*

Agromony: *†Alvin Kezer, M. A., *Prof. Agron. and Chair. Div. of Agr.; Agron.*

*C. H. Allford, B. S., *Asst. Prof. Agron.*

*†Waldo Kidder, B. S., *Agron. Specialist.*

*J. D. Marshall, B. S., *Assoc. Prof. Agron.*

†D. W. Robertson, M. S., *Assoc. Agron. (Cereal Brdg.).*

Animal Industry: *†G. E. Morton, M. L., B. S., *Head Dept. of An. Husb. (State Dairy Comr.).*

*†C. I. Bray, M. S., *Assoc. Prof. and Asst. An. Husb.*

*L. K. Crowe, B. S., *Asst. Prof. An. Husb.*

*B. W. Fairbanks, B. S., *Asst. Prof. An. Husb.*

Animal Industry—Continued.

- †D. A. Jay, *An. Husb. Specialist*.
 †R. F. Keiffer, B. S., *Asst. Prof. An. Husb.*
 †O. C. Krum, B. S., *Poultry Specialist*.
 †E. J. Maynard, M. S., *Specialist in An. Invest.*
 †C. N. Shepardson, B. S., *Asst. Prof. An. Husb.*
 *H. H. Smith, B. S., *Asst. Prof. An. Husb.*
 *O. C. Ufford, B. S., *Asst. Prof. Poultry Husb.*

Bacteriology: †W. G. Sackett, Ph. D., *Bact.*

†B. Mildred Brown, B. S., *Asst. in Bact.*

Botany: *†A. K. Peitersen, Ph. D., *Prof. Bot.*

- *†C. D. Learn, M. A., *Asst. Prof. and Asst. Bot.*
 *†Anna M. Lute, B. S., *Instr. Bot.; Seed Analyst.*
 *†E. C. McCarty, B. S., *Asst. Prof. and Asst. Bot.*

*†Caroline M. Preston, *Instr. Bot.; Artist.*

Chemistry: *†W. P. Headden, Ph. D., D. Sc., *Prof. Chem., Geol.; Chem.*

- *R. G. Coffin, B. S., *Assoc. Prof. Chem.*
 †Earl Douglass, M. S., *Asst. Chem.*
 †Beatrice J. Geiger, B. S., *Asst. Prof. Chem.*
 *G. E. Mills, B. A., *Asst. Prof. Chem.*
 †J. W. Tobiska, M. A., *Asst. Chem.*
 †C. E. Vail, M. A., *Asst. Chem.*
 *L. S. Ward, A. M., *Asst. Prof. Chem.*
 *G. H. Whiteford, Ph. D., *Prof. Chem.*
 *Elizabeth M. Wing, A. M., *Asst. Prof. Chem.*

Economics (Rural): *†L. A. Moorhouse, M. S., *Prof. Rural Econ. and Sociol.; Rural Econ.*

- *†R. T. Burdick, M. S., *Assoc. Prof. Rural Econ. and Sociol.; Asst. in Rural Econ.*
 *B. F. Coen, M. A., *Assoc. Prof. Sociol.*
 †George Knutson, B. S., *Asst. in Rural Econ.*
 †A. T. Steinel, *Rural Development Specialist.*
 †T. H. Summers, *Farm Mgt. Dem.*

Education (Rural): *C. G. Sargent, M. A., *Prof. Rural Ed., Dir. Voc. Ed.*

- *G. T. Avery, *Assoc. Prof. Ed.*
 *Margaret E. Durward, Ph. B., *Prin. School of Agr.*
 *G. A. Schmidt, M. S., *Assoc. Prof. in charge Agr. Ed.*

Engineering (Agr.): *†E. B. House, B. S. E. E., M. S., *Prof. and Irrig. Engin.*

- *†O. V. Adams, B. S., C. I. E., *Instr. Irrig. Engin.; Testing Engin.*
 †F. L. Cooper, *Agr. Engin. Specialist.*
 †R. L. Parshall, B. S., *Irrig. Invest. (Detailed by U. S. D. A.).*
 *O. P. Pennock, M. S., *Assoc. Prof. Irrig. Engin.*
 *J. W. Sjogren, B. S., *Assoc. Prof. Farm Mech.*
 †R. E. Trimble, B. S., *Asst. in Irrig. Invest.*

Entomology and Zoology: Director Gillette in charge.

- *S. A. Johnson, M. S., *Assoc. Prof. Ent. and Zool.*
 †W. L. Burnett, *Rodent Invest.*
 *†J. L. Hoerner, B. S., *Instr. Ent., Zool.; Asst. Ent.*
 *†C. R. Jones, M. S., *Assoc. Prof. Ent., Zool.; Asst. Ent.*
 *†G. M. List, B. S., *Asst. Prof. Ent., Zool.; Asst. Ent. (Chief Deputy State Ent.).*
 †J. H. Newton, B. S., *Asst. Ent. (Deputy State Ent.).*
 *†Miriam A. Palmer, M. A., *Asst. Prof. Ent., Zool.; Asst. Ent. and Insect Delineator.*

Extension (Admin.): †Director McCann in charge

- †Maude E. Sheridan, M. Pd., *State Club Leader, Organ. Specialist in Women's Work.*
 †R. H. Felts, B. S., *Asst. County Agt. Leader.*
 †W. R. Freeman, B. S., *Asst. State Club Leader.*
 †R. W. Schafer, B. S., *Asst. County Agt. Leader.*
 †E. D. Smith, *Asst. County Agt. Leader.*

Forestry: *W. J. Morrill, M. F., *Prof. For. (State For.).*

*†B. O. Longyear, B. S., *Assoc. Prof. For.; For. Invest.*

Home Economics: *Inga M. K. Allison, E. B., *Head of Dept.*

- *Mary C. Blodgett, B. S., *Asst. Prof. Home Econ.*
 *Charlotte E. Carpenter, Ph. B., *Assoc. Prof. Home Econ.*
 *Beryl Dixon, B. S., *Asst. Prof. Dom. Art.*
 *†Nellie E. Goldthwaite, Ph. D., *Assoc. Prof. Home Econ.; Home Econ. Invest.*
 †Mrs. Blanche E. Hyde, *Clothing Specialist.*
 *Juliet L. Jewett, B. S., *Instr. Home Econ.*
 *Grace Linder, A. M., *Assoc. Prof. Home Econ.*
 *Bertha R. Most, *Assoc. Prof. Home Econ.*
 †Eva F. Smith, B. S., *Asst. Home Econ. Specialist.*
 †Kittie D. Washington, *Nutr. Specialist.*

Horticulture: *†E. P. Sandsten, Ph. D., *Prof. Hort.; Hort. (State Hort.).*

- *†F. M. Green, B. S., *Asst. Hort. (Chief Deputy State Hort.: P. O., Delta).*
 *E. M. Lowry, M. S., *Assoc. Prof. Hort.*
 †R. A. McGinty, A. M., *Assoc. Prof. and Assoc. Hort.*
 †R. C. Thompson, B. S., *Asst. Hort.*
 †C. M. Tompkins, B. S., *Asst. Hort.*
 *Edgar Tubby, *Florist.*

Physics: *F. G. Person, A. M., *Head of Dept.*

- *F. P. Goeder, M. S., *Assoc. Prof. Phys.*
 *D. W. Richardson, B. S., *Asst. Prof. Phys.*

Veterinary Science: *†G. H. Glover, M. S., D. V. M., *Head Div. of Vet. Med.*

- *R. F. Bourne, B. S., D. V. S., *Prof. Vet. Physiol.*
 †Floyd Cross, D. V. M., *Asst. Vet. Path.*
 *James Farquharson, D. V. M., *Asst. Prof. Vet. Anat.*
 *†W. H. Feldman, D. V. M., *Asst. Prof. and Asst. in Vet. Path.*
 *H. E. Kingman, B. S., D. V. S., *Prof. Vet. Surg.*
 *†I. E. Newsom, B. S., D. V. S., *Prof. Vet. Path.; Vet. Path.*

Miscellaneous:

- *Charlotte A. Baker, *Libr.*
 *††G. C. Eddy, *Photog.*
 *††I. G. Kinghorn, *Pub. Editor.*

Substations:

- Ark. Valley Substa., P. O., *Rocky Ford*—P. K. Blinn, B. S., *Alfalfa Invest.*
 Cheyenne Wells Substa., P. O., *Cheyenne Wells*—J. W. Adams, B. S., *Asst. in Agron. and Dry Farming.*
 Fort Lewis Substa., P. O., *Hesperus*—J. W. Curtiss, B. S., *Asst. in High Altitude Hort.*
 H. D. Horton, B. S., *Asst. in High Altitude Agron.*

¹ For subject-matter workers see the respective division, i. e., agronomy, animal industry, etc.

CONNECTICUT.

Connecticut Agricultural College and the Storrs Agricultural Experiment Station, Storrs (telephone address, Storrs via *Willimantic*; railroad station and express address, *Willimantic*).

*College faculty. †Station staff. ‡Extension staff.

*C. L. Beach, B. Agr., B. S., *President*.

†W. L. Slate, jr., B. S., *Dir. of Sta.*

‡B. W. Ellis, B. S., *Dir. Ext. Service*.

Agronomy: Director Slate, *Sta. Agron.*

*†Henry Dorsey, M. S., *Asst. Prof. and Asst. Agron.*

†B. A. Brown, *Asst. Agron.*

‡J. S. Owens, M. S., *Soil and Crop Specialist*.

Animal Industry: *H. L. Garrigus, B. Agr., *Prof. An. Husb.*

*†W. F. Kirkpatrick, B. E., B. Agr., *Prof. Poultry Husb.: Poultry Husb.*

†L. F. Rettger, Ph. D., *Bact. in An. Diseases (P. O., Yale Sta.)*.

*†G. C. White, M. A., *Prof. Dairy Husb.: Dairy Husb.*

†R. E. Begg, B. S., *Sheep Specialist*.

†L. C. Dunn, Sc. D., *Geneticist (Poultry Work)*.

*†R. C. Fisher, B. S., *Asst. Prof. and Asst. in Dairy Mfg.*

‡R. E. Jones, *Poultry Specialist*.

†J. G. McAlpine, M. A., *Asst. Bact. in An. Diseases*.

†A. R. Merrill, B. S., *Dairy Specialist*.

†J. A. Simms, B. S., *An. Husb. Specialist*.

*A. G. Skinner, B. S., *Asst. Prof. An. Husb.*

†J. C. Taylor, B. S., *Poultry Specialist*.

*D. E. Warner, jr., B. S., *Asst. Prof. Poultry Husb.*

Bacteriology: *W. M. Esten, M. S., *Prof. Bact.*

*Miss C. J. Mason, B. Agr., *Instr. Bact.*

Botany: *E. W. Sinnott, Ph. D., *Prof. Bot. and Genetics, Dean Div. of Agr. Sci.*

*G. S. Torrey, A. M., *Asst. Prof. Plant Path.*

Chemistry: *H. D. Newton, Ph. D., *Prof. Chem.*

†H. J. Fisher, B. A., *Chem. (P. O., New Haven)*.

*J. L. Hughes, A. M., *Asst. Prof. Chem.*

Economics (Agr.): *†I. G. Davis, B. A., *Prof. Agr. Econ., Economist*.

*†A. W. Manchester, B. Agr., *Prof. Farm Mgt., Farm Mgt. Dem.*

*E. H. Gumbart, Ph. D., *Asst. Prof. Econ.*

*†C. I. Hendrickson, M. S., *Asst. Prof. and Asst. in Agr. Econ.*

†Paul Mehl, M. A., *Marketing Specialist*.

†P. L. Putnam, B. S., *Asst. Farm Mgt. Dem.*

Education (Agr.): *C. B. Gentry, B. S., *Prof. Agr. Ed. and Dean of Teacher Training*.

*J. L. Hypes, A. M., *Assoc. Prof. Ed.*

Engineering (Agr.): *†F. W. Knipe, B. S., *Instr. Agr. Engin., Specialist in Farm and Home Engin.*

Extension (Admin.):¹ Director Ellis in charge.

†M. Estella Sprague, *State Home Dem. Lectr.*

†A. J. Brundage, *State Club Leader*.

†Mary V. Hall, *Asst. State Club Leader*.

†Elsie Trabue, *Asst. State Club Leader*.

Forestry: *A. E. Moss, M. F., *Instr. For.*

Home Economics: *M. Estella Sprague, *Dean of Div.*

†Mildred C. Annan, *Millinery Specialist*.

†Dorothy S. Buckley, Ph. B., *Nutr. Specialist*.

†Marion E. Dakin, *Nutr. Specialist*.

*Ellen Edmonson, B. A., *Instr. Home Econ.*

*Marie G. Lundberg, B. S., *Instr. Home Econ.*

†Lizbeth MacDonald, R. N., *Home Nursing Specialist*.

†Edith L. Mason, B. S., *Clothing Specialist*.

*Ella J. Rose, B. S., *Instr. Home Econ.*

*Gladys I. Sharfenstein, B. S., *Instr. Home Econ.*

Horticulture: *S. P. Hollister, B. S., *Prof. Hort.*

†W. H. Darrow, M. S., *Fruit Specialist*.

*R. H. Patch, M. S., *Asst. Prof. Flor.*

*A. T. Stevens, M. S., *Asst. Prof. Veg. Gard.*

†A. E. Wilkinson, M. S., *Veg. Gard. Specialist*.

Veterinary Science: *B. K. Dow, V. S., *Lect. in Vet. Sci.*

Zoology: *†G. H. Lamson, jr., M. S., *Prof. Zool.; Zool.*

*J. A. Manter, B. S., *Instr. Ent.*

*†L. B. Crandall, B. S., *Prof. Apiculture, Bee Specialist*.

Miscellaneous:

*R. E. Dodge, M. A., *Dean Two-Year Course in Agr.*

†R. H. Mathewson, B. S., *Asst. to Editor*

†Walter Stemmons, B. S., *Pub. Editor*.

*Edwina M. Whitney, Ph. B., *Libr.*

¹ For subject-matter workers see the respective division, i. e., agronomy, animal industry, etc.

Connecticut State Agricultural Experiment Station, *New Haven.*

†Station staff.

†E. H. Jenkins, Ph. D., *Director Emeritus.*†W. L. Slate, Jr., B. S., *Director.***Analytical Chemistry:** †E. M. Bailey, Ph. D.,
Chem. in charge.†R. E. Andrew, M. A., *Asst. Chem.*†H. J. Fisher, B. A., *Asst. Chem.*†O. L. Nolan, *Asst. Chem.*†C. E. Shepard, *Asst. Chem.***Biochemistry:** †T. B. Osborne, Ph. D., D. Sc.,
Chief Research Chem. in charge.†C. S. Leavenworth, Ph. B., *Asst. Chem.*†H. B. Vickery, Ph. D., *Asst. Chem.*†A. J. Wakeman, Ph. D., *Asst. Chem.***Botany:** †G. P. Clinton, Sc. D., *Bot. in charge.*†Florence A. McCormick, Ph. D., *Path.*†E. M. Stoddard, B. S., *Pomol.***Entomology:** †W. E. Britton, Ph. D., *Ent. in charge (State Ent.).*†J. T. Ashworth, *Deputy in charge Gipsy Moth Work.***Entomology**—Continued.†R. C. Botsford, *Deputy in charge Mosquito Elimination.*†R. B. Friend, B. S., *Asst. Ent.*†Philip Garman, Ph. D., *Asst. Ent.*†B. H. Walden, B. Agr., *Asst. Ent.*†M. P. Zappe, B. S., *Asst. Ent.***Forestry:** †W. O. Filley, *Forester in charge.*†H. W. Hicock, M. F., *Asst. For.*†A. E. Moss, M. F., *Asst. For. (P. O., Storrs).***Genetics:** †D. F. Jones, S. D., *Plant Breeder in charge.*†P. C. Mangelsdorf, M. S., *Asst. in Plant Brdg.***Soils:** †M. F. Morgan, M. S., *Invest. in Soils.***Miscellaneous:**Miss L. M. Brautlecht, *Libr.***Substations:**Tobacco Substa., *P. O., Windsor*—C. M. Slagg, M. S., *in charge.*

DELAWARE.

School of Agriculture and the Agricultural Experiment Station of the University of Delaware,
Newark.

*College faculty. †Station staff. ‡Extension staff.

*Walter Hulihan, Ph. D., *President of University.**†C. A. McCue, B. S., *Dean School of Agr., Dir. of Sta., Dir. of Ext. Service.*M. Van G. Smith, M. E., *Actg. Dean School of Engin.***Agronomy:** *†G. L. Schuster, M. S., *Prof. Agron.; Agron.**†C. R. Runk, M. S., *Asst. Prof. and Assoc. Agron.*†M. A. Willis, B. S., *Asst. Agron.***Animal Industry:** *†C. C. Palmer, D. V. M.,
M. S., *Prof. An. Indus., Bact.; Consult. Vet.**†T. A. Baker, B. S., *Prof. An. Husb.; An. Husb.**†H. R. Baker, B. S., *Instr. An. Indus.; Research Asst. in Poultry Diseases.**†A. E. Tomhave, M. S., *Instr. An. Husb.; Asst. in Swine Invest.***Chemistry:** †L. W. Tarr, B. S., *Chem.*†G. L. Baker, B. S., *Asst. Chem.***Education (Agr.):** *R. W. Heim, M. S., *Prof. Voc. Agr. Ed.***Extension (Admin.):**¹ Director McCue *in charge.*†M. O. Pence, B. S., *County Agt. Leader and Farm Mgt. Dem.*†Kathryn E. Woods, *State Home Dem. Leader.*†A. D. Cobb, B. S., *State Club Leader.***Home Economics:**² *Laura V. Clark, A. B.,
*Prof. Home Econ.**Katherine Gumble, B. S., *Instr. Home Econ.**Elizabeth Kelly, A. M., *Instr. Home Econ.***Horticulture:** Dean and Dir. McCue, *Head of Dept.**†L. R. Detjen, M. S., *Assoc. Prof. and Assoc. Hort.**†G. F. Gray, M. S., *Instr. and Asst. Hort.***Plant Pathology:** *††T. F. Manns, Ph. D.,
Prof. Plant Path. and Soil Bact., Plant Path. and Soil Bact.††J. F. Adams, Ph. D., *Assoc. Plant Path. and Specialist in Plant Path.***Plant Physiology:** †E. M. R. Lamkey, Ph. D.,
*Plant Physiol. and Soil Bact.***Miscellaneous:***††Florence Colbert, *Secy.*†Freda Ritz, *Libr.*State College for Colored Students, *Dover.*

*Agricultural faculty.

*R. S. Grossley, B. S., *President.**J. B. Aiken, *Instr. Practical Agr.**Florence G. Brooks, *Instr. Home Econ.**Helen B. Grossley, *Dir. Home Econ.**W. W. Lawson, *Instr. Voc. Agr.**Helen L. Yancey, *Libr.*¹ For subject-matter workers see the respective division, i. e., agronomy, animal industry, etc.² Given in the Women's College.

FLORIDA.

College of Agriculture and the Agricultural Experiment Station of the University of Florida,
Gainesville.

*College faculty. †Station staff. ‡Extension staff.

*A. A. Murphree, A. M., LL. D., *President of University.*

*†Wilmon Newell, M. S., D. Sc., *Dean Coll. of Agr., Dir. of Sta., Dir. of Ext. Div.*
J. R. Benton, Ph. D., *Dean Coll. of Engin.*

Agriculture: †E. L. Ayers, B. S., *Agr.*

Agronomy: *J. E. Turlington, Ph. D., *Prof. Agron.*

*O. C. Bryan, Ph. D., *Asst. Prof. Agron.*

*H. G. Hamilton, M. S., *Farm Mgt. Field Work.*

†W. E. Stokes, M. S., *Asst. Grass and Forage Crop Investigator.*

Animal Industry: ††J. M. Scott, B. S., *An. Indus. and Vice Dir. of Sta.*

*C. H. Willoughby, B. Agr., *Prof. An. Husb. and Dairying.*

*N. W. Sanborn, M. D., *Prof. Poultry Husb.*

†H. L. Brown, M. S., *Ext. Dairyman.*

†H. B. Lansden, *Poultry Specialist.*

Chemistry: †R. W. Ruprecht, Ph. D., *Chem.*

†C. E. Bell, B. S., *Asst. Chem.*

*A. P. Black, A. B., *Assoc. Prof. Agr. Chem.*

†J. M. Coleman, B. S., *Asst. Chem.*

Education (Agr.): *J. W. Day, A. M., *Prof. Agr. Ed.*

Engineering (Agr.): *Frazier Rogers, B. S., *Prof. Agr. Engin.*

*A. J. Strong, *Asst. Prof. Agr. Engin.*

Entomology: †J. R. Watson, M. A., *Ent.*

†A. H. Beyer, M. S., *Asst. Ent.*

Extension (Admin.): † Director Newell in charge.

†A. P. Spencer, M. S., *Vice Dir.*

†Flavia Gleason, *State Home Dem. Agt. (P. O., Tallahassee).*

†R. W. Blacklock, A. B., *State Club Leader.*

†Virginia P. Moore, *Asst. State Home Dem. Agt. (P. O., Tallahassee).*

Horticulture and Botany: *W. L. Floyd, M. S., *Prof. Hort., Bot., Asst. Dean Coll. of Agr.*

*C. E. Abbott, B. S., *Instr. Hort.*

†G. H. Blackmon, B. S., *Pecan Culturist.*

*E. L. Lord, B. S., *Asst. Prof. Hort. and Bot.*

†Harold Mowry, *Asst. Hort.*

*J. S. Rogers, A. M., *Prof. Biol. (Agr.).*

*Frank Thone, Ph. D., *Asst. Prof. Bot. and Bact. (Agr.).*

Journalism: *††Ralph Stoutamire, B. S., *Prof. Agr. Journalism. Editor.*

Plant Pathology: †O. F. Burger, Sc. D., *Plant Path.*

†E. F. DeBusk, B. S., *Ext. Citrus Path.*

†L. O. Gratz, Ph. D., *Asst. Plant Path. (P. O., Hastings).*

*John Gray, M. S., *Asst. Prof. Plant Path. and Econ. Ent.*

†A. S. Rhoads, Ph. D., *Asst. Plant Path. (P. O., Cocoa).*

†J. R. Springer, B. S., *Ext. Plant Path. and Ent.*

†G. F. Weber, Ph. D., *Assoc. Plant Path.*

Veterinary Science: *A. L. Shealy, B. S.,
D. V. M., *Prof. Vet. Sci.*

Miscellaneous:

†Mrs. Ida K. Cresap, *Libr.*

*††K. H. Graham, *Auditor.*

*Cora Miltimore, B. S., *Libr.*

Substations:

Citrus Expt. Sta., *P. O. Lake Alfred—J. H. Jefferies, Supt.*

Tobacco Expt. Sta., *P. O., Quincy—*

W. B. Tisdale, Ph. D., *Assoc. Plant. Path.*

J. G. Kelly, B. S., *Lab. Asst.*

Florida Agricultural and Mechanical College for Negroes, Tallahassee.

*Agricultural faculty. ‡Extension staff.

*W. H. A. Howard, B. S., A. M., *President.*

*A. L. Mebane, M. S. A., *Dean Dept. of Agr.*

*J. D. Bryan, *An. Husb.*

*Irma Coleman, *Instr. Dom. Sci.*

*B. H. Crutcher, B. S. A., *Dairying, Agr.*

*R. A. Edmondson, A. B., *Prof. Phys.*

*H. M. Efferson, A. B., *Asst. Prof. Sci.*

*Richard Frazier, *Hort.*

*Gertrude Hayes, *Instr. Nurse Training.*

*Virginia Hilyer, R. N., *Supt. Nurse Training School.*

*E. B. Jones, B. S., *Prof. Biol., Chem.*

*Lillian Latimer, *Dom. Sci.*

*Clara B. Moon, *Instr. Dom. Art.*

*Clementina Nelson, B. S., *Prof. Dom. Sci.,
Dean Dept. of Home Econ.*

*Ellen O. Paige, *Instr. Dom. Art.*

*Alma H. Rivers, *Libr.*

†A. A. Turner, *Farmers' Club Organizer.*

† For subject-matter workers see the respective division, i. e., agriculture, agronomy, etc.

GEORGIA.

Georgia State College of Agriculture, University of Georgia, *Athens*.

*College faculty. †Extension staff.

*A. M. Soule, Sc. D., F. R. S. A., LL. D., *President*.†J. Phil. Campbell, B. S., *Dir. of Ext. Div.*C. M. Strahan, C. and M. E., Sc. D., *Engineering (Univ. of Ga.)*.**Agronomy:** *†J. R. Fain, D. Sc., *Prof. Agron.**G. A. Crabb, B. S., *Prof. Agron. in charge Soil Work.**R. R. Childs, M. S., *Prof. Agron. in charge Cotton Indus. (Coop. U. S. D. A.)*.*E. D. Alexander, B. S., *Assoc. Prof. Agron.*†H. C. Appleton, B. S., *Field Crop Specialist.**D. W. Brooks, B. S., *Adjunct Prof. Agron.*†L. V. Davis, B. S., *Supvr. Fert. Invest.**J. M. Elrod, B. S., *Assoc. Prof. Agron.*†Paul Tabor, M. S., *Field Crop Specialist.**P. O. Vanatter, *Supt. Field Expts.*†F. C. Ward, B. S., *Cotton Specialist.***Animal Industry:** *†M. P. Jarnagin, D. Sc., *Prof. An. Husb.**†J. H. Wood, B. S., *Prof. Poultry Husb.**F. W. Bennett, B. S., *Assoc. Prof. Dairy Husb.*†F. W. Fitch, B. S., *Field Agt. in Dairy Husb.**A. F. Gannon, B. S., *Instr. Poultry Husb.**C. E. Kellogg, M. S., *Assoc. Prof. An. Husb.*†J. G. Liddell, B. S., *Swine Specialist.*†W. C. McCoy, B. S., *Field Agt. in Poultry Husb.*†L. H. Marlatt, *Field Agt. in Cheese Prod. (Coop. U. S. D. A.)*.*W. S. Rice, B. S., *Adjunct Prof. An. Husb.**G. P. Saye, B. S., *Assoc. Prof. An. Husb.**R. S. Wooster, B. S., *Assoc. Prof. Poultry Husb.***Botany:** *J. M. Reade, Ph. D., *Prof. Bot.***Chemistry:** *L. M. Carter, B. S., *Prof. Soil Chem.*†W. O. Collins, B. S., *Assoc. Prof. Soil Chem.*†M. W. Lowry, M. A., *Assoc. Prof. Soil Chem.*†S. W. Phillips, M. S., *Soil Survey Expert.**R. M. Soule, B. S., *Assoc. Prof. Agr. Chem.**H. C. White, Ph. D., Sc. D., *Prof. Chem.**C. N. Wilder, M. S., *Assoc. Prof. Agr. Chem.**R. C. Wilson, Ph. G., *Prof. Pharm. and Materia Medica.***Economics (Agr.):** †M. C. Gay, *Market Specialist.*†DeForest Hungerford, M. A., *Sci. Asst. in Farm Mgt. (Coop. U. S. D. A.)*.†E. C. Westbrook, B. S., *Farm Mgt. Specialist.***Education (Agr.):** *J. T. Wheeler, B. S., *Prof. Agr. Ed.**W. W. Reitz, M. S., *Prof. Agr. Ed.**Epsie Campbell, B. S., *Supvr. Voc. Ed.**F. C. Chandler, B. S., *in charge Practice School.**P. W. Chapman, B. S., *State Supvr. Voc. Agr. Ed.**L. M. Sheffer, B. S., *Assoc. Prof. Agr. Ed.***Engineering (Agr.):** *W. A. Foster, Arch. E., *Prof. Agr. Engin.*†W. E. Broach, B. S., *Field Agt. in Agr. Engin.**W. A. Clegg, B. S., *Assoc. Prof. Agr. Engin.**L. E. Fitch, B. S., *Adjunct Prof. Agr. Engin.**W. G. Wingate, B. S., *Instr. Agr. Engin.***Extension (Admin.):** †Director Campbell in charge.†J. K. Giles, B. S., *Asst. Dir.*†J. G. Oliver, B. S., *State Agt.*†Frances E. Colclough, *State Home Dem. Agt.*†G. V. Cunningham, B. S., *State Club Agt.*†Lois P. Dowdle, B. S., *State Club Agt.*†William Bradford, A. B., M. D., *Asst. State Club Agt.***Forestry:** *T. D. Burleigh, M. S., *Assoc. Prof. For.**DuPre Barrett, B. S., *Adjunct Prof. For.**L. R. Smith, B. S., *Adjunct Prof. For.***Home Economics:** *†Mary E. Creswell, B. S., *Dir. of Home Econ.**Susie Burson, B. S., *Instr. Home Econ.**Edith V. Creswell, B. S., *Instr. Home Econ.*†Susan Mathews, *Nutr. Specialist.**Erna E. Proctor, B. S., *Assoc. Prof. Foods and Cookery.**Rosalie V. Rathbone, B. S., *Assoc. Prof. Textiles and Clothing.**Rhea C. Scott, B. S., *Assoc. Prof. Institutional Econ.*†Frances Simpson, B. S., *Nutr. Specialist.***Horticulture:** *†T. H. McHatton, D. Sc., M. H., *Prof. Hort.*†G. H. Firor, B. S., *Field Agt. in Hort.**H. L. Harrington, B. S., *Adjunct Prof. Hort.*†H. W. Harvey, B. S., *Landsc. Gard. Specialist.**J. W. Howard, B. S., *Instr. Hort.**R. L. Keener, B. S., *Adjunct Prof. Hort.*†H. M. McKay, B. S., *Field Agt. in Hort.***Veterinary Medicine:** *A. G. G. Richardson, V. M. D., *Prof. Vet. Med.**W. C. Burkhart, D. V. M., *Assoc. Prof. Vet. Med.**I. P. Coulter, D. V. M., *Instr. Vet. Med.**R. W. Jones, D. V. M., *Assoc. Prof. Vet. Med.**Thurston Levie, D. V. M., *Instr. Vet. Med.**H. V. Persells, D. V. M., *Assoc. Prof. Vet. Med.**J. E. Severin, D. V. M., *Assoc. Prof. Vet. Med.***Miscellaneous:**†Laura E. Blackshear, *Illustrator.**Nelle M. Reese, *Libr.**†C. W. Summerour, B. S., *Editor.*

† For subject-matter workers see the respective division, i. e., agronomy, animal industry, etc.

Georgia Experiment Station, Experiment (telegraph and express address, Griffin).

Department of Georgia State College of Agriculture at Athens.

†Station staff.

†H. P. Stuckey, B. S., *Director. Hort.*

†R. P. Bledsoe, M. S., *Agron.*

†F. H. Smith, B. S., *Chem.*

†B. B. Higgins, Ph. D., *Bot., Plant Path.*

†D. G. Sullins, M. A., *An. Husb.*

†W. A. Morgan, B. S., *Asst. Chem.*

†J. G. Woodroof, B. S., *Asst. Hort.*

Georgia Coastal Plain Experiment Station, Tifton.

†Station staff.

†S. H. Starr, B. S., *Director.*

†Fred Bell, *Farm Supt.*

†J. C. Hart, B. S., *Tobacco Specialist (Coop. U. S. D. A.).*

†W. J. Davis, B. S., *Agron.*

†Otis Woodard, B. S., *Hort.*

Georgia State Industrial College for Colored Youths, University of Georgia, Savannah.

*Agricultural faculty. †Extension staff.

*C. G. Wiley, A. M., *President.*

*J. W. Derrick, *Farm Supt.*

†A. Tabor, *Instr. Teacher Training.*

*J. S. Frazier, *Instr. Dairying and Poultry Raising.*

†Camilla Weams, *State Home Dem. Agt.*

*H. E. Hall, *Instr. Voc. Agr.*

*Mrs. W. P. White, *Instr. Sewing.*

*Howard Jackson, *Instr. Laundering.*

†E. A. Williams, *State Agent.*

†P. H. Stone, *Asst. State Agt.*

*Mrs. Mamie Williams, *Instr. Dom. Sci.*

GUAM.

Agricultural Experiment Station, Guam, Island of Guam.

Under the supervision of the Office of Experiment Stations, United States Department of Agriculture

†Station staff.

†C. W. Edwards, B. S., *Animal Husbandman in charge.*

†F. B. L. Guerrero, *Asst. in Poultry Husb.*

†Peter Nelson, *Assistant.*

†Joaquin Guerrero, *Asst. in Hort.*

HAWAII.

University of Hawaii (Divisions of Agriculture and Home Economics), Honolulu.

*College faculty.

*A. L. Dean, Ph. D., *President of University.*

*H. F. Bergman, Ph. D., *Prof. Bot.*

*Fannie E. Kerns, *Instr. Household Art.*

*Minnie E. Chipman, *Prof. Household Art.*

*Paul Kirkpatrick, Ph. D., *Prof. Phys.*

*†D. L. Crawford, M. A., *Prof. Ent. and Dir. of Ext. Service.*

*H. D. Kirschman, M. S., *Instr. Chem.*

*Anna von B. Dahl, *Asst. Prof. Textiles.*

*F. G. Krauss, D. Sc., *Prof. Agron. and Genetics.*

*F. T. Dillingham, M. A., *Prof. Chem.*

*W. R. McAllep, *Lect. on Sugar Tech.*

*C. H. Edmondson, Ph. D., *Prof. Zool. and Dir. Marine Biol. Lab.*

*Carey Miller, M. S., *Prof. Household Sci.*

*Giichi Fujimoto, M. S., *Instr. Chem.*

*J. M. Ostergaard, *Asst. in Zool.*

*Alice E. Harbaugh, *Instr. Household Art.*

*Robert Pahau, B. S., *Supt. Waiakea Farm, P. O., Hilo.*

*Clara F. Hemenway, *Libr.*

*H. S. Palmer, Ph. D., *Prof. Geol.*

*L. A. Henke, M. S., *Head of Agr. Dept.*

*Richard Wrenshall, Ph. D., *Prof. Chem.*

*A. R. Keller, C. E., M. S., *Dean Coll. of Applied Sci.*

Agricultural Experiment Station, Honolulu.

Under the supervision of the Office of Experiment Stations, United States Department of Agriculture.

†Station staff. ‡Extension work.

†J. M. Westgate, M. S., *Agronomist in charge.*

- | | |
|---|--|
| †T. L. Chung, M. S., <i>Specialist in Tropical Agron.</i> | ‡Mabel Greene, <i>Ext. Agt. in Boys' and Girls' Club Work.</i> |
| †R. A. Goff, B. S., <i>Supt. Glenwood Substa. and Ext. Agt. for Island of Hawaii (P. O., Hilo).</i> | †W. T. Pope, M. S., <i>Hort.</i> |
| | †J. C. Ripperton, M. S., <i>Chem.</i> |

Experiment Station, Hawaiian Sugar Planters' Association, Honolulu.

†Station staff.

†H. P. Agee, B. S., *Director.*

- | | |
|--|---|
| †F. W. Broadbent, <i>Asst. Agr.</i> | †O. C. Markwell, M. S., <i>Asst. Agr.</i> |
| †A. Brodie, M. A. S., <i>Tech. Chem.</i> | †J. P. Martin, B. S., <i>Asst. Plant Path.</i> |
| †L. W. Bryan, B. S., <i>For. Supvr. (Hilo Project).</i> | †F. Muir, <i>Ent.</i> |
| †H. A. Cook, A. B., <i>Asst. Chem.</i> | †H. T. Osborn, M. A., <i>Asst. Ent.</i> |
| †C. L. Crutchfield, <i>Asst. Chem.</i> | †F. A. Paris, A. E., <i>Asst. Agr.</i> |
| †Donald Forbes, <i>Supt. Vineyard Street Nursery.</i> | †C. E. Pemberton, <i>Asst. Ent.</i> |
| †Fred Hansson, Ph. B., <i>Asst. Chem.</i> | †R. C. L. Perkins, D. Sc., <i>Consult. Ent.</i> |
| †W. C. Jennings, <i>Asst. Agr.</i> | †J. S. B. Pratt, jr., M. S., <i>Assoc. Agr.</i> |
| †R. H. King, B. S., <i>Asst. Chem.</i> | †W. E. Smith, <i>Asst. Chem.</i> |
| †Y. Kutsunai, B. S., <i>Asst. Agr.</i> | †H. K. Stender, B. S., <i>Asst. Agr.</i> |
| †H. A. Lee, <i>Plant Path.</i> | †G. R. Stewart, B. S., <i>Chem.</i> |
| †H. L. Lyon, Ph. D., <i>in charge Dept. of Bot. and For.</i> | †O. H. Swezey, M. S., <i>Ent.</i> |
| †W. R. McAllep, <i>Sugar Tech.</i> | †E. C. Thomas, M. S., <i>Asst. Chem.</i> |
| †W. L. McCleery, <i>Asst. Sugar Tech.</i> | †P. H. Timberlake, A. M., <i>Asst. Ent.</i> |
| †G. A. McDoldowney, <i>For. Supvr. (Oahu Project).</i> | †F. R. Van Brocklin, B. Ch., <i>Asst. Chem.</i> |
| †W. T. McGeorge, M. S., <i>Assoc. Chem.</i> | †J. A. Verret, B. S., <i>Agr.</i> |
| | †Neil Webster, <i>Asst. Agr.</i> |
| | †F. X. Williams, Sc. D., <i>Asst. Ent.</i> |

IDAHO.

College of Agriculture and the Agricultural Experiment Station of the University of Idaho, Moscow.

*College faculty. †Station staff. ‡Extension staff.

*A. H. Upham, Ph. D., *President of University.*

*†E. J. Iddings, M. S., *Dean Coll. of Agr., Dir. of Sta., Actg. Dir. of Ext. Div.*

I. C. Crawford, C. E., *Dean Coll. of Engin.*

Agronomy: *†H. W. Hulbert, M. S., *Prof. Agron.; Agron.*

††C. B. Ahlson, B. S., *Field Agron. and Seed Comr. (P. O., Boise).*

††Jessie C. Ayres, A. B., *State Seed Analyst (P. O., Boise).*

*†F. L. Burkart, *Field Supt., Dept. of Agron.*

*†G. R. McDole, M. A., *Assoc. Prof. Agron.; Soil Tch.*

†R. L. Spangler, B. S., *Field Asst. in Agron. (P. O., Boise).*

Animal Industry: *†C. W. Hickman, B. S., *Prof. An. Husb.; An. Husb.*

*†F. W. Atkeson, B. S., *Prof. Dairy Husb.; Dairy Husb.*

*†R. T. Parkhurst, B. S., *Assoc. Prof. Poultry Husb.; Poultry Husb.*

*†G. C. Anderson, B. S., *Instr. and Asst. in Dairy Husb.*

*†H. A. Bendixen, M. S., *Asst. Prof. and Asst. Dairy Husb.*

†Pren Moore, *Poultry Specialist (P. O., Boise).*

Animal Industry—Continued.

*†J. E. Nordby, M. S., *Assoc. Prof. and Assoc. An. Husb.*

†E. F. Rinehart, B. S., *Field An. Husb. (P. O., Boise).*

Bacteriology: *†W. M. Gibbs, Ph. D., *Prof. Bact.; Bact.*

†H. W. Batchelor, B. S., *Asst. Bact.*

Botany: *F. W. Gail, Ph. D., *Assoc. Prof. and Actg. Head of Dept.*

*Lois Clark, Ph. D., *Asst. Prof. Bot.*

Chemistry: *†R. E. Neidigh, M. S., *Prof. Agr. Chem.; Chem.*

*E. J. Baldwin, M. S., *Asst. Prof. Chem.*

*L. C. Cady, B. S., *Instr. Chem.*

†F. H. Collins, B. S., *Asst. in Agr. Chem.*

*D. D. DuSault, B. S., *Asst. in Chem.*

*J. A. Kostalek, Ph. D., *Prof. Org. Chem.*

*S. J. Kroh, B. S., *Asst. Prof. Chem.*

†H. P. Magnuson, M. S., *Asst. Soil Chem.*

*†R. S. Snyder, B. S., *Asst. Prof. Agr. Chem.; Assoc. Chem.*

*C. L. von Ende, Ph. D., *Prof. Chem.*

Education (Agr.): *F. E. Armstrong, M. S., *Assoc. Prof. Agr. Ed. and Prin. School of Pract. Agr.*

*H. E. Lattig, B. S., *Supvr. Pract. Teaching in Agr.*

Engineering (Agr.): *†R. B. Gray, B. S. A. E., *Prof. Agr. Engin.; Agr. Engin.*

*†M. R. Lewis, B. S., *Assoc. Prof. Agr. Engin.; Irrig. Engin.*

Extension (Admin.): †Actg. Director Iddings in charge.

†A. W. B. Kjosness, B. S., *County Agt. Leader (P. O., Boise).*

—, *State Home Dem. Leader (P. O., Boise).*

†J. H. Rearden, B. S., *Asst. County Agt. Leader, in charge Junior Ext.*

Forestry: *†F. G. Miller, M. F., *Dean School of For.*

*H. I. Nettleton, B. S., *Instr. For.*

*Henry Schmitz, Ph. D., *Assoc. Prof. For. Products.*

*C. W. Watson, M. F., *Instr. For.*

Home Economics: *Katherine Jensen, M. S., *Prof. Home Econ., Dir. Home Econ. Curriculum.*

†Wilhelmina E. Jacobson, A. B., *Clothing Specialist (P. O., Boise).*

*Adah Lewis, M. S., *Assoc. Prof. Home Econ.*

*Mrs. Ruth P. McDole, B. S., *Asst. Prof. Home Econ.*

*Jessie Thornber, B. S., *Supvr. Pract. Teaching in Home Econ.*

*Grace Zudreele, B. S., *Asst. Prof. Art and Design*

Horticulture: *†C. C. Vincent, M. S., *Prof. Hort.; Hort.*

†E. R. Bennett, M. H., *Field Hort. (P. O., Boise).*

*†L. E. Longléy, M. S., *Assoc. Prof. and Assoc. Hort.*

*†C. V. Schrack, B. S., *Gardener.*

Plant Pathology: *†C. W. Hungerford, M. S., *Prof. Plant Path.; Plant Path. (Coop. U. S. D. A.).*

†J. M. Raeder, M. S., *Asst. Plant Path. (Coop. U. S. D. A.).*

Veterinary Science: *†B. L. Taylor, D. V. M., *Instr. and Asst. in Vet. Sci.*

Zoology and Entomology: *†J. E. Wodsedalek, Ph. D., *Prof. Zool. and Ent.; Ent.*

†W. E. Crouch, B. S., *Rodent Control Specialist (P. O., Boise).*

*Victor Jones, M. S., *Instr. Ent. and Lab. Asst. in Zool.*

*R. A. Muttkowski, Ph. D., *Assoc. Prof. Vertebrate Zool.*

††Claude Wakeland, B. S., *Ent. (P. O., Parma).*

Miscellaneous:

*††Grace L. Bennett, *Executive Secy.*

*†Mary B. Sweet, B. L. S., *Instr. Libr. Sci.; Libr.*

Substations:

Aberdeen—A. E. McClymonds, B. S., *Supt.*

Caldwell—D. A. Stubblefield, *Supt.*

Felt (High Altitude)—W. A. Moss, B. S., *Supt.*

Sandpoint—J. H. Christ, M. S., *Supt.*

ILLINOIS.

College of Agriculture and the Agricultural Experiment Station of the University of Illinois, Urbana.

*College faculty. †Station staff. ‡Extension staff.

*David Kinley, Ph. D., LL. D., *President of University.*

*†H. W. Mumford, B. S., *Dean Coll. of Agr., Dir. of Sta., Dir. of Agr. Ext. Service. Prof. An. Husb.*

M. S. Ketchum, C. E., *Dean Coll. of Engin., Dir. Engin. Expt. Sta.*

†Anna C. Glover, *Secy. and Mgr. of Pubs.*

†Florence E. Smith, B. S., *Chief Editorial Asst.*

Agronomy: *†W. L. Burlison, Ph. D., *Head Dept. of Agron. Prof. and Chief of Crop Prod.*

†J. C. Anderson, B. S., *First Asst. in Soil Fert.*

†C. J. Badger, B. S., *Asst. in Soil Survey Expt. Fields.*

††F. C. Bauer, Ph. D., *Prof. Soils Ext., Chief Soil Expt. Fields.*

†R. H. Bray, B. S., *Asst. in Soil Survey Anal.*

*†S. S. Carney, B. S., *Instr. and First Asst. in Crop Prod.*

†B. B. Clark, B. S., *Asst. in Soil Survey Mapping.*

*F. M. Clark, B. S., *Asst. in Soil Fert.*

†J. W. Coale, B. S., *Asst. in Soil Survey Mapping.*

†R. G. Crammond, B. S., *Asst. in Soil Survey Mapping.*

*†F. H. Crane, B. S., *Instr. and First Asst. in Soil Fert.*

Agronomy—Continued.

*†E. E. DeTurk, Ph. D., *Assoc. Prof. and Assoc. Chief Soil Tech.*

†O. I. Ellis, B. S., *Asst. Chief in Soil Survey Mapping.*

†J. M. Gibson, B. S., *Asst. in Soil Survey Mapping.*

††J. C. Hackleman, A. M., *Prof. and Chief in Crops Ext.*

*†M. B. Harland, B. S., *Instr. and First Asst. in Soil Phys.*

†M. A. Hein, B. S., *First Asst. in Soil Survey Expt. Fields.*

†W. P. Hiltbrand, B. S., *Assoc. in Soil Survey Mapping.*

†C. F. Hottes, Ph. D., *Consult. Plant Physiol.*

*†G. H. Iftner, B. S., *Asst. in Crop Prod.*

†A. H. Karraker, B. S., *Assoc. in Soil Survey Expt. Fields.*

†John Lamb, jr., B. S., *Assoc. in Soil Survey Expt. Fields.*

† For subject-matter workers see the respective division, i. e., agronomy, animal industry, etc.

‡ Given in College of Letters and Science.

Agronomy—Continued.

- †A. L. Lang, B. S., *Asst. in Soil Survey Expt. Fields.*
 *B. C. Lawson, B. S., *Asst. in Crop Prod.*
 †C. M. Linsley, B. S., *Assoc. in Soil Survey Expt. Fields.*
 †E. A. Norton, B. S., *First Asst. in Soil Survey Mapping.*
 *†J. J. Pieper, M. S., *Asst. Prof. and Asst. Chief in Crop Prod.*
 *†T. E. Richmond, M. S., *Assoc. in Soil Biol.*
 ††R. W. Scanlan, B. S., *Asst. in Soils Ext.*
 *†O. H. Sears, M. S., *Asst. Prof. and Asst. Chief in Soil Biol.*
 †L. H. Smith, Ph. D., *Chief in charge of Pubs. of Soil Survey.*
 *†R. S. Smith, Ph. D., *Assoc. Prof. and Assoc. Chief in Soil Phys., in charge Identification and Mapping of Soil Types.*
 †H. J. Snider, M. S., *Asst. Chief Soil Exp. Fields.*
 †V. E. Spencer, B. S., *First Asst. in Soil Fert.*
 †R. W. Stark, B. S., *Assoc. in Crop Prod.*
 †R. P. Thomas, B. S., *First Asst. in Soil Survey Expt. Fields.*
 †A. U. Thor, B. S., *Asst. in Soil Survey Expt. Fields.*
 *†D. C. Wimer, B. S., *Asst. Prof. and Asst. Chief in Soil Phys.*
 *F. L. Winter, B. S., *Asst. in Plant Brdg.*
 †M. I. Wolkoff, Ph. D., *Assoc. in Soil Survey Anal.*
 *†C. M. Woodworth, Ph. D., *Assoc. Prof. and Assoc. Chief in Plant Brdg.*

Animal Husbandry: *†H. P. Rusk, M. S., Head of Dept. Prof. and Chief, Cattle Husb.

- *†I. B. Boughton, D. V. M., *Assoc. in An. Path.*
 *†Sleeter Bull, M. S., *Assoc. Prof. An. Husb.; Assoc. Chief in Meats.*
 *†L. E. Card, Ph. D., *Prof. and Chief, Poultry Husb.*
 *†G. G. Carman, B. S., *Asst. in An. Nutr.*
 *†M. G. Clark, B. S., *Asst. in An. Husb.*
 *†C. W. Crawford, B. S., *Assoc. in An. Husb.*
 *†J. L. Edmonds, B. S., *Prof. and Chief, Horse Husb.*
 *†Robert Graham, D. V. S., B. S., *Prof. and Chief, An. Path. and Hyg.*
 *†H. S. Grindley, Sc. D., *Prof. and Chief, An. Nutr.*
 *†T. S. Hamilton, M. S., *Instr. and First Asst. in An. Nutr.*
 *†W. G. Kammlade, M. S., *Asst. Prof. and Asst. Chief, Sheep Husb.*
 †Mary H. Keith, M. A., *First Asst. in An. Nutr.*
 †F. E. Kendall, B. S., *Asst. in An. Nutr.*
 *†J. H. Knox, B. S., *Asst. in An. Husb.*
 *†R. J. Laible, B. S., *Instr. and First Asst. in An. Husb.*
 *†G. W. McIlroy, B. S., *Instr. and Specialist in Poultry Husb.*
 *†A. K. Mackey, B. S., *Asst. in An. Husb.*
 *†H. H. Mitchell, Ph. D., *Assoc. Prof. and Assoc. Chief, An. Nutr.*
 *†Elmer Roberts, Ph. D., *Asst. Prof. and Asst. Chief, An. Brdg.*

¹ Given in College of Education.² For subject-matter workers see the respective division, i. e., agronomy, animal husbandry, etc.**Animal Husbandry—Continued.**

- *†E. T. Robbins, M. S., *Asst. Prof. An. Husb. Ext.*
 *†R. R. Snapp, M. S., *Asst. Prof. An. Husb.; Asst. Chief, Beef Cattle Husb.*
 *†E. A. Tunnickliff, D. V. M., M. S., *Instr. and First Asst. in An. Path.*
 †Nao Uyei, B. S., *Asst. in An. Nutr.*
Dairy Husbandry: *†H. A. Ruehe, Ph. D., Head of Dept. Prof. and Chief, Dairy Mfrs.
 *†A. S. Ambrose, M. S., *Asst. Prof. and Asst. Chief, Dairy Mfrs.*
 *†J. M. Brannon, Ph. D., *Asst. Prof. and Asst. Chief, Dairy Bact.*
 *†M. H. Campbell, M. S., *Assoc. in Dairy Husb.*
 *†F. A. Davidson, B. S., *Instr. and First Asst. in Dairy Husb.*
 *W. J. Fraser, M. S., *Prof. Dairy Farming.*
 *†W. L. Gaines, Ph. D., *Prof. and Chief, Milk Prod.*
 †H. F. Hall, B. S., *First Asst. in Dairy Econ.*
 †H. E. Jamison, B. S., *Asst. in Dairy Ext.*
 *†W. B. Nevens, Ph. D., *Asst. Prof. and Asst. Chief, Dairy Cattle Feeding.*
 *†O. R. Overman, Ph. D., *Asst. Prof. and Asst. Chief, Dairy Chem.*
 ††C. S. Rhode, B. S., *Asst. Prof. and Asst. Chief, Dairy Ext.*
 *†M. J. Prucha, Ph. D., *Prof. and Chief, Dairy Bact.*
 *F. P. Sanmann, M. S., *Instr. Dairy Chem.*
 †Dee Small, B. S., *Asst. in Dairy Econ.*
 *†B. A. Stiritz, M. S., *Assoc. in Dairy Mfrs.*
 *†P. H. Tracy, M. S., *Instr. and First Asst. in Dairy Mfrs.*
 *†W. W. Yapp, Ph. D., *Asst. Prof. and Asst. Chief, Dairy Cattle.*

Education (Agr.):¹ *A. W. Nolan, M. S., Assoc. Prof. Agr. Ed.

- *C. S. Anderson, B. S., *Instr. Agr. Ed.*
 *J. E. Hill, B. S., *Assoc. in Agr. Ed.*
 *Anna B. Robinson, B. S., *Assoc. in Home Econ. Ed.*
 *Asia E. Todd, B. S., *Assoc. in Home Econ. Ed.*

Extension (Coop.):² Director Mumford in charge.

- *†W. H. Smith, M. S., *State Leader of Farm Advisers. Assoc. Prof. and Assoc. Chief in An. Husb. Ext.*
 *†J. D. Bilsborrow, B. S., *Asst. State Leader of Farm Advisers and Asst. Prof. Farm Organ and Mgt.*
 †E. I. Pilchard, B. S., *State Club Leader and An. Husb. Specialist.*
 †J. C. Spitzer, B. S., *Asst. State Leader of Farm Advisers.*
 †Vernon Vaniman, B. S., *Asst. State Leader of Farm Advisers.*
 †Nathalie Vasold, *Asst. in Junior Club Work*
Extension (Coll.): *†F. H. Rankin, B. S., Asst. Dean of Coll., Supt. of Agr. Coll. Ext.
 *†C. E. Gates, B. S., *Asst. in Agr. Coll. Ext.*
 *†R. E. Hieronymus, A. M., LL. D., *Community Adviser.*
 *†W. H. Young, *Assoc. in Agr. Coll. Ext.*

Farm Mechanics: *†E. W. Lehmann, B. S.,
Head of Dept.

*†I. P. Blauser, B. S., *Asst. in Farm Mech.*

*†F. P. Hanson, B. S., *Instr. and First Asst. in Farm Mech.*

*†R. C. Kelleher, B. S., *Asst. in Farm Mech.*

*†R. I. Shawl, M. S., *Asst. Prof. and Asst. Chief in Farm Mech.*

*†A. L. Young, M. S., *Instr. and First Asst. in Farm Mech.*

Farm Organization and Management:

*† — — —, *Head of Dept.*

*†H. C. M. Case, M. S., *Asst. Prof. and Asst. Chief in Farm Organ. and Mgt.*

†W. W. Ashbaugh, B. S., *Asst. in Farm Organ. and Mgt.*

†H. A. Berg, B. S., *Field Asst.*

*†C. A. Bonnen, M. S., *Assoc. in Farm Organ. and Mgt.*

†M. L. Mosher, B. S., *Assoc. in Farm Organ. and Mgt. Ext.*

†K. H. Myers, B. S., *Asst. in Farm Organ. and Mgt.*

*†Emil Rauchenstein, M. S., *Asst. Prof. and Asst. Chief in Farm Organ. and Mgt.*

†Lena C. Rhue, B. S., *Asst. in Farm Organ. and Mgt.*

†R. C. Ross, B. S., *Asst. in Farm Organ. and Mgt.*

Home Economics: *†Ruth A. Wardall, A. M.,
Head of Dept. and Vice Dir. of Home Econ. Ext.

*Miss H. L. Agar, B. S., *Asst. in Clothing.*

*Ethel Austin, M. S., *Instr. Foods.*

*Adelaide P. Barer, M. S., *Instr. Foods.*

*Irene M. Barnes, B. S., *Instr. Costume Design.*

*Harriet T. Barto, A. M., *Asst. Prof. Dietetics.*

*Lyda B. Burford, B. S., *Assoc. in Cafeteria Mgt.*

*Carlotta Ford, A. B., *Assoc. in Home Mgt.*

*Mate L. Giddings, A. B., *Instr. Home Econ.*

*Eda A. Jacobsen, A. M., *Asst. Prof. Clothing.*

*Helen McCullough, A. M., *Instr. Textiles.*

*Esther F. Rhode, B. S., *Asst. in Cafeteria.*

*Emma L. Wardell, M. S., *Asst. Prof. Nutr.*

*Virginia H. Weaver, M. A., *Assoc. in Home Decoration.*

*Mary S. Wenger, M. S., *Instr. Nutr.*

*Mary C. Whitlock, M. S., *Assoc. in Clothing.*

†Grace B. Armstrong, A. M., *Specialist in Foods and Nutr.*

Home Economics—Continued.

†Edna R. Gray, B. S., *Clothing Specialist.*

†Margia B. Haugh, Ph. B., *Clothing Specialist.*

†Mabel M. Hollis, B. S., *Specialist in Home Furnishings.*

†Emma E. Sparks, *Asst. State Leader Home Econ. Ext.*

†Kathryn G. Van Aken, A. B., *State Leader of Home Econ. Ext.*

†Myrtle Weldon, A. M., *Asst. State Leader of Home Econ. Ext.*

Horticulture: *†J. C. Blair, Sc. D., *Head of Dept.*

*†H. W. Anderson, Ph. D., *Asst. Prof. and Asst. Chief, Pomol. Path.*

*R. W. Axt, B. S., *Asst. in Oler.*

*Harland Bartholomew, C. E., *Asst. Prof. Civic Design.*

†W. S. Brock, B. S., *Asst. Prof. Hort. Ext.*

*†F. E. Carver, B. S., *Instr. and First Asst. in Pomol.*

*†A. S. Colby, Ph. D., *Assoc. Prof. and Assoc. Chief in Pomol.*

*†C. S. Crandall, M. S., *Prof. Pomol.; Chief in Plant Brdg.*

*†C. S. Dale, M. S., *Assoc. in Oler.*

*†H. B. Dornier, M. S., *Prof. and Chief, Flor.*

†G. E. Fager, B. S., *Assoc. in Plant Brdg.*

*†S. W. Hall, B. S., *Asst. Prof. and Asst. Chief, Flor.*

*†W. A. Huelsen, B. S., *Assoc. in Oler.*

†James Hutchinson, *Assoc. in Flor.*

†H. F. Jenkins, M. S., *Research Asst. in Oler.*

*V. W. Kelley, M. S., *Assoc. in Pomol.*

*†J. W. Lloyd, Ph. D., *Prof. and Chief, Oler.*

*K. B. Lohmann, M. L. A., *Assoc. Prof. Landsc. Gard.*

*May E. McAdams, B. S., *Assoc. in Landsc. Gard.*

*†Z. H. Mohlman, B. S., *Instr. and First Asst. in Flor.*

*†F. W. Newton, B. S., *Instr. and First Asst. in Pomol.*

*L. I. Peterson, B. S., *Assoc. in Landsc. Gard.*

*†W. A. Ruth, Ph. D., *Asst. Prof. and Asst. Chief, Pomol. Physiol.*

*†C. B. Sayre, B. S., *Asst. Prof. and Asst. Chief, Oler.*

*O. G. Schaffer, B. S., *Assoc. in Landsc. Gard.*

*†A. C. Vogeley, M. S., *Assoc. in Pomol.*

*†F. F. Weinard, Ph. D., *Assoc. in Flor. Physiol.*

*S. H. White, M. L. A., *Asst. Prof. Landsc. Gard.*

INDIANA.

Purdue University (the School of Agriculture, the Agricultural Experiment Station, and the Departments of Home Economics and Agricultural Extension), La Fayette.

*College faculty. †Station staff. ‡Extension staff.

*E. C. Elliott, Ph. D., *President of University.*

*†J. H. Skinner, B. S., *Dean School of Agr.*

††G. I. Christie, B. S., *Dir. of Sta., Dir. Dept. of Agr. Ext.*

A. A. Potter, S. B., *Dean Schools of Engin., Dir. Engin. Expt. Sta.*

Agronomy: *†M. L. Fisher, M. S., *Head of Dept., Asst. Dean School of Agr.; Asst. Chief in Soils and Crops.*

†H. J. Reed, *Farm Dir. and Asst. Dir. of Sta.*

*†A. T. Wiancko, B. S., *Prof. Agron.; Chief in Soils and Crops.*

Agronomy—Continued.

†T. M. Bushnell, B. S., *Assoc. in Soil Survey.*

*C. U. Gramelspacher, M. S., *Asst. in Agron.*

*†W. C. Latta, M. S., *Prof. Agr., Consult. Specialist in Ext.*

†R. R. Mulvey, B. S., *Asst. in Soils.*

Agronomy—Continued.

- †W. A. Ostrander, M. S., *Asst. in Soils and Crops.*
 †M. J. Plice, B. S., *Asst. in Soils and Crops.*
 *F. E. Robbins, M. S., *Assoc. Prof. Crop Prod.*
 *J. P. Seaton, B. S., *Instr. Soils.*
 †R. S. Thomas, B. S., *Asst. in Soils and Crops.*
 †G. P. Walker, B. S., *Assoc. in Soils and Crops.*
 *R. C. E. Wallace, B. S., *Prof. Soils.*
- Animal Husbandry:** Dean Skinner *in charge.*
- *†A. G. Philips, B. S., *Prof. in charge Poultry Husb.*
 †F. G. King, B. S., *Asst. Chief in An. Husb.*
 *†F. D. Brooks, B. S., *Instr. and Asst. in Poultry Husb.*
 †C. W. Carrick, Ph. D., *Assoc. in Poultry Husb.*
 *†R. B. Cooley, B. S., *Asst. Prof. An. Husb.; Secy. Stallion Enrollment Board.*
 †H. W. Fitting, B. S., *Asst. in Poultry Husb. Ext.*
 *C. F. Gobble, M. Agr., *Assoc. Prof. An. Husb.*
 †Claude Harper, M. S., *Assoc. in An. Husb. Ext.*
 †L. L. Jones, B. S., *Assoc. in Poultry Husb. Ext.*
 *R. L. McCally, B. S., *Instr. An. Husb.*
 *W. M. McVey, B. S., *Instr. An. Husb.*
 *B. E. Pontius, B. S., *Asst. Prof. An. Husb.*
 †P. G. Riley, B. S., *Asst. in Poultry Ext.*
 †J. W. Schwab, B. S., *Assoc. in An. Husb.*
 *†L. H. Schwartz, B. S., *Asst. Prof. and Asst. Poultry Husb.*
 *W. W. Smith, M. S., M. Agr., *Prof. An. Husb.*
 †C. M. Vestal, B. S., *Assoc. in An. Husb.*
 †J. R. Wiley, B. S., *Asst. in An. Husb.*

Biology: *Stanley Coulter, Ph. D., LL. D., *in charge.*

- *I. L. Baldwin, M. S., *Instr. Bact.*
 *C. A. Behrens, Ph. D., *Prof. Bact.*
 *H. E. Enders, Ph. D., *Prof. Zool. in charge Gen. Biol.*
 *C. M. James, M. S., *Asst. in Anat. and Physiol.*
 *O. P. Terry, M. S., *Prof. Anat. and Physiol.*
 *P. A. Tetrault, M. S., *Assoc. Prof. Bact.*

Botany: †H. S. Jackson, A. B., *in charge.*

- *E. G. Campbell, Ph. D., *Asst. Prof. Bot.*
 †L. E. Compton, B. S., *Field Asst. in Plant Path. (Detailed by U. S. D. A.).*
 †M. W. Gardner, Ph. D., *Assoc. in Bot.*
 †C. T. Gregory, Ph. D., *Assoc. in Bot.*
 ††A. A. Hansen, M. S., *Assoc. in Bot.*
 *L. F. Heimlich, M. S., *Assoc. Prof. Bot.*
 †G. N. Hoffer, D. Sc., *Assoc. in Bot. (Coop. U. S. D. A.).*
 †J. B. Kendrick, M. S., *Asst. in Bot.*
 †Jane C. Kinsella, B. S., *Sci. Asst. in Seed Lab. (Detailed by U. S. D. A.).*
 *E. J. Kohl, M. S., *Instr. Bot.*
 †E. B. Mains, Ph. D., *Assoc. in Bot. (Coop. U. S. D. A.).*
 *J. W. Miller, M. S., *Instr. Plant Path. and Physiol.*
 †Alice S. Patt, *Asst. Seed Analyst.*
 †Edith M. Patt, *Seed Analyst.*
 *C. L. Porter, Ph. D., *Asst. Prof. Plant Path. and Physiol.*
 †G. M. Smith, M. S., *Asst. Path. (Detailed by U. S. D. A.).*

Botany—Continued.

- †Dorothy M. Thompson, B. S., *Asst. in Bot.*
 †J. F. Trost, M. S., *Asst. Path. (Detailed by U. S. D. A.).*

Chemistry: *P. N. Evans, Ph. D., *in charge.*

- *R. H. Carr, Ph. D., *Prof. Agr. Chem.*
 †W. C. Aitkenhead, B. S., *Deputy State Chem.*
 *F. J. Allen, M. S., *Instr. Chem.*
 †C. C. Baker, B. S., *Insp. State Chem. Dept.*
 †R. O. Bitler, B. S., *Deputy State Chem.*
 †G. G. Carter, B. S., *Insp. State Chem. Dept.*
 †S. D. Conner, M. S., *Assoc. Chem. in Soils and Crops.*
 †P. B. Curtis, B. S., *Deputy State Chem.*
 *Eli Duncombe, M. S., *Instr. Chem.*
 †A. S. Eldridge, *Insp. State Chem. Dept.*
 †O. W. Ford, A. B., *Deputy State Chem.*
 *G. K. Foresman, M. S., *Instr. Chem.*
 †S. M. Hauge, M. S., *Research Asst. in An. Nutr.*
 †L. E. Horat, B. S., *Deputy State Chem.*
 *F. J. McClure, B. S., *Instr. Chem.*
 *M. G. Mellon, Ph. D., *Asst. Prof. Chem.*
 *A. R. Middleton, Ph. D., *Prof. Inorg. Chem.*
 *R. C. Newton, B. S., *Instr. Chem.*
 *†E. G. Proulx, M. S., *Prof. Agr. Chem.; State Chem. and Seed Comr.*
 †O. S. Roberts, B. S., *Chief Insp. State Chem. Dept.*
 *L. A. Test, Ph. D., *Prof. Gen. Chem.*
 †M. H. Thornton, *Deputy State Chem.*

Dairy Husbandry: *†H. W. Gregory, M. S., *in charge.*

- †T. H. Binney, M. S., *Asst. in Creamery Insp.*
 *K. V. Bryan, M. S., *Asst. Prof. Dairying.*
 †R. D. Canan, M. S., *Asst. in Dairy Husb. Ext.*
 †W. F. Eppler, Ph. C., B. S., *Asst. Dairy Chem.*
 *†L. H. Fairchild, B. S., *Assoc. Prof. Dairying; Assoc. in Milk Prod.*
 †E. A. Gannon, B. S., *Assoc. Dairy Husb. Ext.*
 †W. G. Goss, B. S., *Asst. in Creamery Insp.*
 †V. C. Manhart, B. S., *Asst. in Dairy Mfrs.*
 *†E. H. Parfitt, B. S., *Instr. Dairy Bact.; Dairy Bact.*
 †George Spitzer, Ph. G., B. S., *Assoc. in Dairy Chem.*
 †J. W. Wilbur, M. S., *Asst. in Dairy Prod.*
 †G. A. Williams, M. S., *Asst. in Dairy Husb. Ext.*

Education (Agr.): *S. S. Cromer, B. S., *Prof. Agr. Ed.*

- *J. R. Behr, B. S., *Asst. in Voc. Agr.*
 *Pauline H. Drollinger, M. S., *Asst. in Voc. Home Econ.*
 *C. W. Hemmer, B. S., *Asst. in Voc. Agr.*
 *S. P. Pershing, B. S., *Asst. in Voc. Agr.*

Engineering (Rural): *†William Aitkenhead, M. E., M. A., *Prof. Farm Mech.; Chief in Rural Engin.*

- *C. C. Cunningham, B. S. C. E., *Asst. Prof. Farm Mech.*
 †T. E. Hienton, B. S., *Agr. Engin. Ext.*
 *F. C. Lewis, M. S., *Asst. Prof. Farm Mech.*
 *R. B. Goss, *Instr. Farm Mech.*
 †I. D. Mayer, B. S., *Asst. in Rural Engin.*

Entomology: *†J. J. Davis, B. S., *in charge.*

- †C. R. Cleveland, A. B., *Asst. Ent.*
 *W. A. Price, M. S., *Assoc. Prof. Ent.*
 *James Troop, M. S., *Prof. Ent.*

Extension (Admin.) †Director Christle *in charge*.†T. A. Coleman, *Asst. Dir. and County Agt. Leader*.†Lella R. Gaddis, *State Home Dem. Leader*.†Z. M. Smith, A. M., *State Club Leader*.†E. L. Austin, B. S., *Asst. State Club Leader*.†W. Q. Fitch, B. S., *State Leader of Farmers' Institutes*.†G. M. Frier, B. S., *Assoc. in Short Courses and Exhibits*.†L. G. Gordner, B. S., *Asst. in Short Courses and Exhibits*.†M. L. Hall, B. S., *Asst. State Club Leader*.†Mabel L. Harlan, *Asst. in Ext. Admin.*†Leroy Hoffman, B. S., *Asst. County Agt. Leader*.†T. R. Johnston, *Asst. County Agt. Leader*.†W. V. Kell, *Asst. County Agt. Leader*.†Rosina C. Kistner, A. B., *Asst. State Club Leader*.†L. S. Robertson, B. S., *State Leader in Farm Mgt. Dem.*†F. M. Shanklin, A. M., *Asst. State Club Leader*.†Neva M. Stephenson, B. S., *Asst. State Club Leader*.**Farm Management and Rural Economics:***†O. G. Lloyd, M. S., *in charge*.*†O. F. Hall, A. B., S. T. B., *Assoc. Prof. Ed. Sociol., Assoc. in Rural Life Studies*.†M. H. Overton, B. S., *Assoc. in Farm Mgt.**W. E. Paulson, Ph. D., *Asst. Prof. Farm Mgt. and Rural Econ.**†E. C. Young, Ph. D., *Asst. Prof. Farm Mgt. and Rural Econ.; Asst. in Farm Mgt.***Forestry:** *B. N. Prentice, M. F., *Assoc. Prof. For.***Home Economics:** *Mary L. Matthews, B. S., *in charge*.†Aneta P. Beadle, B. S., *Asst. in Home Econ. Ext.**Amy I. Boye, Ph. B., *Instr. Home Econ.**Laura J. Cheney, M. A., *Instr. Home Econ.*†Madeleine Connor, A. B., *Asst. in Home Econ. Ext.*†Nelle K. Flaningham, *Asst. in Home Econ. Ext.**M. Edith Gamble, M. A., *Asst. Prof. Home Econ.**Amy Howe, Ph. B., *Asst. Prof. Home Econ.*†Ruth Jordan, B. S., *Asst. in Home Econ.***Home Economics—Continued.***Conradina H. Lommel, B. S., *Asst. in Home Econ.**Katherine H. McFarland, M. S., *Instr. Home Econ.*†Mrs. L. E. McKinley, B. S., *Asst. in Home Econ. Ext.**Margaret G. Mallon, M. S., *Asst. Prof. Home Econ.*†Meta E. Martin, B. S., *Asst. in Home Econ. Ext.**Edith Palmer, B. S., *Asst. Prof. Home Econ.**Laura A. Partch, B. S., *Instr. Home Econ.**Gladys Peckinbaugh, B. S., *Asst. in Home Econ.**Bonnie E. Scholes, M. A., *Asst. Prof. Home Econ. Ed.**Marie E. Schrass, B. S., *Asst. in Home Econ.**Lucy W. Wade, B. S., *Instr. Home Econ.***Horticulture:** *†Laurenz Greene, M. S., *in charge*.*O. G. Anderson, B. S., *Prof. Hort.*†C. E. Baker, B. S., *Asst. in Pomol.**†H. D. Brown, M. S., *Assoc. Prof. and Research Assoc. in Veg. Gard.*†C. L. Burkholder, B. S., *Assoc. in Hort.*†F. P. Cullinan, B. S., *Research Assoc. in Pomol.*†F. C. Gaylord, B. S., *Assoc. in Hort.*†I. C. Hoffman, M. S., *Asst. in Veg. Gard.**W. E. Lommel, B. S., *Assoc. Prof. Hort.**†V. H. Ries, M. S., *Asst. Prof. and Asst. in Flor.***Physics:** *E. S. Ferry, B. S., *in charge*.*Elizabeth Mitchell, A. M., *Instr. Phys.**J. G. Moorhead, A. B., *Asst. in Phys.***Veterinary Science:** *†R. A. Craig, D. V. M., *in charge*.†F. J. Cason, *Asst. in Serum Prod.*†D. B. Clark, M. D. C., *Assoc. Vet.*†L. P. Doyle, B. S., *Assoc. in An. Path.*†L. R. George, B. S., *Asst. An. Path.*†F. P. Mathews, B. S., D. V. M., *Asst. in Vet. Sci.**†G. H. Roberts, V. S., V. M. D., *Assoc. Prof. Vet. Sci.; Assoc. Vet.*†F. L. Walkey, D. V. M., *Asst. An. Path.**†R. A. Whiting, D. V. M., *Instr. Vet. Sci.; Assoc. in An. Path.***Miscellaneous:**††J. C. Allen, *Photog.**W. M. Hepburn, M. A., B. L. S., *Libr.***IOWA.****Iowa State College of Agriculture and Mechanic Arts and the Agricultural Experiment Station, Ames.**

*College faculty. †Station staff. ‡Extension staff.

*R. A. Pearson, M. S., LL. D., D. Agr., *President*.*†C. F. Curtiss, D. Sc., *Dean Div. of Agr., Dir. of Sta.*†R. K. Bliss, B. S., *Dir. of Agr. Ext.*Anson Marston, C. E., *Dean Div. of Engin., Dir. Engin. Expt. Sta.***Animal Husbandry:** *†H. H. Kildee, M. S.,*Head of Dept., Vice Dean of Coll.; Chief An. Husb.**†Earl Weaver, M. S., *Prof. Dairy Husb.; Chief Dairy Husb.**†H. A. Bittenbender, B. S., *Prof. Poultry Husb.; Chief Poultry Husb.***Animal Husbandry—Continued.***A. L. Anderson, M. S., *Assoc. Prof. An. Husb.**R. G. Anderson, B. S., *Instr. An. Husb.*†J. H. Bardsley, M. S., *Ext. Asst. Prof. Poultry Husb.**W. E. Beanblossom, B. S., *Instr. An. Husb.*†Rex Beresford, B. S., *Ext. Prof. An. Husb.*¹ For subject-matter workers see the respective division, i. e., agronomy, animal husbandry, etc.

Animal Husbandry—Continued.

- *C. A. Burge, M. S., *Instr. An. Husb.*¹
 *†A. B. Caine, M. S., *Assoc. Prof. An. Husb.; Chief in Horse Invest.*
 *†R. L. Cochran, M. S., *Asst. Prof. Poultry Husb.; Asst. Chief Poultry Husb.*
 †C. C. Culbertson, B. S., *Asst. Chief An. Husb.*
 *†Fordyce Ely, M. S., *Asst. Prof. and Asst. Chief Dairy Husb.*
 *†J. M. Evvard, M. S., *Prof. An. Husb.; Chief in Swine and Beef Cattle Invest.*
 †C. B. Finley, M. S., *Ext. Assoc. Prof. Dairy Prod.*
 †L. C. Funk, M. S., *Ext. Asst. Prof. Dairy Prod.*
 †W. E. Hammond, M. S., *Supt. An. Husb. Expts.*
 *J. G. Hammer, *Farm Supt.*
 †L. E. Heifner, *Poultry Club Work.*
 *†M. D. Helsler, M. S., *Prof. An. Husb.; Chief in Meat Invest.*
 *J. C. Holbert, B. S., *Instr. An. Husb.*
 *†M. L. Jones, *Supt. Poultry Farm.*
 *C. W. Knox, M. S., *Instr. Poultry Husb.*
 *W. F. LaGrange, B. S., *Prof. An. Husb.*¹
 †A. R. Lamb, M. S., *Chief in Nutr., Asst. Chem.*
 †W. H. Lapp, M. S., *Ext. Prof. Poultry Husb.*
 †C. W. McDonald, M. S., *Ext. Assoc. Prof. An. Husb.*
 *W. F. Nussbaum, B. S., *Instr. Poultry Husb.*¹
 †E. L. Quaife, B. S., *Ext. Assoc. Prof. An. Husb.*
 *J. R. Redditt, B. S., *Instr. Poultry Husb.*¹
 *†J. M. Shaw, B. S., *Instr. and Asst. Chief Dairy Husb.*
 *†P. S. Shearer, B. S., *Prof. An. Husb.; Chief in An. Brdg.*
 †R. W. Snyder, M. S., *Ext. Asst. in An. Husb.*
 †J. N. Spencer, *Ext. Asst. in Dairy Prod.*
 *R. S. Stephenson, M. S., *Assoc. Prof. An. Husb.*
 *†David Taylor, B. S., *Dairy Cattle Herdsman.*
 *W. M. Vernon, M. S., *Asst. Prof. Poultry Husb.*¹
 †Q. W. Wallace, M. S., *Asst. in An. Husb.*
 †J. J. Warren, B. S., *Ext. Asst. Prof. Poultry Husb.*

Bacteriology: *†R. E. Buchanan, Ph. D., *Head of Dept., and Dean of Grad. Coll.; Chief Bact.*

- *Clarissa M. Clark, B. S., *Instr. Bact.*
 *Max Levine, Ph. D., *Assoc. Prof. Bact.*
 *J. C. Weldin, M. S., *Instr. Bact.*
 *C. H. Werkman, Ph. D., *Instr. Bact.*

Botany and Plant Pathology: *†L. H. Pammel, Ph. D., *Head of Dept.; Chief Bot.*

- *†I. E. Melhus, Ph. D., *Prof. Plant Path.; Chief Plant Path.*
 *†A. L. Bakke, Ph. D., *Assoc. Prof. and Asst. Bot.*
 *E. F. Castetter, M. S., *Instr. Bot.*
 *R. I. Cratty, *Curator.*
 †L. W. Durrell, Ph. D., *Asst. Chief Plant Path.*
 *J. C. Gilman, Ph. D., *Asst. Prof. Plant Path.*
 *Ada Hayden, Ph. D., *Asst. Prof. Bot.*
 †Charlotte M. King, *Asst. Chief Bot.*
 *†J. N. Martin, Ph. D., *Prof. Bot.; Asst. Bot.*
 ††R. Porter, B. S., *Ext. Asst. in Plant Path.*

¹ Noncollegiate course.**Chemistry:** *W. F. Coover, A. M., *Head of Dept.*

- †W. G. Gaessler, M. S., *Actg. Chief Chem.*
 *L. T. Anderegg, M. S., *Asst. Prof. Chem.*¹
 *F. E. Brown, Ph. D., *Prof. Inorg. Chem.*
 *J. H. Buchanan, M. S., *Assoc. Prof. Food and Sanitary Chem.*
 *J. A. Burrows, M. S., *Instr. Chem.*
 *O. W. Chapman, M. S., *Instr. Chem.*
 *N. A. Clark, Ph. D., *Asst. Prof. Inorg. Chem. and Soils.*
 *W. W. Duecker, B. S., *Instr. Chem.*
 *E. I. Fulmer, Ph. D., *Assoc. Prof. Biophys. Chem.*
 †Fisk Gerhardt, M. S., *Asst. Chem.*
 *Henry Gilman, Ph. D., *Prof. Org. Chem.*
 *J. W. Hawks, M. S., *Instr. Chem.*
 *L. C. Heckert, B. S., *Instr. Chem.*
 *R. M. Hixon, Ph. D., *Asst. Prof. Plant Chem.*
 *H. M. McLaughlin, M. A., *Instr. Chem.*
 *G. G. Naudain, Ph. D., *Instr. Chem.*
 *Nellie Naylor, Ph. D., *Asst. Prof. Gen. and Enzyme Chem.*
 *V. E. Nelson, M. S., *Prof. Physiol. Chem. and Nutr.*
 *Ruth O'Brien, Ph. D., *Assoc. Prof. Household Chem.*
 *E. M. Roller, M. S., *Instr. Chem.*
 *C. W. Saunders, M. S., *Instr. Chem.*
 †J. A. Schulz, B. S., *Asst. Chem.*
 *R. B. Waite, M. S., *Instr. Chem.*
 *J. A. Wilkinson, Ph. D., *Prof. Inorg. Chem.*
 *H. W. Wright, B. S., *Instr. Chem.*

Dairying: *†Martin Mortensen, B. S., *Head of Dept.; Chief in Dairying.*

- *†B. W. Hammer, Ph. D., *Prof. Dairy Bact.; Chief Dairy Bact.*
 †M. P. Baker, M. S., *Asst. in Dairying.*
 †J. J. Brunner, *Ext. Asst. in Dairy Mfrs.*
 *G. G. DeBord, Ph. D., *Asst. Prof. Dairy Bact.*
 *E. F. Goss, M. S., *Assoc. Prof. Dairying.*¹
 *P. I. Henderson, B. S., *Instr. Dairying.*¹
 *F. C. Hulse, *Instr. Dairying.*
 *L. S. Hyde, M. S., *Instr. Dairying.*
 *C. A. Iverson, M. S., *Assoc. Prof. Dairying.*
 *R. L. Neasham, M. S., *Instr. Dairying.*
 †A. W. Rudnick, B. S., *Ext. Prof. Dairy Mfrs.*
 †F. M. Sheldon, B. S., *Ext. Asst. Prof. Dairy Mfrs.*
 †F. F. Sherwood, M. A., *Asst. Chief in Dairying.*

Economics (Agr.), Farm Management, and Rural Sociology: *†C. L. Holmes, Ph. D., *Prof. Agr. Econ.; Chief of Agr. Econ. and Farm Mgt. Sec.*

- *†G. H. Von Tungeln, M. A., *Prof. Rural Sociol.; Chief of Rural Sociol. Sec.*
 †L. G. Allbaugh, B. S., *Asst. Farm Mgt. Dem.*
 *†Knut Bjorka, M. S., *Asst. Prof. and Asst. in Agr. Econ. and Farm Mgt.*
 †C. W. Crickman, B. S., *Asst. in Agr. Econ. and Farm Mgt.*
 †F. Gladys Draper, B. S., *Asst. in Agr. Econ. and Farm Mgt.*
 †W. O. Duncan, B. S., *Asst. in Agr. Econ.*
 †J. C. Galloway, B. S., *Farm Mgt. Dem.*

Economics (Agr.), Farm Management, and Rural Sociology—Continued.

- *†F. L. Garlock, M. A., *Asst. Prof. and Asst. in Agr. Econ.*
 †C. W. Hammans, M. S., *Field Agt. in Marketing.*
 *W. L. Harter, M. S., *Assoc. Prof. Agr. Econ. and Farm Mgt.*¹
 *H. B. Hawthorn, Ph. D., *Asst. Prof. Rural Sociol.*
 *†J. A. Hopkins, jr., Ph. D., *Asst. Prof. and Asst. in Agr. Econ. and Farm Mgt.*
 †H. G. Loomer, M. S., *Asst. in Agr. Econ.*
 *†P. L. Miller, M. A., *Assoc. Prof. Agr. Econ.; Asst. Chief Agr. Econ. and Farm Mgt.*
 *Millard Peck, B. S., *Instr. Agr. Econ. and Farm Mgt.*¹
 *††Frank Robotka, M. S., *Asst. Prof. and Asst. in Agr. Econ. Marketing.*
 †H. B. Rowe, B. S., *Ext. Asst. in Farm Mgt.*
 †W. H. Stacy, M. S., *Ext. Assoc. Prof. Rural Organ.*
 †J. F. Thaden, M. S., *Asst. in Rural Sociol.*
 †S. H. Thompson, M. S., *Ext. Prof. Agr. Econ.*
 †W. H. Youngman, B. S., *Asst. in Agr. Econ.*

Education (Agr.): *W. H. Lancelot, B. S., *Prof. and Actg. Head of Dept.*

- *P. I. Barker, B. S., *Instr. Voc. Ed.*
 *W. H. Bender, B. S., *Asst. Prof. Voc. Ed.*
 *H. M. Hamlin, M. S., *Assoc. Prof. Voc. Ed.*
 *Barton Morgan, M. S., *Instr. Voc. Ed.*
 *J. A. Starrak, M. S., *Instr. Voc. Ed.*
 *H. B. Swanson, B. S., *Instr. Voc. Ed.*

Engineering (Agr.): *†J. B. Davidson, M. E., A. E., *Head of Dept.; Chief of Agr. Engin. Sec.*

- *Q. C. Ayres, B. S., B. Eng., *Assoc. Prof. Agr. Engin.*
 †A. W. Clyde, B. S. A. E., *Ext. Prof. Agr. Engin.*
 †E. V. Collins, B. S. A. E., *Asst. Chief in Agr. Engin. Sec.*
 *†F. C. Fenton, B. S. A. E., *Assoc. Prof. Agr. Engin.*
 *H. F. Hertz, *Instr. Agr. Engin.*
 *E. M. Mervine, M. E., *Assoc. Prof. Agr. Engin.*
 *H. Z. Rynerson, *Instr. Agr. Engin.*¹
 †H. H. Sunderlin, B. S. A. E., *Ext. Assoc. Prof. Agr. Engin.*
 *A. W. Turner, B. S. A. E., *Assoc. Prof. Agr. Engin.*¹
 *H. L. Wallace, M. S. A. E., *Instr. Agr. Engin.*

Extension (Admin.):² Director Bliss in charge.

- †Murl McDonald, B. S., *Asst. Dir.*
 †P. C. Taff, B. S., *Asst. Dir. and State Club Leader.*
 †Neale S. Knowles, *State Home Dem. Leader.*
 †Ida V. Ahrens, B. S., *Asst. State Club Leader.*
 †Josephine A. Arnquist, B. S., *Asst. State Club Leader.*
 †Mrs. Edith Barker, *Asst. State Club Leader.*
 †Grant Chapman, *Asst. County Agt. Leader.*
 †W. L. Harper, *Secy.*
 †H. J. Metcalf, in charge *Information Service.*
 †J. S. Quist, B. S., *Asst. State Club Leader.*

¹ Noncollegiate course.² For subject-matter workers see the respective division, i. e., animal husbandry, bacteriology, etc.**Extension (Admin.)—Continued.**

- †F. P. Reed, B. S., *Asst. State Club Leader.*
 †Avis Talcott, B. S., *Asst. State Home Dem. Leader.*

Farm Crops and Soils: *†W. H. Stevenson, D. Sc., *Head of Dept.; Vice Dir. of Sta. and Chief Agron. Dir. of Soil Survey.*

- *†P. E. Brown, Ph. D., *Prof. Soils; Chief Soil Chem. and Bact. Assoc. Dir. of Soil Survey.*
 †L. C. Burnett, M. S., *Chief in Cereal Brdg. (Coop. U. S. D. A.).*
 †L. W. Forman, M. S., *Chief in Field Expts.*
 *†H. D. Hughes, M. S., *Prof. Farm Crops; Chief in Farm Crops.*
 †W. G. Baker, B. S., *Asst. in Field Expts.*
 †T. H. Benton, M. S., *Soil Surveyor.*
 †Bryan Boatman, B. S., *Soil Asst. in Field Expts.*
 †J. L. Boatman, B. S., *Asst. in Field Expts.*
 †F. G. Churchill, B. S., *Ext. Prof. Farm Crops and Soils.*
 *C. S. Dorchester, M. S., *Asst. Prof. Farm Crops*
 *F. K. Dubbert, B. S., *Instr. Farm Crops and Soils.*¹
 *J. C. Eldredge, B. S., *Asst. Prof. Farm Crop*
 *Paul Emerson, Ph. D., *Assoc. Prof. Soils.*
 *†L. W. Erdman, Ph. D., *Asst. Prof. Soils; Asst. Chief in Soil Bact.*
 *E. T. Erickson, M. S., *Asst. Prof. Farm Crops and Soils.*¹
 *B. J. Firkins, M. S., *Asst. Prof. Soils.*
 †D. S. Gray, B. S., *Soil Surveyor.*
 *†H. J. Harper, Ph. D., *Assoc. Prof. Soils; Asst. Chief Soil Chem.*
 †M. A. Hauser, B. S., *Ext. Prof. Farm Crops and Soils (P. O., Marshalltown).*
 *E. R. Henson, M. S., *Asst. Prof. Farm Crops.*
 *D. R. Johnson, M. S., *Assoc. Prof. Soils.*
 †A. M. O'Neal, jr., B. S., *Soil Surveyor.*
 †C. L. Orrben, B. S., *Soil Surveyor.*
 *O. E. Overeth, M. S., *Instr. Soils.*
 †J. L. Robinson, M. S., *Supt. Coop. Expts.*
 *D. C. Thayer, M. S., *Instr. Soils.*
 *R. M. Vifquain, M. A., *Assoc. Prof. Farm Crops and Soils.*¹
 †H. W. Warner, M. S., *Ext. Assoc. Prof. Soils.*
 *J. B. Wentz, M. S., *Assoc. Prof. Farm Crops.*
 †F. S. Wilkins, M. S., *Asst. Chief in Forage Crops.*

Genetics: *†E. W. Lindstrom, Ph. D., *Head of Dept.; Chief Geneticist.*

- *W. A. Carver, M. S., *Asst. in Genetics.*
 *W. V. Lambert, M. S., *Instr. Genetics.*

Home Economics: *Anna E. Richardson, M. A., *Dean of Div.*

- *Edna E. Walls, Ph. B., B. S., *Vice Dean.*
 *Iva L. Brandt, B. S., *Head Household Art Dept.*
 *Florence E. Busse, M. A., *Head Household Sci. Dept.*
 *Joanna M. Hansen, B. A., *Head Applied Art Dept.*
 *Cora B. Miller, B. S., *Head Teacher Training Dept.*
 *Ida A. Anders, B. S., *Asst. Prof. Teacher Training.*

Home Economics—Continued.

- *Ruby Arneson, B. S., *Asst. Prof. Applied Art.*
 †Margaret M. Baker, M. S., *Specialist in Foods and Nutr.*
 *Susan L. Bates, B. S., *Assoc. Prof. Household Art.*
 *Viola M. Bell, M. A., *Assoc. Prof. Household Sci.*
 *Agnes Broemel, B. S., *Instr. Applied Art.*
 *Mrs. Linda S. Brown, M. A., *Asst. Prof. Institutional Admin.*
 *Dorothy H. Chadwick, Ph. B., *Instr. Teacher Training.*
 *Katherine T. Cranor, A. M., *Prof. Household Art.*
 *Eloise Davison, B. S., *Asst. Prof. Household Sci.*
 *Ruetta T. Day, M. A., *Asst. Prof. Household Sci.*
 *M. Arlyn Eilert, M. A., *Instr. Applied Art.*
 †Mildred Elder, B. S., *Clothing Specialist.*
 *Florence Faust, B. A., *Instr. Household Art.*
 *Mabel C. Fisher, *Instr. Applied Art.*
 †Martha E. Foster, B. S., *Clothing Specialist.*
 *Regina J. Friant, Ph. B., M. A., *Asst. Prof. Voc. Ed.*
 *Mary L. Gabrielson, M. A., *Instr. Household Art.*
 *Marion B. Gardner, *Instr. Applied Art.*
 *Electa Gibson, B. S., *Instr. Home Econ.*¹
 *Mrs. E. F. Graff, *Instr. Applied Art.*
 †Marie Hall, B. S., *Clothing Specialist.*
 †Alma Heiner, B. S., *Clothing Specialist.*
 *Anna M. Henderson, *Asst. Prof. Applied Art.*
 *M. Katherine Howells, B. S., *Instr. Household Sci.*
 †Bertha Huber, B. S., *Clothing Specialist.*
 †Julia L. Hurd, M. A., *Prof. Home Econ.*¹
 †Florence Imlay, B. S., *Milk Utilization Specialist.*
 *Lydia O. Jacobson, M. S., *Instr. Teacher Training.*
 *Elizabeth Johnson, B. S., *Instr. Applied Art.*
 †Mrs. Alma H. Jones, B. S., *Foods and Nutr. Specialist.*
 *Wilma B. Keyes, *Instr. Applied Art.*
 *Mrs. Daisy H. Kilgore, Ph. B., *Instr. Teacher Training.*
 *Lillis Knappenberger, Ph. B., *Assoc. Prof. Household Art.*
 *Mrs. Lulu R. Lancaster, *Asst. Prof. Household Mgt.*
 *Ruth M. Lindquist, M. A., *Asst. Prof. Household Mgt.*
 †Gertrude I. Lynn, M. S., *Home Mgt. Specialist.*
 *Macfred C. McKenzie, Ph. B., *Instr. Household Art.*
 *Lucy G. Magec, M. A., *Asst. Prof. Household Sci.*
 *Willetta Moore, B. S., *Instr. Household Sci.*
 *P. Mabel Nelson, Ph. D., *Assoc. Prof. Nutr.*
 †Elsie Richardson, B. S., *Home Furnishing Specialist.*
 *Mabel B. Richardson, *Instr. Applied Art.*
 *Alma Riemenschneider, B. S., *Asst. Prof. Household, Sci.*

¹ Noncollegiate course.**Home Economics—Continued.**

- *Anna G. Riggs, M. S., *Instr. Household Sci.*
 †Marie Roberts, B. S., *Clothing Specialist.*
 †Mabel Rockhill, B. S., *Clothing Specialist.*
 *Mabel Russell, B. S., *Asst. Prof. Applied Art.*
 *Emma L. Samuels, B. S., *Instr. Home Econ.*¹
 *Anna M. Sattler, B. S., *Instr. Household Art.*
 *Olive Settle, B. S., *Asst. Prof. Household Art.*
 *Ida M. Shilling, M. A., *Asst. Prof. Household Sci.*
 †Allie M. Smith, M. S., *Ext. Prof. Home Econ.*
 *Ruth Spencer, M. S., *Instr. Applied Art.*
 *Marie Stephens, B. S., *Asst. Prof. Household Art.*
 †Dorothy M. Taylor, M. S., *Foods and Nutr. Specialist.*
 *Marcia E. Turner, M. A., *Assoc. Prof. Teacher Training.*

Horticulture and Forestry: *†B. S. Pickett, M. S., *Head of Dept.; Chief Hort.*

- *†G. B. MacDonald, M. F.; *Prof. For.; Chief in For.*
 *†P. H. Elwood, jr., B. S., *Prof. Landsc. Arch.; Chief in Landsc. Arch.*
 †A. T. Erwin, M. S., *Chief in Truck Crops.*
 †T. J. Maney, B. S., *Chief in Pomol.*
 †I. T. Bode, M. S., *Ext. Assoc. Prof. For.*
 *M. E. Bottomley, M. L. D., *Instr. Landsc. Arch.*
 †W. C. Calvert, M. S., *Asst. Chief in Truck Crops.*
 *Perkins Coville, M. F., *Instr. For.*
 *J. C. Cunningham, B. S., *Prof. Hort., Bot., Chair. of Noncollegiate Courses.*
 †C. H. Diggs, *Landsc. Architect.*
 †C. L. Fitch, M. A., *Ext. Prof. Veg. Gard.*
 *E. S. Haber, M. S., *Asst. Prof. Hort.*¹
 †C. S. Holland, B. S., *Ext. Asst. in Pomol.*
 †C. V. Holsinger, B. S., *Ext. Prof. Hort.*
 *D. S. Jeffers, M. F., *Assoc. Prof. For.*
 †H. L. Lantz, M. S., *Asst. Chief in Pomol.*
 †H. E. Nichols, B. S., *Ext. Assoc. Prof. Hort.*
 †H. H. Plagge, M. S., *Asst. Pomol.*
 *H. W. Richey, B. S., *Prof. Pomol.*
 *R. R. Rothacker, B. S., *Instr. Hort.*¹
 *J. C. Schilleter, M. S., *Instr. Hort.*
 *E. C. Volz, M. S., *Assoc. Prof. Flor. and Veg. Gard.*
 *W. B. Ward, B. S., *Asst. Prof. Hort.*

Journalism (Agr.): *†F. W. Beckman, Ph. B., *Prof. Agr. Journalism; Bul. Editor.*

- †Mrs. Olive S. Alcox, *Asst. Bul. Editor.*
 *Blair Converse, M. A., *Asst. Prof. Agr. Journalism.*

†E. H. Richardson, *Photog.*†C. E. Roach, B. S., *Ext. Prof. Visual Instruction.**C. R. Smith, B. S., *Instr. Agr. Journalism.***Physics:** *L. B. Spinney, B. M. E., B. S. E. E., *Head of Dept.**A. A. Benedict, A. M., *Asst. Prof. Phys.**L. W. Butler, A. B., *Asst. Prof. Phys.**L. V. Crum, M. S., *Instr. Phys.**G. E. Davis, M. S., *Instr. Phys.**V. E. Heaton, A. M., *Instr. Phys.**William Kunerth, Ph. D., *Assoc. Prof. Phys.**H. J. Plagge, M. A., *Assoc. Prof. Phys.*

Physies—Continued.

- *D. M. Smith, B. S., *Instr. Phys.*
 *Harold Stiles, Ph. D., *Assoc. Prof. Phys.*
 *G. E. Thompson, Ph. D., *Assoc. Prof. Phys.*
 *L. H. Willson, B. S., *Asst. Prof. Phys.*
 *J. W. Woodrow, Ph. D., *Prof. Phys.*

Veterinary Medicine: *C. H. Stange, D. V. M.,
Dean of Div. and Dir. Vet. Invest.

- *H. E. Bemis, D. V. M., *Vice Dean of Div. and Head of Vet. Surg.*
 *E. A. Benbrook, V. M. D., *Head Vet. Path. Dept.*
 *H. D. Bergman, D. V. M., *Head Vet. Physiol. and Pharmacol. Dept.*
 *H. S. Murphey, D. V. M., *Head Vet. Anat. and Histol. Dept.*
 *Charles Murray, D. V. M., B. S., *Head Vet. Invest. Dept.*
 *W. A. Aitken, D. V. M., *Asst. Prof. Vet. Anat.*
 *†H. E. Biester, V. M. D., *Assoc. in Vet. Research.*
 *C. H. Covault, D. V. M., *Assoc. Prof. Vet. Med.*
 *H. H. Dukes, D. V. M., M. S., *Instr. Vet. Physiol.*
 *W. F. Guard, D. V. M., *Assoc. Prof. Vet. Surg.*
 *George Judisch, Phar. D., *Instr. Vet. Pharmacol.*

Veterinary Medicine—Continued.

- *G. W. McNutt, D. V. M., *Instr. Vet. Anat.*
 *S. H. McNutt, D. V. M., *Asst. Prof. Vet. Invest.*
 *C. D. Rice, B. S., D. V. M., *Assoc. Prof. Vet. Path.*
 †K. W. Stouder, D. V. M., *Ext. Prof. Vet. Med.*
 *F. E. Walsh, D. V. M., *Asst. Prof. Vet. Med.*
Zoology and Entomology: *†C. J. Drake,
Ph. D., Head of Dept.; Chief Ent. (State Ent.).
 *F. M. Baldwin, Ph. D., *Prof. Physiol.*
 †F. D. Butcher, A. B., *Ext. Ent.*
 †L. E. Dills, *Ext. Asst. in Apiary Work.*
 *†F. A. Fenton, Ph. D., *Assoc. Prof. and Assoc. Chief Ent.*
 *J. E. Guthrie, M. S., *Prof. Zool.*
 *†B. M. Harrison, M. S., *Instr. and Asst. in Apiculture.*
 *Sara Hoke, B. S., *Instr. Zool.*
 *H. S. Hopkins, Ph. D., *Asst. Prof. Physiol.*
 *J. G. Jessup, B. S., *Instr. Apiculture.*¹
 †Henry Ness, B. S., *Asst. State Ent.*
 *†F. B. Paddock, M. S., *Assoc. Prof. Apiculture; Apiculturist (State Apiarist).*
 †R. L. Parker, M. S., *Asst. Chief in Apiculture.*
 *I. L. Ressler, M. S., *Instr. Zool.*
 *W. H. Wellhouse, Ph. D., *Assoc. Prof. Ent.*
 †A. D. Worthington, *Ext. Asst. in Apiculture.*

KANSAS.

Kansas State Agricultural College and the Agricultural Experiment Station, Manhattan.

*College faculty. †Station staff. ‡Extension staff.

- *W. M. Jardine, B. S. A., LL. D., *President.*
 *†F. D. Farrell, B. S., *Dean Div. of Agr., Dir. of Sta.*
 †H. J. C. Umberger, B. S., *Dean and Dir. Div. of Ext.*
 R. A. Seaton, M. S., *Dean Div. of Engin., Dir. Engin. Expt. Sta.*

Agronomy: *†L. E. Call, M. S., *Head Dept. of Agron.*

- *†C. O. Swanson, Ph. D., *Head Dept. of Milling Indus.*
 *C. D. Davis, B. S., *Asst. Prof. Farm Crops.*
 *H. R. Guilbert, B. S., *Instr. Agr.*
 †Mrs. Elizabeth P. Harling, *Seed Analyst.*
 *†L. K. Landon, B. S., *Asst. Prof. Agron.; in charge S.E. Field Stas.*
 *†H. H. Laude, M. S., *Assoc. Prof. Agron.; in charge Coop. Expts.*
 *†E. S. Lyons, B. S., *Asst. Prof. and Asst. in Soils.*
 †C. W. Oakes, *Miller.*
 *†J. H. Parker, M. S., *Prof. Farm Crops; Plant Brdg. (Coop. U. S. D. A.).*
 †G. H. Phinney, *Foreman of Agron. Farm.*
 *†S. C. Salmon, M. S., *Prof. and Asst. in Farm Crops.*
 †A. J. Schoth, B. S., *Instr. Farm and Garden Crops (Junior Work).*
 *†M. C. Sewell, Ph. D., *Assoc. Prof. and Asst. in Soils.*
 †H. R. Sumner, M. A., *Crop Specialist.*
 *†R. I. Throckmorton, M. S., *Prof. and Asst. in Soils.*
 †E. B. Wells, M. S., *Soils Specialist.*

¹ Noncollegiate course.

Agronomy—Continued.

- †L. E. Willoughby, B. S., *Farm Crops Specialist.*
 *†E. B. Working, Ph. D., *Assoc. Prof. and Assoc. in Milling Indus.*
 *†J. W. Zahnley, B. S., *Assoc. Prof. and Assoc. in Farm Crops.*
Animal Industry: *†C. W. McCampbell, B. S.,
D. V. M., Head Dept. of An. Husb.
 *†J. B. Fitch, B. S., *Head Dept. of Dairy Husb.*
 *†L. F. Payne, B. S., *Head Dept. of Poultry Husb.*
 *†B. M. Anderson, B. S., *Asst. Prof. An. Husb.; Horse Invest.*
 *C. E. Aubel, M. S., *Asst. Prof. An. Husb.*
 *†F. W. Bell, B. S., *Prof. An. Husb.; Swine Invest.*
 *†H. W. Cave, M. S., *Assoc. Prof. Dairy Husb.; Dairy Prod.*
 †M. H. Coe, B. S., *Instr. Junior An. Husb.*
 †C. G. Elling, B. S., *An. Husb. Specialist.*
 †O. J. Gould, B. S., *Deputy State Dairy Comr.*
 *†H. L. Ibsen, Ph. D., *Assoc. Prof. An. Husb.; An. Brdg. Invest.*
 †H. M. Jones, B. S., *State Dairy Comr.*
 †R. W. Kiser, B. S., *An. Husb. Specialist.*
 †A. W. Knott, B. S., *Dairy Husb. Specialist.*
 *†R. H. Lush, M. S., *Instr. and Asst. in Dairy Husb.*

Animal Industry—Continued.

- *†P. C. McGilliard, B. S., *Instr. Dairy Husb.; in charge Official Tests.*
 †J. H. McAdams, *Poultry Husb. Specialist.*
 *†D. L. Mackintosh, B. S., *Asst. Prof. and Asst. An. Husb.*
 *†H. W. Marston, M. S., *Instr. and Asst. An. Husb.*
 †H. B. Mugglestone, *Supt. Poultry Plant.*
 †Charles Nitcher, B. S., *Instr. An. Husb. Ext.*
 *†N. E. Olson, B. S., *Assoc. Prof. Dairy Husb.; Dairy Mfrs.*
 *†H. E. Reed, B. S., *Prof. An. Husb.; Sheep Invest.*
 *K. M. Renner, B. S., *Asst. in Dairy Husb.*
 *H. H. Steup, B. S., *Instr. Poultry Husb.*
 †D. J. Taylor, B. S., *Poultry Husb. Specialist.*
 †L. W. Taylor, B. S., *Poultry Specialist.*
 *†D. C. Warren, Ph. D., *Assoc. Prof. Poultry Husb.; Poultry Brdg.*
 *†A. D. Weber, B. S., *Instr. and Asst. An. Husb.*

Bacteriology: *†L. D. Bushnell, Ph. D., *Head of Dept.*

- *F. S. Davenport, B. S., *Asst. in Soil Bact.*
 *†A. C. Fay, M. S., *Instr. Dairy Bact.; Dairy Bact.*
 *†P. L. Gainey, M. S., *Assoc. Prof. Bact.; Soil Bact.*
 *†W. R. Hinshaw, D. V. M., *Instr. Bact.; Poultry Disease Invest.*

Botany and Plant Pathology: *†L. E. Melchers, M. S., *Head of Dept.*

- *†E. C. Miller, Ph. D., *Prof. Plant Physiol.; Plant Physiol.*
 *Dorothy J. Cashen, M. S., *Instr. Bot.*
 *Nora E. Dalbey, A. M., *Instr. Bot.*
 *W. E. Davis, A. B., *Assoc. Prof. Bot.*
 *F. C. Gates, Ph. D., *Assoc. Prof. Bot.*
 *H. H. Haymaker, M. S., *Asst. Prof. Bot.*
 †C. O. Johnston, B. S., *Asst. in Cereal Diseases (Coop. U. S. D. A.).*
 †E. M. Stokdyk, M. S., *Plant Path. Specialist.*
 *†R. P. White, B. S., *Instr. Bot.; Asst. in Plant Path.*

Chemistry: *†H. H. King, Ph. D., *Head of Dept.*

- *†J. S. Hughes, Ph. D., *Prof. Chem.; An. Nutr.*
 *†J. T. Willard, D. Sc., *Consult. Chem. Vice Pres. of Coll.*
 *H. W. Brubaker, Ph. D., *Assoc. Prof. Chem.*
 *Esther Bruner, M. S., *Instr. Chem.*
 *C. W. Colver, Ph. D., *Assoc. Prof. Chem.*
 †H. R. De Rose, A. B., *Assoc. in Food Anat.*
 *Stella M. Harriss, M. S., *Instr. Chem.*
 *S. B. Hendricks, M. S., *Instr. Chem.*
 †J. C. Jenkins, M. S., *Instr. Chem.*
 *G. H. Joseph, M. S., *Instr. Chem.*
 *E. B. Keith, B. S., *Instr. Chem.*
 *George Kuerner, M. S., *Instr. Chem.*
 *†W. L. Latshaw, M. S., *Asst. Prof. Chem.; Soil, Feeding-stuffs, and Fert. Anal.*
 †J. F. Merrill, B. S., *Asst. Chem.*
 *†W. H. Moran, Ph. D., *Asst. Prof. and Asst. Chem.*
 *†E. Sellers, B. S., *Instr. Chem.*
 *†E. L. Tague, M. S., *Assoc. Prof. Chem.; Protein Invest.*
 †R. W. Titus, A. M., *Assoc. in Feeding-stuffs Anal.*

† On leave.

‡ For subject-matter workers see the respective division, i. e., agronomy, animal industry, etc.

Chemistry—Continued.

*G. B. Watkins, B. S., *Instr. Chem.*

Economics (Agr.): *†W. E. Grimes, Ph. D., *Head of Dept.*

- *W. H. Burr, B. S., *Prof. Sociol.*
 †I. N. Chapman, B. S., *Farm Mgt. Dem.*
 *†Eric Englund, M. S., *Prof. Agr. Econ.; Land Econ.*
 *†Morris Evans, B. S., *Instr. Agr. Econ.; Farm Organ.*
 *†R. M. Green, B. S., *Assoc. Prof. Agr. Econ.; Asst. in Marketing Invest.*
 †H. J. Henney, B. S., *Research Asst. in Agr. Econ.*
 *J. A. Hodges M. S., *Instr. Agr. Econ.*
 †J. H. Moyer, B. S., *Research Asst. in Agr. Econ. (P. O., Holton).*
 †R. D. Nichols, B. S., *Research Asst. in Agr. Econ. (P. O., McPherson).*

Education (Agr.): *E. L. Holton, A. B., *Head of Dept.*

- ‡G. A. Gemmill, M. S., *Prof. Ed. in charge Home Study Service.*
 †P. P. Brainard, A. M., *Assoc. Prof. Ed.*
 *A. P. Davidson, B. S., *Prin. Voc. School.*
 †B. H. Fleenor, M. S., *Asst. Prof. Ed., Home Study Service.*
 *C. V. Williams, M. S., *Prof. Voc. Ed.*

Engineering (Agr.): *H. B. Walker, C. E., *Head of Dept.*

- ‡Mark Havenhill, B. S. A. E., *Prof. in charge Rural Ext. Engin.*
 *R. H. Driftmier, B. S. A. E., *Asst. Prof. Agr. Engin.*
 *V. R. Hillman, B. S. A. E., *Asst. Prof. Agr. Engin.*
 †Floyd Pattison, B. S. M. E., *Assoc. Prof. Rural Engin., Home Study Service.*
 *W. H. Sanders, M. E., *Assoc. Prof. Agr. Engin.*
 *B. B. Smith, *Asst. in Agr. Engin.*
 †W. G. Ward, B. S., *Assoc. Prof. Rural Arch.*

Entomology: *†G. A. Dean,¹ M. S., *Head of Dept.*

- *†J. W. McColloch, M. S., *Assoc. Prof. Ent.; Staple Crop Insect Invest. Actg. Head of Dept.*
 *†W. P. Hayes, Ph. D., *Asst. Prof. and Asst. Ent.*
 †E. G. Kelly, M. S., *Ent. Specialist.*
 *†J. H. Merrill, Ph. D., *Assoc. Prof. Ent.; Asst. in Fruit Insect Invest. (State Apiarist).*
 †A. E. Oman, M. F., *Rodent Control Specialist (Coop. U. S. D. A.).*
 *†R. C. Smith, Ph. D., *Assoc. Prof. Ent.; Staple Crop Insect Invest.*

Extension (Admin.):² Dean and Director Umberger in charge.

- †Amy Kelly, B. S., *State Home Dem. Leader.*
 †R. W. Morrish, B. S., *State Club Leader.*
 †Ellen M. Batchelor, B. S., *Asst. State Home Dem. Leader.*
 †Delpha M. Hazeltine, *Asst. to the Dean and Dir.*
 †Eleanor Howe, B. S., *Asst. State Club Leader.*
 †Samuel Pickard, B. S., *in charge Information.*

Home Economics: *Margaret M. Justin, Ph. D., *Dean of Div.*

- *Louise P. Glanton, A. M., *Head Dept. of Clothing and Textiles.*

Home Economics—Continued.

- *Araminta Holman, B. S., *Head Dept. of Applied Art.*
 *Amy-Jane Leazenby, A. M., *Head Dept. of Household Econ.*
 *Martha S. Pittman, A. M., *Head Dept. of Food Econ. and Nutr.*
 †Harriet W. Allard, B. S., *Home Econ. Specialist.*
 *Ethel M. Arnold, B. S., *Asst. in Applied Art.*
 *Mina Bates, Ph. B., *Instr. Food Econ. and Nutr.*
 *Emily Bennett, B. S., *Instr. Food Econ. and Nutr.*
 *Helen A. Bishop, A. M., *Asst. Prof. Household Econ.*
 *Effie M. Carp, A. M., *Asst. Prof. Household Econ.*
 *Florence R. Clarke, A. B., *Instr. Clothing and Textiles.*
 *Ina F. Cowles, B. S., *Assoc. Prof. Clothing and Textiles.*
 *Jean S. Dobbs, B. S., *Asst. Prof. Household Econ.*
 *Vinnie Drake, B. S., *Asst. in Household Econ.*
 †Margaret Dubbs, B. S., *Instr. Home Econ., Home Study Service.*
 *Louise H. Everhardy, *Instr. Applied Art.*
 *Emma F. Fecht, *Instr. Clothing and Textiles.*
 †L. Maude Finley, B. S., *Specialist in Clothing and Textiles.*
 *Katherine Hudson, M. S., *Asst. Prof. Food Econ. and Nutr.*
 *Martha M. Kramer, Ph. D., *Assoc. Prof. Food Econ. and Nutr.*
 †W. Pearl Martin, R. N., *Home Nursing Specialist.*
 *Mary E. Polson, B. S., *Instr. Clothing and Textiles.*
 *Pearle E. Ruby, M. S., *Assoc. Prof. Food Econ. and Nutr.*
 †Minnie Sequist, A. B., *Specialist in Clothing and Textiles.*
 †Luella P. Sherman, B. S., *Nutr. Specialist.*
 *Mary A. Worcester, B. S., *Instr. Clothing and Textiles.*
- Horticulture:** *†Albert Dickens, M. S., *Head of Dept.*
 *†R. J. Barnett, M. S., *Prof. Hort.: Pomol.*
 *†W. B. Balch, B. S., *Asst. Prof. Hort.: Greenhouse Foreman.*
 *†W. F. Pickett, M. S., *Asst. Prof. Hort.: Orchard Invest.*
 *W. S. Wiedorn, B. S., M. L. D., *Asst. Prof. Landsc. Gard.*
 †L. C. Williams, B. S., *Hort. Specialist.*
 †J. C. Wingfield, B. S., *Instr. Hort., Home Study Service.*

Illustrations: *†F. E. Colburn, *Head of Dept. Prof. Photog.*

Journalism: *C. E. Rogers, B. A., *Assoc. Prof. Agr. Journalism.*

Physics: *J. O. Hamilton, B. S., *Head of Dept.*

*G. E. Raburn, M. S., *Prof. Phys.*

Veterinary Medicine: *†R. R. Dykstra, D. V. M., *Dean of Div.; Vet.*

*J. H. Burt, D. V. M., *Head Dept. of Anat. and Physiol.*

*†H. F. Lienhardt, D. V. M., *Head Dept. of Vet. Path.*

*J. F. Bullard, D. V. M., *Instr. Vet. Med.*

*E. J. Frick, D. V. M., *Assoc. Prof. Vet. Med.*

†N. D. Harwood, D. V. M., *Asst. in Vaccine Labs.*

†C. W. Hobbs, D. V. S., *Field Vet. and Supt. Vaccine Labs.*

*†C. H. Kitselman, V. M. D., *Asst. Prof. Path.; Abortion Disease Invest.*

*W. M. McLeod, D. V. M., *Assoc. Prof. Physiol. and Anat.*

*†C. E. Sawyer, D. V. M., *Instr. Vet. Path.; Asst. Path.*

*†J. P. Scott, D. V. M., *Assoc. Prof. An. Path.; Blackleg Invest.*

Zoology: *†R. K. Nabours, Ph. D., *Head of Dept.*

*†J. E. Ackert, Ph. D., *Prof. Zool.; Parasitol.*

*†F. E. Emery, D. V. M., *Asst. Zool.; Asst. Mammalogist.*

*C. A. Gunns, *Instr. Zool.*

*Mary T. Harman, Ph. D., *Prof. Zool.*

*†F. L. Hisaw, M. A., *Asst. Prof. Zool.; Mammalogist.*

†Caroline M. Perkins, A. B., *Asst. in Genetics.*

*A. B. Sperry, B. S., *Instr. Zool.*

Miscellaneous:

*†Hugh Durham, A. M., *Asst. to Dean of Agr.*

*A. B. Smith, B. L. S., *Libr.*

Substations:

Colby—B. F. Barnes, B. S., *Supt. (Coop. U. S. D. A.).*

Fort Hays, P. O., *Hays—*

L. C. Aicher, B. S., *Supt.*

R. E. Getty, B. S., *Forage Crops (Coop. U. S. D. A.).*

A. L. Hallsted, B. S., *Dry Farming (Coop. U. S. D. A.).*

A. H. Kerns, *Asst. to Supt.*

A. F. Swanson, M. S., *Cereal Invest. (Coop. U. S. D. A.).*

Garden City—

F. A. Wagner, B. S., *Supt.*

E. H. Coles, B. S., *Dry Land Agr. (Coop. U. S. D. A.).*

Tribune—G. E. Lowrey, *Supt.*

KENTUCKY.

College of Agriculture and the Agricultural Experiment Station of the University of Kentucky,
Lexington.

*College faculty. †Station staff. ‡Extension staff.

*F. L. McVey, Ph. D., LL. D., *President of University.*

*††T. P. Cooper, B. S. in A., *Dean Coll. of Agr., Dir. of Sta., Dir. of Ext. Service.*
F. P. Anderson, M. E., *Dean Coll. of Engin.*

Agronomy: *††George Roberts, M. S., *Head of Dept. Asst. Dean of Coll.*

*†E. N. Fergus, M. S., *Asst. Prof. Farm Crops; Asst. Agron.*

†J. F. Freeman, M. S., *Supt. of Expt. Fields.*

†E. M. Johnson, M. S., *Asst. Agron.*

†S. C. Jones, M. S., *Field Agt. in Agron.*

*†P. E. Karraker, M. A., *Assoc. Prof. Soils; Asst. Agron.*

†Ralph Kenney, B. S., *Field Agt. in Agron.*

*†E. J. Kinney, B. S., *Prof. Farm Crops; Assoc. Agron.*

*†W. D. Valleau, Ph. D., *Assoc. Prof. Plant Path.; Plant Path.*

Animal Industry: *††E. S. Good, M. S., *Chair. An. Indus. Group.*

*†J. J. Hooper, M. S., *Prof. Dairy Husb.; in charge Dairy Invest.*

*††Jos. H. Martin, B. S., *Assoc. Prof. and in charge Poultry Husb.*

*††W. S. Anderson, M. A., *Prof. Genetics; in charge Horse Husb.*

*†J. O. Barkman, B. S., *Asst. Prof. Dairy Mfrs. and Field Agt. in Dairying.*

†J. M. Door, B. S. *Insp. of Creameries.*

*†J. D. Foster, M. S., *Instr. An. Husb.; Insp. in charge Creameries.*

†Amanda H. Harms, B. S., *Asst. Pathogenic Bact. in An. Husb.*

†C. E. Harris, B. S., *Field Agt. in Poultry Husb.*

*†W. J. Harris, B. S., *Asst. Prof. and Asst. An. Husb.*

*††L. J. Horlacher, M. S., *Assoc. Prof. and Asst. An. Husb.*

†J. E. Humphrey, B. S., *Field Agt. in Poultry Husb.*

†H. R. Jackson, B. S., *Field Agt. in Poultry Husb.*

†R. C. Miller, M. S., *Field Agt. in An. Husb.*

†J. W. Nutter, *Supt. Dairy Farm.*

†E. M. Prewitt, B. S., *Field Agt. in Dairying.*

†Wayland Rhoads, M. S., *Field Agt. in An. Husb.*

†H. G. Sellards, B. S., *Field Agt. in An. Husb.*

†J. R. Smyth, B. S., *Field Agt. in Poultry Husb.*

*†E. J. Wilford, B. S., *Assoc. Prof. and Asst. An. Husb.*

*†W. W. Dimock, D. V. M., *Prof. and Head Dept. of Vet. Sci.*

†E. A. Caslick, D. V. M., *Asst. in Vet. Sci.*

††T. P. Polk, D. V. M., *Field Agt. in Vet. Sci.*

†D. A. Sanders, D. V. M., *Asst. in Vet. Sci.*

†Ethel M. Snyder, B. S., *Lab. Asst. in Vet. Sci.*

*†A. J. Steiner, D. V. M., *Instr. Vet. Sci.; Asst. Vet.*

Chemistry: *†A. M. Peter, D. Sc., *Head of Dept. Prof. Soil Tech.*

†S. D. Averitt, M. S., *Chem.*

†G. D. Buckner, Ph. D., *Research Chem.*

*†D. J. Healy, M. D. C. M., *Prof. Agr. Bact.; Research Bact.*

†W. D. Iler, *Asst. Chem.*

†J. S. McHargue, Ph. D., *Research Chem.*

†O. M. Shedd, M. S., *Research Chem.*

Economics (Agr.): *††W. D. Nicholls, M. S., *Head Dept. of Farm Econ.*

*††O. B. Jesness, B. S., *Prof. Marketing; Chief Sec. of Markets.*

††D. G. Card, B. S., *Asst. and Field Agt. in Marketing.*

†Z. L. Galloway, B. S., *Field Agt. in Farm Mgt.*

*†J. B. Hutson, B. S., *Asst. Prof. and Asst. in Farm Mgt.*

†J. W. Jones, M. A., *Field Agt. in Marketing.*

†E. L. Langford, B. S., *Asst. in Farm Mgt. (Coop. U. S. D. A.).*

†J. C. Melvin, B. S., *Asst. in Farm Mgt. (Coop. U. S. D. A.).*

†E. C. Vaughn, A. B., *Asst. in Marketing (Coop. U. S. D. A.).*

Engineering (Agr.): *†J. B. Kelley, B. S. (M. E., A. E.), *Prof. Agr. Engin.*

†E. G. Welch, B. S. A. E., *Field Agt. in Agr. Engin.*

Entomology and Botany: *†Harrison Garman, D. Sc., *Head of Dept. Prof. Ent.*

†Mary LeG. Didlake, M. S., *Asst. Ent. and Bot.*

†Carrie L. Hathaway, *Seed Analyst.*

†Marie Jackson, *Seed Analyst.*

†H. H. Jewett, M. A., *Research Asst. in Ent. and Bot.*

†R. A. Stevenson, B. S., *Insp. Ent. and Bot. Dept.*

†Jessie Terry, *Seed Analyst.*

Extension (Admin.): † Director Cooper *in charge.*

†T. R. Bryant, B. S., *Asst. Dir.*

†C. A. Mahan, M. S., *State Agt.*

†J. W. Whitehouse, M. S., *State Club Agt.*

†Anita Burnam, B. S., *Field Agt. in Club Work.*

†N. R. Elliott, B. S., *Asst. State Agt.*

†J. M. Feltner, *Field Agt. in Club Work.*

†E. E. Fish, M. S., *Field Agt. in Club Work.*

†M. S. Garside, B. S., *Field Agt. in Club Work.*

†Mrs. Margaret D. Jonas, *Asst. State Home Dem. Agt.*

†E. J. Kilpatrick, B. S., *Asst. State Agt.*

†Lulie E. Logan, A. B., *Asst. State Home Dem. Agt.*

†Garnett McKenney, B. S., *Field Agt. in Club Work.*

† For subject-matter workers see the respective division, i. e., agronomy, animal industry, etc.

Extension (Admin.)—Continued.†B. G. Nelson, *Asst. State Agt.***Home Economics:** *†Mary E. Sweeny, M. A.,
*Chair. of Group, Prof. Home Econ.**L. Maybelle Cornell, S. B., *Prof. Home Econ.*†Katharine B. Christian, B. S., *Field Agt. in Home Econ.**Marietta Eichelberger, S. M., *Prof. Home Econ.*†Eleanor M. Enright, B. S., *Field Agt. in Home Econ.**Nellie Fitzgerald, M. A., *Instr. Home Econ.*†Nellie A. Gard, M. A., *Field Agt. in Home Econ.**Minnie M. Kennedy, M. A., *Instr. Home Econ.**Lilly Kahl, M. S., *Instr. Institutional Mgt.*†Mary M. Miller, B. S., *Field Agt. in Home Econ.*†Irene M. Piedalue, B. S., *Field Agt. in Home Econ.***Horticulture:** *†C. W. Mathews, B. S., *Head of Dept.*†J. S. Gardner, M. A., *Field Agt. in Hort.***The Kentucky Normal and Industrial Institute for Colored Persons, Frankfort.**

*Agricultural faculty.

*G. P. Russell, A. B., LL. D., *President.**M. Belle Anderson, *Dir. of Practice House.**W. D. Black, *First Asst. in Agr.**J. H. Lyons, *Engin.**Ruby H. Martin, *Dom. Art.**Zulema B. Patton, B. S., *Instr. Dom. Sci.**W. L. Shobe, A. B., *Farm Crops.***Horticulture**—Continued.†W. W. Magill, B. S., *Field Agt. in Hort.**†A. J. Olney, M. H., *Prof. Hort.; Asst. Hort.***Public Service Labs:** †L. A. Brown, *Phar. D., Director.*†E. J. Gott, B. S., *Bact.*†Ethel L. Hoppman, B. S., *Serologist.*†James H. Martin, Ph. G., *Asst. Chem.*†A. L. Meader, B. A., *Asst. Chem.*†W. J. Nungester, M. S., *Asst. Bact.***Regulatory Work:** †J. D. Turner, LL. B., *Head Feed Control Dept.*†H. E. Curtis, M. S., *Head Fert. Control Dept.*†H. R. Allen, M. A., *Chem. in Fert. Control.*†Fred Fitschen, *Insp. in Feed Control.*†Lelah Gault, B. S., *Asst. Chem. in Fert. Control.*†R. W. Jones, *Insp. in Fert. Control.*†H. D. Spears, M. S., *Chem. in Feed Control.*†W. G. Terrell, *Insp. in Feed Control.***Miscellaneous:**†Grace L. Snodgrass, *Libr.*†W. S. Smith, B. S., *Asst. Editor.***LOUISIANA.****The Louisiana State University and Agricultural and Mechanical College and the State Experiment Station, University Station, Baton Rouge; the Sugar Station, Baton Rouge; the North Louisiana Station, Calhoun; the Rice Station, Crowley; and the Fruit and Truck Station, Hammond.**

*College faculty. †Station staff. ‡Extension staff.

*T. D. Boyd, A. M., LL. D., *President.**†W. R. Dodson, B. S., A. B., *Dean Coll. of Agr., Dir. of Stations.*†W. R. Perkins, M. S., *Dir. Agr. Ext. Dept.*T. W. Atkinson, B. S., C. E., *Dean Coll. of Engin.***Agronomy:** *W. R. Hendrix, B. S., *Prof. Agron.*†E. K. Breeden, *Farm Mgr.**W. B. Cobb, M. A., *Assoc. Prof. Agron.**F. D. Stevens, B. S., *Prof. Farm Mgt. (Coop. U. S. D. A.).***Animal Industry:** *E. L. Jordan, B. S., *Prof. An. Indus.**R. C. Calloway, B. S., *in charge Dairying.*†G. L. Burleson, B. S., *Swine Specialist.*†C. C. Chapman, *Beef Cattle Specialist.**J. B. Francioni, B. S., *Asst. Prof. An. Husb.*†L. E. Morgan, *Livestock, and Tick Erad. Specialist.*†E. W. Neasham, B. S., *Dairy Specialist.**C. H. Staples, B. S., *Prof. Dairying.*†H. L. Williams, *Poultry Specialist.*†Elsmer Wilson, B. S., *Poultry Clubs.***Botany:** *†C. W. Edgerton, Ph. D., *Instr. Plant Path.; Plant Path.*†C. C. Moreland, B. S., *Asst. Plant Path.**C. F. Moreland, M. S., *Asst. Prof. Bot.**B. W. Lafene, B. S., *Instr. Bact.***Chemistry:** †A. P. Kerr, M. S., *Chief Chem.**C. E. Coates, Ph. D., *Prof. Chem., Dean of Sugar School.*†D. N. Barrow, B. S., *Specialist in Sugar Cane Work.*†W. P. Denson, B. S., *Asst. Chem.*†J. L. Farr, M. S., *Asst. Chem.**P. M. Horton, B. S., *Asst. Prof. Chem.*†J. H. Jolly, B. S., *Asst. Chem.**R. L. Menville, M. S., *Assoc. Prof. Chem.**F. J. Robichaux, B. A., *Instr. Chem.***Economics (Agr.):** †A. G. Hamilton, B. S., *Agt. in Marketing.*†Mrs. Mary B. Giesen, *Specialist in Women's Organ. Work.*†F. W. Spencer, B. S., *Specialist in Organ. Work.***Editorial and Publicity:** *†M. G. Osborn, B. A., *Assoc. Prof. Journalism, Editor.*†Marjorie B. Arbour, B. S., *Asst. Editor.*†B. B. Mackey, *Asst. Editor.***Education (Agr.):** *J. G. Lee, jr., B. S., *Director.*

Engineering (Agr.): *E. B. Doran, B. S., *Prof. Farm Mech.*

*C. R. Neff, B. S., *Instr. Farm Mech.*

Extension (Admin.): † Director Perkins *in charge and State Agt.*

‡W. B. Mercier, B. S., *Asst. Dir.*

‡Norma Overbey, B. S., *State Home Dem. Agt.*

‡W. C. Abbott, M. S., *State Club Agt.*

‡C. B. Haddon, B. S., *Asst. State Agt. (Plan Clubs).*

‡M. M. La Croix, B. S., *Asst. State Agt. (An. Clubs).*

‡L. E. Perrin, *Asst. State Agt.*

Home Economics: *Mattie R. Sebastian, M. A., *Director.*

*Rosamond H. Kedzie, B. S., *Prof. Home Econ.*

*Mrs. W. W. Nuckols, M. A., *Instr. Home Econ.*

‡Mary E. Thomas, *Dairying, Foods, and Nutr. Specialist.*

Horticulture and Forestry: *J. G. Lee, B. S., *Prof. Hort., For.*

‡‡G. L. Tiebout, B. S., *Hort.*

‡Montford Hull, *Sweet Potato Specialist.*

‡H. C. Smith, B. S., *Garden Specialist.*

Physics: *D. V. Guthrie, Ph. D., *Prof. Phys.*

*R. C. Keen, B. S., *Instr. Phys.*

Veterinary Science: *†W. H. Dalrymple, M. R. C. V. S., *Prof. Vet. Sci.; Assoc. Dir. of Stas.*

*†Harry Morris, V. D. M., *Instr. Vet. Sci.; Vet. and Bact.*

Zoology and Entomology: *W. H. Gates, B. S., *Prof. Zool. and Ent.*

*†W. E. Hinds, Ph. D., *Prof. Ent.; Ent.*

*Ellinor H. Behre, Ph. D., *Asst. Prof. Zool.*

‡W. G. Bradley, B. S., *Asst. Ent.*

‡E. C. Davis, *Specialist in Bee Culture.*

*E. W. Dunnam, M. S., *Asst. Prof. Zool., Ent.*

*O. W. Rosewall, M. S., *Assoc. Prof. Ent.*

Miscellaneous:

*Annie M. Beale, *Libr.*

*†R. P. Swire, B. A., *Treas.*

Branch Stations: W. R. Dodson, B. S., A. B., *Dir. of Stations.*

Fruit and Truck Sta., P. O., *Hammond—B. Szymoniak, B. S., Asst. Dir.*

North La. Sta., P. O., *Calhoun—Sydney Stewart, Farm Mgr.*

Rice Sta., P. O., *Crowley—J. M. Jenkins, B. S., Asst. Dir. (Coop. U. S. D. A.).*

Sugar Sta., P. O., *Baton Rouge—*

W. G. Taggart, B. S., *Asst. Dir.*

J. F. Brewster, Ph. D., *Research Chem.*

W. L. Owen, B. S., *Research Bact.*

Southern University and Agricultural and Mechanical College of the State of Louisiana, Scottlandville.

*Agricultural faculty. †Extension staff.

*J. S. Clark, A. M., Ph. D., *President.*

*L. C. Bowling, B. S., *Agr.*

*Beatrice Durham, *Sewing.*

*L. J. Gurst, *Agr.*

‡T. J. Jordan, *Ext. Agt. in Club Work.*

*Cornelius King, *Voc. Agr.*

*Mrs. Emma Maberry, *Cooking.*

*Ethel L. Mitchell, *Cooking.*

*J. H. Theus, *Agr.*

*Louise Walton, *Sewing.*

MAINE.

College of Agriculture and the Agricultural Experiment Station of the University of Maine Orono.

*College faculty. †Station staff. ‡Extension staff.

*C. C. Little, Sc. D., *President of University.*

*†L. S. Merrill, M. D., D. Sc., *Dean Coll. of Agr., Dir. Agr. Ext. Service.*

‡W. J. Morse, Ph. D., Sc. D., *Dir. of Sta.*

H. S. Boardman, C. E., D. Eng., *Dean Coll. of Tech.*

Agronomy: *G. E. Simmons, D. Sc., *Prof. Agron.*

‡A. K. Gardner, B. S., *Crops Specialist.*

*B. C. Helmick, M. S., *Asst. Prof. Agron.*

*H. C. Swift, M. S., *Instr. Agron.*

Animal Industry: *L. S. Corbett, M. S., *Prof. An. Indus.*

*L. M. Dorsey, M. S., *Assoc. Prof. An. Indus.*

*L. P. Gardner, M. S., *Asst. Prof. Poultry Husb.*

*H. W. Hall, B. S., *Instr. An. Indus.*

‡R. F. Talbot, B. S., *Dairy Specialist.*

‡O. M. Wilbur, M. S., *Poultry Specialist.*

Bacteriology: *F. L. Russell, B. S., V. S., *Prof. Bact. and Vet. Sci.*

*E. R. Hitchner, M. S., *Asst. Prof. Bact.*

Biology: * ———, *Prof. Biol.*

‡J. W. Gowen, Ph. D., *Biol.*

*C. H. Batchelder, M. S., *Assoc. Prof. Biol.*

*I. H. Blake, A. M., *Assoc. Prof. Biol.*

‡Mildred R. Covell, *Biol. Computer.*

‡Marjorie E. Gooch, M. S., *Asst. in Biol.*

*E. D. Hull, M. S., *Instr. Biol.*

‡Karl Sax, Sc. D., *Biol.*

‡H. B. Smith, M. S., *Asst. Biol.*

‡Emmeline D. Wilson, *Lab. Asst. in Biol.*

*Helen Woodbridge, M. S., *Instr. Biol.*

Chemistry: *L. H. Merrill, Sc. D., *Prof. Biological and Agr. Chem.*

‡J. M. Bartlett, M. S., *Chem.*

† For subject-matter workers see the respective division, i. e., agronomy, animal industry, etc.

Chemistry—Continued.

*H. W. Smith, M. S., *Asst. Prof. Biological and Agr. Chem.*

†E. R. Tobey, M. S., Ch. E., *Assoc. Chem.*

†C. H. White, Ph. C., *Asst. Chem.*

Education (Agr.): *H. S. Hill, A. B., *Prof. Agr. Ed.*

Entomology: †Edith M. Patch, Ph. D., *Ent.*

†Alice W. Averill, *Lab. Asst. Ent.*

Extension (Admin.): † Director Merrill in charge.

‡A. L. Deering, B. S., *County Agt. Leader.*

‡Rosalind M. Jewett, B. S., *State Home Dem. Leader.*

‡L. H. Shibles, A. B., *State Club Leader.*

‡M. D. Jones, B. S., *Farm Mgt. Dem.*

‡Arra S. Mixer, *Asst. State Club Leader.*

Forestry: *J. M. Briscoe, M. F., *Prof. For.*

*C. W. L. Chapman, M. S., *Asst. Prof. For.*

*D. B. Demeritt, M. F., *Instr. For.*

‡M. E. Watson, B. S., *For. Specialist.*

Home Economics: *Esther McGinnis, B. S., *Assoc. Prof. and Actg. Head of Dept.*

*Louise Bancroft, B. S., *Asst. Prof. Home Econ.*

‡Edna M. Cobb, *Home Econ. Specialist.*

*Pearl S. Greene, M. A., *Asst. Prof. Home Econ.*

‡M. Eleanor Jackson, B. S., *Home Econ. Specialist.*

*Florence J. Morrill, B. S., *Instr. Home Econ.*

Horticulture: *H. P. Sweetser, B. S., *Prof. Hort.*

*W. W. Wiggin, B. S., *Instr. Hort.*

Plant Pathology: †Donald Folsom, Ph. D., *Plant Path.*

†Reiner Bonde, B. S., *Asst. Plant Path.*

Substations:

Aroostook Farm, P. O., *Presque Isle—Perley Downing, Supt.*

Highmoor Farm, P. O., *Monmouth—Welling-ton Sinclair, Supt.*

MARYLAND.**College of Agriculture, Agricultural Experiment Station, and the Extension Service of the University of Maryland, College Park.**

*College faculty. †Station staff. ‡Extension staff.

*A. F. Woods, A. M., D. Agr., LL. D., *President of University.*

*P. W. Zimmerman, M. S., *Dean Coll. of Agr. Prof. Plant Physiol. and Ecology.*

†H. J. Patterson, D. Sc., *Dir. of Sta.*

‡T. B. Symons, M. S., D. Agr., *Dir. of Ext. Service.*

A. N. Johnson, S. B., *Dean Coll. of Engin.*

Agronomy: *†J. E. Metzger, B. S., *Prof. Agron.;*

Agron.

*G. F. Eppley, B. S., *Asst. Prof. Agron.*

*†W. B. Kemp, B. S., *Assoc. Prof. and Assoc. Agron.*

‡F. W. Oldenburg, B. S., *Agron. Specialist.*

†R. L. Sellman, B. S., *Asst. Agron.*

Animal Industry: *††DeVoe Meade, Ph. D., *Prof. An. Husb.; An. Husb.*

*††J. A. Gamble, M. S., *Prof. Dairy Husb.; Dairy Husb.*

*†R. H. Waite, M. S., *Prof. Poultry Husb.; Poultry Husb.*

†Harlow Bierman, M. S., *Asst. Dairy Husb.*

‡B. E. Carmichael, M. S., *An. Husb. Specialist.*

*K. A. Clark, M. S., *Asst. Prof. An. Husb.*

‡J. A. Conover, B. S., *Dairy Specialist.*

*S. H. Harvey, M. S., *Asst. Prof. Dairy Husb.*

‡W. H. Rice, B. S., *Poultry Specialist.*

*G. O. Smith, M. S., *Asst. Prof. An. Husb.*

Bacteriology: *†E. M. Pickens, D. V. M., A. M., *Prof. Bact.; An. Path.*

*G. E. Jacobi, D. V. M., *Asst. Prof. Bact.*

*†L. J. Poelma, D. V. M., *Instr. Dairy Bact.; Asst. An. Path.*

*R. C. Reed, Ph. B., D. V. M., *Prof. An. Path.*

*M. F. Welsh, D. V. M., *Asst. Prof. An. Path. and Bact.*

Botany: †J. B. S. Norton, D. Sc., *Bot. and Plant Path.*

†F. S. Holmes, M. S., *Seed Insp.*

†Anna M. Hook, *Asst. in Seed Insp.*

Botany—Continued.

†Olive M. Kelk, *Asst. in Seed Insp.*

†Ruth M. Marston, *Asst. in Seed Insp.*

†Isabella Veitch, *Asst. in Seed Insp.*

Chemistry: Director Patterson, *Sta. Chem.*

*N. E. Gordon, Ph. D., *Prof. Phys. Chem.; (State Chem.).*

*L. E. Bopst, B. S., *Chem. in charge Feed and Fert. Insp.*

*L. B. Broughton, M. S., *Prof. Indus. Chem.*

†H. B. McDonnell, M. S., M. D., *Chem. in An. Path. Invest.*

*R. C. Wiley, M. S., *Assoc. Prof. Chem.*

Education (Agr.): *†H. F. Cotterman, M. A., *Prof. Agr. Ed.*

*F. D. Day, B. S., *Instr. Agr. Ed.*

†C. S. Richardson, A. M., *Specialist in Ed. Ent.*

Engineering (Agr.): *†R. W. Carpenter, A. B., *Prof. Farm Engin.***Entomology:** *††E. N. Cory, M. S., *Prof. Ent.; Ent. (State Ent.).*

†C. C. Hamilton, M. S., *Assoc. Ent.*

*C. J. Pierson, M. A., *Prof. Zool.*

*R. V. Truitt, M. S., *Prof. Aquiculture.*

Extension (Admin.): † Director Symons in charge.

‡F. B. Bomberger, D. Sc., *Asst. Dir. and Specialist in Rural Organ. and Marketing.*

‡Venia M. Kellar, B. S., *State Home Dem. Agt.*

‡E. G. Jenkins, *State Boys' Club Agt.*

‡Dorothy Emerson, *State Girls' Club Agt.*

‡P. W. Chichester, B. S., *Asst. State Boys' Club Agt.*

¹ For subject-matter workers see the respective division, i. e., **agronomy, animal industry, etc.**

² Courses given in College of Education.

Farm Management and Economics: *†W. T. L. Taliaferro, D. Sc., *Prof. Farm Mgt.*

*†S. H. DeVault, Ph. D., *Asst. Prof. Agr. Econ., Marketing Specialist.*

Forestry: *F. W. Besley, M. F., D. Sc., *Lect. on For. (State For.).*

Home Economics: *M. Marie Mount, A. B., *Prof. Home and Institutional Mgt. and Actg. Dean Coll. of Home Econ.*

†Mrs. Marion C. Bell, *Household Mgt. Specialist.*

†Bertha Knight, B. S., *Clothing Specialist.*

*Mrs. Frieda M. McFarland, A. B., *Prof. Textiles and Clothing.*

*Edna B. McNaughton, B. S., *Prof. Home Econ. Ed.*

*Mrs. Claribel P. Welsh, B. A., *Instr. Textiles, Clothing, Foods and Cookery.*

Horticulture: *†E. C. Auchter, Ph. D., *Prof. Hort.; Hort.*

†W. R. Ballard, B. S., *Landsc. and Veg. Gard. Specialist.*

*J. B. Blandford, *Instr. and Hort. Supt.*

†V. R. Boswell, M. S., *Asst. in Veg. Gard.*

*†F. W. Geise, M. S., *Prof. Veg. Gard.; Veg. Brdg.*

†A. L. Schrader, M. S., *Asst. Pomol.*

†S. B. Shaw, B. S., *Hort. Specialist.*

Horticulture—Continued.

*A. S. Thurston, M. S., *Asst. Prof. Flor. and Landsc. Gard.*

†T. H. White, M. S., *Veg. and Flor. Work.*

*W. E. Whitehouse, B. S., *Instr. Pomol.*

Journalism: *†M. D. Bowers, A. B., *Instr. and Specialist in Agr. Journalism.*

†J. M. Hoblitzell, *Asst. in Agr. Journalism.*

Plant Pathology: *†C. E. Temple, M. S., *Prof. Plant Path. (State Plant Path.).*

††R. A. Jehle, Ph. D., *Plant Path.*

Plant Physiology and Biochemistry: *†C. O. Appleman, Ph. D., *Prof. Plant Physiol. and Biochem.; Plant Physiol.*

*†C. M. Conrad, M. S., *Asst. Plant Physiol.*

*†E. S. Johnston, Ph. D., *Assoc. Prof. and Assoc. Plant Physiol.*

Soils: *†A. G. McCall, Ph. D., *Prof. Geol. and Soils; in charge Soil Invest.*

*O. C. Bruce, M. S., *Prof. Soils; Assoc. in Soil Survey.*

†J. M. Snyder, M. S., *Asst. in Soil Invest.*

†H. B. Winant, B. S., *Asst. in Soil Invest.*

Miscellaneous:

*Grace Barnes, B. S., B. L. S., *Libr.*

Substations:

Ridgely Farm, P. O., *Ridgely—Albert White, B. S., Supt.*

Princess Anne Academy for Colored Persons, Princess Anne.

*Agricultural faculty. †Extension staff.

*J. O. Spencer, Ph. D., *President (P. O., Baltimore).*

*T. H. Kiah, Ped. D., *Principal. Theory of Agr.*

*Essie H. Bivens, *Dom. Art.*

*C. E. Clark, *Poultry and An. Husb.*

†Louis Martin, *County Agr. Dem.*

*Laura E. Mullins, *Dom. Sci.*

*J. E. Smith, *Agr. and Chem.*

*Barton White, *Hort. and Biol.*

MASSACHUSETTS.

Massachusetts Agricultural College and the Agricultural Experiment Station, Amherst.

*College faculty. †Station staff. ‡Extension staff.

*K. L. Butterfield, A. M., LL. D., *President. Head Div. Rural Social Sci.*

*E. M. Lewis, A. M., *Dean of Coll.*

†S. B. Haskell, B. S., *Dir. of Sta.*

†J. D. Willard, B. A., *Dir. of Ext. Service.*

Agronomy: *†A. B. Beaumont, Ph. D., *Head of Dept.*

†J. B. Abbott, M. S., *Ext. Prof. Agron.*

†R. L. Coffin, *Invest. in Agron.*

†E. F. Gaskill, M. S., *Asst. Research Prof. Agron.*

†J. P. Jones, M. S., *Asst. Research Prof. Agron.*

*M. O. Lanphear, B. S., *Instr. Agron.*

*C. A. Michels, M. S., *Prof. Agron.*

*C. H. Thayer, *Instr. Agron.*

*G. A. Thelin, B. S., *Instr. Agron.*

Animal Industry: *† — — —, *Head Dept. of An. Husb.*

*†H. F. Judkins, B. S., *Head Dept. of Dairy Husb.*

*†J. C. Graham, B. S., *Head Dept. of Poultry Husb.*

†J. R. Alcock, *Asst. in An. Nutr.*

*Luther Banta, B. S. *Asst. Prof. Poultry Husb.*

Animal Industry—Continued.

†C. J. Fawcett, B. S., *Ext. Prof. An. Husb.*

†O. S. Flint, B. S., *Poultry Disease Work.*

*G. V. Glatfelter, M. S., *Asst. Prof. An. Husb.*

†F. A. Hays, Ph. D., *Research Prof. Poultry Husb.*

†W. P. B. Lockwood, M. S., *Ext. Prof. Dairying.*

†W. C. Monahan, B. S., *Ext. Prof. Poultry Husb.*

†E. H. Nodine, B. S., *Ext. Instr. in charge Poultry Club Work.*

*H. L. Pendleton, B. S., *Instr. Dairy Husb.*

*Marion C. Pulley, B. S., *Instr. Poultry Husb.*

*V. A. Rice, M. Agr., *Asst. Prof. An. Husb.*

†Ruby Sanborn, A. B., *Invest. in Poultry Husb.*

*W. C. Sanctuary, B. S., *Prof. Poultry Husb.*

*R. W. Smith, jr., B. S., *Instr. Dairying.*

*W. C. Thayer, B. S., *Instr. An. Husb.*

*T. G. Yaxis, M. S., *Asst. Prof. Dairying.*

Botany: *†A. V. Osmun, M. S., *Head of Dept*
 †P. J. Anderson, Ph. D., *Research Prof. Bot.*
 †A. S. Ball, *Lab. Asst. in Bot.*
 *†O. L. Clark, B. S., *Asst. Prof. Bot.*
 *W. H. Davis, Ph. D., *Asst. Prof. Bot.*
 †W. L. Doran, M. S., *Asst. Research Prof. Bot.*
 (P. O., Lexington).
 *F. A. McLaughlin, B. S., *Asst. Prof. Bot.*
 *R. E. Torrey, Ph. D., *Asst. Prof. Bot.*
 †Anna M. Wallace, A. M., *Curator, Dept. of Bot.*
Chemistry: *†J. B. Lindsey, Ph. D., *Head Dept.*
of Agr. Chem. Vice Dir. of Sta.
 †H. L. Allen, *Lab. Asst. in Chem.*
 †J. G. Archibald, B. S., *Asst. Research Prof.*
Chem.
 †S. J. Broderick, B. S., *Analyst.*
 *J. S. Chamberlain, Ph. D., *Prof. Org. and*
Agr. Chem.
 †G. B. Dalrymple, *Analyst in Fert. Control.*
 †H. D. Haskins, B. S., *Chem. in Fert. Control.*
 †E. B. Holland, Ph. D., *Research Prof. Chem.*
 †J. T. Howard, *Insp.*
 †C. P. Jones, M. S., *Asst. Research Prof. Chem.*
 †F. J. Kokoski, B. S., *Analyst.*
 †F. W. Morse, M. S., *Research Prof. Chem.*
 *C. A. Peters, Ph. D., *Prof. Inorg. and Soil*
Chem.
 *Paul Serex, jr., Ph. D., *Asst. Prof. Chem.*
 †R. H. Smith, M. S., *Chem. in Fert. Control.*
 †L. S. Walker, B. S., *Asst. Chem. in Fert.*
Control.
Economics (Agr. and Sociol.): *†A. E. Cance,
 Ph. D., *Head Dept. of Agr. Econ.*
 *John Phelan, M. A., *Head Dept. of Rural*
Sociol., Dir. of Short Courses.
 †Lorian P. Jefferson, A. M., *Asst. Research*
Prof. Agr. Econ.
 †R. J. McFall, Ph. D., *Ext. Prof. Agr. Econ.*
 *J. F. Novitski, B. S., *Instr. Rural Sociol.*
 *D. W. Sawtelle, M. S., *Asst. Prof. Agr. Econ.*
 *N. L. Sims, Ph. D., *Prof. Rural Sociol.*
 *H. W. Yount, M. S., *Instr. Agr. Econ.*
Education (Agr.): *W. S. Welles, B. S., *Head of*
Dept.
 *H. N. Glick, A. M., *Prof. Agr. Ed.*
Engineering (Rural): *†C. I. Gunness, B. S.,
Head of Dept.
 *J. B. Newlon, *Instr. Rural Engin.*
 *G. F. Pushee, *Instr. Rural Engin.*
 *J. L. Strahan, M. S., *Asst. Prof. Rural Engin.*
Entomology: *†H. T. Fernald, Ph. D., *Head of*
Dept.
 *C. P. Alexander, Ph. D., *Asst. Prof. Ent.*
 †A. I. Bourne, B. A., *Asst. Research Prof. Ent.*
 *M. H. Cassidy, B. S., *Asst. Prof. Beekeeping.*
 *G. C. Crampton, Ph. D., *Prof. Insect Morphol.*
 †D. S. Lacroix, B. S., *Invest. in Ent.* (P. O.,
 East Wareham.)
 †H. N. Worthley, M. S., *Invest. in Ent.*
Extension (Admin.):¹ Director Willard in charge.
 †R. W. Redman, B. S., *Asst. Dir.*
 †S. R. Parker, B. S., *County Agt. Leader.*
 †Lucile W. Reynolds, B. S., *State Home Dem.*
Leader.
 †G. L. Farley, M. S., *Supvr. Junior Ext. Work.*
 †R. D. Hawley, B. S., *Supvr. Ext. Schools and*
Exhibits.
 †W. F. Howe, *Asst. Supvr. Junior Ext. Work.*

Extension (Admin.)—Continued.
 †Dorothy W. Murdock, *Asst. State Club*
Leader.
Farm Management: *†J. A. Foord, M. S., *Head*
of Dept.
 *M. F. Abell, B. S., *Asst. Prof. Farm Mgt.*
Forestry: *L. R. Grose, M. F., *Head of Dept.*
Home Economics: *Edna L. Skinner, B. S.,
Head of Dept.
 *Mary A. Bartley, B. S., *Instr. Home Econ.*
 *Margaret Hamlin, A. B., *Agr. Counsellor for*
Women.
 †Marion L. Tucker, B. S., *Asst. Ext. Prof.*
Home Econ.
Horticulture: *†F. A. Waugh, M. S., *Head Div. of*
Hort. and of Dept. of Landsc. Gard.
 *†W. W. Chenoweth, M. S., *Head Dept. of Hort.*
Mfrs.
 *†F. C. Sears, M. S., *Head Dept. of Pomol.*
 †J. K. Shaw, Ph. D., *Research Prof. Pomol.*
 *C. L. Thayer, B. S., *Head Dept. of Flor.*
 †J. S. Bailey, M. S., *Invest. in Pomol.*
 †F. E. Cole, jr., *Ext. Asst. Prof. Pomol.*
 †W. R. Cole, *Ext. Asst. Prof. Hort. Mfrs.*
 *B. D. Drain, B. S., *Asst. Prof. Pomol.*
 *A. P. French, M. S., *Instr. Pomol.*
 *R. D. Harris, B. S., *Asst. Prof. Veg. Gard.*
 *A. K. Harrison, *Asst. Prof. Landsc. Gard.*
 †R. M. Koon, M. S., *Ext. Prof. Veg. Gard.*
 *R. T. Muller, M. S., *Asst. Prof. Flor.*
 *G. J. Raleigh, M. S., *Instr. Pomol.*
 *W. F. Robertson, B. S., *Instr. Hort. Mfrs.*
 *R. W. Rogers, B. S., *Asst. Prof. Hort.*
 *G. B. Snyder, B. S., *Instr. Veg. Gard.*
 *C. H. Thompson, M. S., *Asst. Prof. Hort.*
 †V. A. Tiedjens, M. S., *Asst. Research Prof. Veg.*
Gard. (P. O., Lexington).
 *R. A. Van Meter, B. S., *Prof. Pomol.*
 †J. F. Whitney, M. L. A., *Ext. Asst. Prof.*
Landsc. Gard.
 †H. E. Wilson, *Lab. Asst. in Pomol.*
Microbiology: *†C. E. Marshall, Ph. D., *Head of*
Dept. Dir. of Grad. School.
 *R. C. Avery, M. S., *Instr. Microbiol.*
 *Mary E. M. Garvey, B. S., *Instr. Microbiol.*
 *†Arao Itano, Ph. D., *Asst. Prof. Microbiol.*
Physics: *P. B. Hasbrouck, B. S., *Head of Dept.*
 *G. W. Alderman, A. B., *Instr. Phys.*
 *E. A. Harrington, Ph. D., *Prof. Phys.*
Veterinary Science: *†G. E. Gage, Ph. D., *Head*
of Dept.
 †J. B. Lentz, A. B., V. M. D., *Asst. Research*
Prof. Vet. Sci.
 †N. J. Pyle, D. V. M., *Asst. Research Prof.*
Avian Path.
Zoology and Geology: *C. E. Gordon, Ph. D.,
Head of Dept.
 *P. E. Foss, B. S., *Instr. Zool.*
Miscellaneous:
 *†H. S. Green, A. B., LL. D., *Libr.*
 *†F. C. Kenney, *Treas.*
 †J. E. Ostrander, A. M., C. E., *Met.*
 *R. J. Watts, B. S., *Secy.*
Substations:
 Cranberry Substa., P. O., East Wareham—
 H. J. Franklin, Ph. D., *Supt.*
 Market Garden Field Sta., P. O., Lexington
 ————— in charge.

¹ For subject-matter workers see the respective division, i. e., agronomy, animal industry, etc.

MICHIGAN.

The Michigan Agricultural College and the Agricultural Experiment Station, East Lansing.

*College faculty. †Station staff. ‡Extension staff.

*R. S. Shaw, D. Agr., *Actg. President, Dean of Agr., Dir. of Sta.*
 †R. J. Baldwin, B. S., *Dir. of Ext. Work.*
 G. W. Bissell, M. E., *Dean Div. of Engin.*

Animal Industry: *†G. A. Brown, B. S., *Head of An. Husb. Dept.*

*†O. E. Reed, M. S., *Head of Dairy Husb. Dept.*

*†E. C. Foreman, B. S., *Assoc. Prof. and Head of Poultry Husb. Dept.*

‡R. H. Addy, B. S., *Dairy Husb. Specialist.*

‡A. C. Baltzer, B. S., *Dairy Husb. Specialist.*

*†G. A. Branaman, B. S., *Asst. An. Husb.*

*†J. E. Burnett, M. Agr., *Assoc. Prof. Dairy Husb.; Research Assoc. in Dairying.*

*C. G. Card, B. S., *Asst. Prof. Poultry Husb.*

*†W. E. J. Edwards, B. S., *Assoc. Prof. and Research Asst. in An. Husb.*

*C. M. Ferguson, B. S., *Asst. Prof. Poultry Husb.*

‡V. A. Freeman, B. S., *An. Husb. Specialist.*

‡J. A. Hannah, B. S., *Poultry Specialist.*

‡J. G. Hays, B. S., *Dairying Specialist.*

*R. S. Hudson, B. S., *Farm Supt.*

†C. F. Huffman, M. S., *Research Asst. in Dairying.*

*†P. S. Lucas, B. S., *Assoc. Prof. Dairy Mfrs.; Research Assoc. in Dairying.*

*†A. C. Weimar, B. S., *Assoc. Prof. Dairy Mfrs.; Research Assoc. in Dairying.*

‡J. G. Wells, B. S., *Dairy Specialist.*

*William Wise, *Foreman of Poultry Plant.*

Botany: *†E. A. Bessey, Ph. D., *Head of Dept.*

†C. W. Bennett, M. S., *Research Asst. in Plant Path.*

*†G. H. Coons, Ph. D., *Assoc. Prof. and Assoc. Bot.*

*H. T. Darlington, Ph. D., *Assoc. Prof. Bot.*

*Richard de Zeeuw, Ph. D., *Assoc. Prof. Bot.*

*†R. P. Hibbard, Ph. D., *Assoc. Prof. Bot.; Research Assoc. in Plant Physiol.*

†J. E. Kotila, M. S., *Research Asst. in Plant Path.*

†Ray Nelson, B. S., *Asst. in Plant Path.*

*Bertha E. Thompson, M. A., *Asst. Prof. Bot.*

*E. F. Woodcock, Ph. D., *Asst. Prof. Bot.*

Chemistry: *A. J. Clark, A. B., *Prof. and Head of Dept.*

†A. J. Patten, B. S., *Chem.*

*C. D. Ball, B. S., *Asst. Prof. Chem.*

*R. L. Baxter, B. S., *Instr. Chem.*

*D. T. Ewing, Ph. D., *Assoc. Prof. Chem.*

†M. Louise Grottenberger, B. S., *Asst. in Chem.*

*B. E. Hartsuch, A. B., *Assoc. Prof. Chem.*

*R. C. Huston, Ph. D., *Assoc. Prof. Chem.*

*H. D. Lightbody, M. S., *Asst. Prof. Chem.*

*W. C. Lewis, M. A., *Instr. Chem.*

†A. W. Lowell, B. S., *Asst. Chem.*

†E. J. Miller, Ph. D., *Research Assoc. in Chem.*

*H. S. Reed, B. S., *Assoc. Prof. Chem.*

†C. S. Robinson, Ph. D., *Research Assoc. Chem.*

†O. B. Winter, A. B., *Research Assoc. Chem.*

Economics (Agr.): *W. O. Hedrick, Ph. D., *Prof. Econ.*

‡W. C. Cribbs, *Agt. in Marketing.*

*C. S. Dunford, M. A., *Assoc. Prof. Econ.*

*E. A. Gee, A. B., *Asst. Prof. Econ.*

*J. T. Horner, B. S., *Assoc. Prof. Econ. and Accounting.*

‡Gifford Patch, Jr., B. S., *Market Specialist.*

*†F. T. Riddell, B. S., *Instr. and Asst. Farm Mgt.*

*J. W. Scott, M. A., *Assoc. Prof. Econ.*

*Royal Steiner, M. A., *Asst. Prof. Econ.*

Education (Agr.): ———— *Head of Dept., Dir. Voc. Teacher Training.*

*Katherine Andrews, *Asst. Critic Teacher in Home Econ.*

*E. L. Grover, B. S., *Assoc. Prof. Agr. Ed.*

*B. A. Walpole, B. S., *Asst. Prof. Agr. Ed.*

Entomology: *†R. H. Pettit, B. S., *Head of Dept.*

‡Edwin Ewell, *Specialist in Apiculture.*

*L. G. Gentner, M. S., *Instr. Ent.*

‡J. H. Harman, B. S., *Specialist in Insect Control.*

*R. H. Kely, B. S., *Instr. Apiculture.*

*J. C. Kremer, *Instr. Apiculture.*

*Eugenia I. McDaniel, A. B., *Asst. Prof. and Research Asst. Ent.*

Extension (Admin.): † Director Baldwin *in charge.*

‡Hale Tennant, B. A., *Asst. Dir. in charge County Agt. Work and Markets.*

‡Mrs. Louise H. Campbell, B. S., *State Home Dem. Leader.*

‡R. A. Turner, B. S., *State Club Leader.*

‡E. G. Amos, B. S., *Asst. County Agt. Leader (P. O., Marquette).*

‡C. V. Ballard, B. S., *Asst. County Agt. Leader.*

‡R. G. Carr, B. S., *Asst. County Agt. Leader.*

‡Ruth M. Cresswell, B. S., *Asst. State Club Leader (P. O., Marquette).*

‡J. B. Hasselman, A. B., *Super. Publicity Work.*

‡A. G. Kettunen, B. S., *Asst. State Club Leader (P. O., Marquette).*

‡Adele Koch, M. S., *Asst. State Home Dem. Leader.*

‡K. H. McDonel, B. S., *Asst. to Dir.*

‡Nevels Pearson, B. S., *Asst. State Club Leader.*

‡Ida M. Siehler, B. S., *Asst. State Home Dem. Leader (P. O., Marquette).*

‡Harriet Wilder, A. B., *Asst. State Club Leader.*

Farm Crops: *†J. F. Cox, B. S., *Head of Dept.*

*†H. M. Brown, M. S., *Instr. and Research Asst. in Farm Crops.*

*C. E. Cormany, M. S., *Asst. Prof. and Asst. in Farm Crops.*

†E. E. Down, B. S., M. Agr., *Asst. in Farm Crops (Coop. U. S. D. A.).*

*†J. R. Duncan, *Instr. and Asst. in Farm Crops.*

‡L. D. Kurtz, *Farm Crops Specialist.*

‡ For subject-matter workers see the respective division, i. e., animal industry, botany, etc.

Farm Crops—Continued.

- *†C. R. Megee, A. M., *Assoc. Prof. and Research Assoc. in Farm Crops.*
 †H. C. Moore, B. S., *Research Asst. in Farm Crops, Potato Specialist.*
 †D. F. Rainey, B. S., *Asst. in Farm Crops.*
 †H. C. Rather, B. S., *Farm Crops Specialist.*
 *†F. A. Spragg, M. S., *Assoc. Prof. Farm Crops; Research Assoc. in Crop Brdg. (Coop. U. S. D. A.).*
 †J. W. Weston, B. S., *Research Asst. in Farm Crops, Potato Specialist.*

Farm Mechanics: *†H. H. Musselman, B. S., *Head of Dept.*

- †George Amundson, B. S., *Specialist in Land Clearing (P. O., Marquette).*
 *†F. E. Fogle, B. S., *Asst. Prof. and Asst. in Farm Mech.*
 *†H. J. Gallagher, M. Agr., *Instr. and Asst. in Farm Mech.*
 *G. S. Getman, *Instr. Farm Mech., Field Foreman in Farm Crops.*
 *R. E. Hammond, *Instr. Farm Mech.*
 †N. A. Kessler, *Specialist in Land Clearing.*
 †L. F. Livingston, B. S., *Specialist in Land Clearing.*
 *H. L. Publow, B. S., Ch. E., *Asst. Prof. Chem. Engin.*
 †O. E. Robey, B. S., *Household Engin. and Drainage Specialist.*
 *†E. C. Sauve, B. S., *Asst. Prof. and Asst. in Farm Mech.*

Forestry: *†A. K. Chittenden, M. F., *Head of Dept.*

- *†J. C. DeCamp, M. F., *Asst. Prof. For.*
 *††P. A. Herbert, M. F., *Asst. Prof. and Asst. For.*

Home Economics: *Jean Krueger, Ph. D., *Dean of Div.*

- *Elizabeth Bemis, B. S., *Supvr. Institutional Mgt.*
 *Sylvia I. Borgman, B. S., *Instr. Home Econ.*
 *Louise I. Clemens, B. S., *Assoc. Prof. Home Econ.*
 *Grace Cone, *Instr. Home Econ.*
 *Ruth M. Cowan, M. S., *Asst. Prof. Home Econ.*
 *Marie Dye, Ph. D., *Assoc. Prof. Home Econ.*
 *Mrs. Josephine R. Fogle, B. S., *Asst. Prof. Home Econ. Ed.*
 *Emma P. Garrison, B. S., *Asst. Prof. Home Econ. Ed.*
 *Winifred S. Gettemy, *Assoc. Prof. Household Art.*
 *Irma H. Gross, B. S., *Instr. Home Econ.*
 *Josephine Hoffarth, Ph. D., *Instr. Home Econ.*
 *Osee Hughes, B. A., *Assoc. Prof. Household Sci.*
 *Mrs. Lola Person, *Instr. Home Econ.*
 †Marion H. Rogers, B. S., *Specialist in Household Mgt.*
 †Eunice Ryan, M. A., *Clothing and Textiles Specialist.*
 *Mary Shellenberger, B. S., *Instr. Home Econ.*
 *Julia Tear, A. B., *Asst. Prof. Home Econ.*
 *Ethel G. Webb, B. S., *Assoc. Prof. Home Econ.*

Horticulture: *†V. R. Gardner, M. S., *Head of Dept.*

- *C. P. Halligan, B. S., *Head of Landsc. Gard.*
 *†F. C. Bradford, M. S., *Assoc. Prof. and Assoc. Hort.*
 †H. A. Cardinell, B. S., *Hort. Specialist.*
 *J. W. Crist, Ph. D., *Asst. Prof. Hort.*
 †W. C. Dutton, B. S., *Research Assoc. in Hort.*
 *Thomas Gunson, *Asst. Prof. Hort., Supt. of Grounds.*
 †H. D. Hootman, *Asst. Hort.*
 *†E. P. Lewis, M. S., *Instr. and Asst. in Hort.*
 *†R. E. Loree, B. S., *Asst. Prof. and Asst. in Hort.*
 *†R. E. Marshall, M. S., *Assoc. Prof. and Research Assoc. Hort.*
 *†N. L. Partridge, Ph. D., *Asst. Prof. and Research Asst. in Pomol.*
 †G. E. Starr, *Assoc. Hort. in charge Plant Brdg. Work.*

Meteorology: *D. A. Seeley, M. S., *Instr. Met.***Soils:** *†M. M. McCool, Ph. D., *Head of Dept.*

- *S. G. Bergquist, A. B., *Instr. Geol.*
 †G. J. Bouyoucos, Ph. D., *Research Assoc. in Soils.*
 *C. W. Chapman, B. S., *Prof. Phys.*
 ††G. M. Grantham, B. S., *Research Assoc. in Soils.*
 *††P. M. Harmer, Ph. D., *Asst. Prof. and Research Assoc. in Soils.*
 *W. E. Laycock, A. B., *Assoc. Prof. Phys.*
 *†C. E. Millar, Ph. D., *Assoc. Prof. and Research Assoc. in Soils.*
 *†O. B. Price, A. M., *Instr. and Research Asst. in Soils.*
 †C. H. Spurway, M. Agr., *Research Assoc. in Soils.*
 †F. W. Trull, B. S., *Asst. in Soils.*
 †James Tyson, B. S., *Asst. in Soils.*
 †J. O. Veatch, A. B., *Research Asst. in Soils.*
 *A. G. Weidemann, B. S., *Asst. in Soils.*
 *†L. C. Wheeting, M. S., *Asst. Prof. and Research Assoc. in Soils.*

Veterinary Medicine: *†Ward Giltner, D. V. M., M. S., *Dean of Dept., Prof. Bact. and Hyg.; Bact.*

- *F. W. Chamberlain, B. S., D. V. M., *Prof. Vet. Anat.*
 *†W. L. Chandler, Ph. D., *Asst. Prof. and Research Assoc. in Bact.*
 †L. H. Cooledge, A. M., *Research Assoc. Bact.*
 *†F. W. Fabian, B. S., *Assoc. Prof. Bact. and Hyg.; Research Assoc. in Bact.*
 *†E. T. Hallman, D. V. M., *Assoc. Prof. An. Path.; An. Path.*
 *†I. F. Huddleson, M. S., *Asst. Prof. and Research Assoc. Bact.*
 *J. P. Hutton, D. V. M., *Assoc. Prof. Vet. Surg. and Clinics.*
 *H. E. Johnson, D. V. M., *Asst. Prof. Comp. Anat.*
 *†W. Le R. Mallman, B. S., *Asst. Prof. and Research Assoc. Bact.*
 *B. B. Roseboom, B. S., *Assoc. Prof. Physiol.*
 *†G. L. A. Ruehle, M. S., *Asst. Prof. and Research Assoc. Bact.*

Veterinary Medicine—Continued.

*R. A. Runnells, D. V. M., *Asst. Prof. An. Path.*

*E. K. Sales, D. V. M., *Asst. Prof. Vet. Surg.*

†R. M. Snyder, Ph. D., *Research Assoc. in Bact.*

*†H. J. Stafseth, D. V. M., M. S., *Assoc. Prof. and Research. Assoc. Bact.*

*O. A. Taylor, D. V. M., *Asst. Prof. Vet. Path.*

Zoology: *†H. R. Hunt, Ph. D., *Prof. Zool.; An. Geneticist.*

*J. W. Stack, M. S., *Instr. Zool.*

Miscellaneous:

*A. M. Berridge, B. S., M. Agr., *Dir. of Short Courses.*

Miscellaneous—Continued.

*R. M. Harford, *Photog.*

*E. B. Hill, B. S., M. Agr., *Asst. Ho. Dean and Dir.*

*Mrs. Linda E. Landon, *Libr.*

Substations:

Graham Hort. Expt. Sta., *R. F. D. 7, Grand Rapids—H. M. Wells, B. S., Supt.*

South Haven Sta., *P. O., South Haven—Stanley Johnston, B. S., Supt.*

Upper Peninsula Substa., *P. O. Chatham—G. W. Putnam, M. S., Dir. and Research Assoc. in Farm Crops.*

H. R. Pettigrove, B. S., *Farm Crop Experiment.*

MINNESOTA.

Department of Agriculture (College of Agriculture, Forestry, and Home Economics, the School of Agriculture, and the Agricultural Experiment Station) of the University of Minnesota, University Farm, St. Paul.

*College faculty. †Station staff. ‡Extension staff.

*L. D. Coffman, Ph. D., *President of University (P. O., Minneapolis).*

*†W. C. Coffey, M. S., *Dean Dept. of Agr., Dir. of Sta.*

*†E. M. Freeman, Ph. D., *Dean Coll. of Agr., For., and Home Econ.*

†F. W. Peck, M. S., *Dir. of Agr. Ext. and Supt. of Farmers' Insts.*

O. M. Leland, C. E., *Dean Coll. of Engin. (P. O., Minneapolis).*

Agronomy and Farm Management: *†Andrew Boss, *Chief of Div. Vice Dir. of Sta.*

*†H. K. Hayes, D. Sc., *Prof. Plant Brdg.; Assoc. Agron. in charge Plant Brdg. (Coop. U. S. D. A.).*

*†A. C. Arny, M. S., *Assoc. Prof. and Assoc. Agron. in charge Farm Crops.*

*†L. B. Bassett, *Assoc. Prof. and Assoc. in Farm Mgt.*

*†H. E. Brewbaker, M. S., *Instr. and Asst. in Plant Brdg.*

††R. F. Crim, B. S., *Crop Specialist.*

*†L. F. Garey, M. A., *Asst. Prof. Farm Mgt.; Asst. in Farm Mgt. Invest.*

*†Fred Griffee, M. S., *Instr. and Asst. Agron.*

†August Haedecke, *Asst. in Agron.*

†F. L. Higgins, *Asst. in Farm Mgt.*

†A. T. Hoverstad, B. S., *Asst. in Farm Mgt.*

*†F. W. McGinnis, M. S., *Asst. Prof. and Asst. Agron.*

*†G. A. Pond, M. S., *Asst. Prof. Farm Mgt.; Asst. Agr. (Coop. U. S. D. A.).*

*†F. H. Steinmetz, M. S., *Instr. Farm Crops; Asst. Agron.*

Animal Industry: *†W. H. Peters, M. Agr., *Chief Div. of An. Husb.*

*†C. H. Eckles, D. Sc., *Chief Div. of Dairy Husb.*

*†A. C. Smith, B. S., *Chief Div. of Poultry Husb.*

†C. G. Aamodt, *Asst. in Poultry Husb.*

*P. A. Anderson, B. S., *Asst. Prof. An. Husb.*

†N. E. Chapman, M. A., *Poultry Specialist.*

†Cora Cooke, B. S., *Poultry Specialist.*

*†C. D. Dahle, M. S., *Asst. Prof. and Asst. in Dairy Husb.*

†A. A. Dowell, B. S., *Livestock Specialist.*

*†E. F. Ferrin, M. Agr., *Prof. and Asst. Chief An. Husb.*

*†T. W. Gullickson, M. S., *Asst. Prof. and Asst. in Dairy Husb.*

Animal Industry—Continued.

†E. A. Hanson, B. S., *Dairy Specialist.*

*†A. L. Harvey, M. S., *Instr. An. Husb.; Asst. in Beef Cattle Husb.*

*†M. A. McCarty, B. S., *Instr. and Asst. An. Husb.*

*†Harold Macy, B. S., *Asst. Prof. and Asst. Dairy Bact.*

*†W. E. Petersen, M. S., *Asst. Prof. Dairy Husb.; Supt. Official Tests.*

*†O. G. Schaefer, M. S., *Assoc. Prof. and Assoc. Dairy Husb.*

†H. R. Searles, B. S., *Dairy Specialist.*

*†H. W. Vaughan, M. S., *Prof. and Asst. An. Husb.; in charge Beef Cattle Husb.*

†L. V. Wilson, B. S., *Livestock Specialist.*

†H. G. Zavoral, B. S., *Livestock Specialist.*

Biochemistry (Agr.): *†R. A. Gortner, Ph. D., *Chief of Div.*

*†C. H. Bailey, Ph. D., *Prof. Agr. Biochem.; Assoc. Agr. Biochem. in charge Cereal Tech.*

†F. R. Davison, M. S., *Asst. in Plant Physiol.*

*J. R. Haag, M. S., *Instr. Agr. Biochem.*

†W. F. Hoffman, M. S., *Asst. Chem.*

*†Cornelia Kennedy, Ph. D., *Asst. Prof. and Asst. Agr. Biochem.*

*C. A. Morrow, Ph. D., *Asst. Prof. Agr. Biochem.*

*†L. S. Palmer, Ph. D., *Assoc. Prof. Agr. Biochem.; Dairy Chem.*

†R. C. Sherwood, Ph. G., *Asst. Chem.*

†G. S. Taylor, A. B., *Asst. Agr. Biochem.*

*†J. J. Willaman, Ph. D., *Assoc. Prof. Plant Chem.; Plant Chem.*

Economics (Agr.): *†J. D. Black, Ph. D., *Chief of Div.*

*†C. M. Arthur, B. S., *Instr. and Research Asst. in Agr. Econ.*

†W. L. Cavert, M. S., *Farm Mgt. Dem.*

Economies (Agr.)—Continued.

- *†C. F. Clayton, A. M., *Instr. Agr. Econ.; Asst. Economist.*
 *†E. W. Gaumnitz, M. A., *Instr. Agr. Econ.; Asst. Economist.*
 *†B. A. Holt, M. A., *Instr. Agr. Econ.; Asst. Economist.*
 *†E. C. Johnson, B. S., *Instr. Agr. Econ.*
 †Hutzel Metzger, M. S., *Research Asst. in Agr. Econ.*
 †Laurence Myers, M. S., *Research Asst. in Agr. Econ.*
 *†H. B. Price, Ph. D., *Assoc. Prof. Agr. Econ.; Asst. Economist.*
 *W. C. Waite, B. S., *Instr. Agr. Econ.*
 *†Holbrook Working, Ph. D., *Assoc. Prof. Agr. Econ.; Asst. Economist.*

Education (Agr.): *A. V. Storm, Ph. D., *Chief of Div., Dir. of Short Courses.*

- *D. D. Mayne, *Prof. Agr. Pedag., Prin. School of Agr.*
 *Sherman Dickinson, M. A., *Instr. Agr. Ed.*
 *W. P. Dyer, M. A., *Asst. Prof. Agr. Ed.*
 *A. M. Field, M. S., *Asst. Prof. Agr. Ed.*
 *F. W. Lathrop, Ph. D., *Asst. Prof. Agr. Ed.*

Engineering (Agr.): *†William Boss, *Chair. of Group.*

- *J. G. Dent, *Instr. Farm Engin.*
 ———, *Asst. Prof. Farm Drainage; Drainage Engin.*
 *M. G. Jacobson, *Instr. Farm Bldgs.*
 †C. E. Johnson, B. S., *Asst. in Land Clearing.*
 *A. D. Johnston, *Instr. Agr. Engin.*
 *†H. B. Roe, B. S., *Assoc. Prof. Farm Engin.; in charge Sec. of Drainage.*
 *†A. J. Schwantes, *Asst. Prof. and Specialist in Land Clearing.*
 *†E. A. Stewart, B. S., *Assoc. Prof. Agr. Phys., Assoc. Agr. Physicist.*
 *M. J. Thompson, M. S., *Assoc. Prof. Farm Engin. (Land Clearing: P. O., Duluth).*
 *†J. B. Torrance, B. S., *Asst. Prof. Farm Engin. in charge Sec. of Farm Mech.*
 *A. G. Tyler, *Asst. Prof. Agr. Phys.*
 *†H. B. White, B. S., *Asst. Prof. and in charge Sec. of Farm Bldgs.*

Entomology and Zoology: *†W. A. Riley, Ph. D., *Chief of Div.*

- *†Francis Jager, *Chief Div. of Bee Culture.*
 *†R. N. Chapman, Ph. D., *Asst. Prof. An. Biol.; Asst. Ent.*
 †Gerard Dikmans, D. V. M., *Asst. in Parasitol.*
 †P. M. Gilmer, M. A., *Asst. in Ent. and Econ. Zool.*
 *†S. A. Graham, Ph. D., *Asst. Prof. and Asst. in Econ. Ent.*
 *†W. E. Hoffmann, A. B., *Instr. and Asst. Ent.*
 *†H. H. Knight, Ph. D., *Asst. Prof. Ent.; Asst. in Parasitol.*
 †O. C. McBride, A. M., *Asst. Ent.*
 *†G. C. Matthews, B. S., *Asst. Prof. Beekeeping; Asst. Apiarist.*
 †C. E. Mickel, M. S., *Asst. in Econ. Ent.*
 *†A. G. Ruggles, M. A., *Prof. Econ. Ent.; Ent. (State Ent.).*
 *†J. W. Thompson, B. S., *Asst. in Bee Culture.*
 *†F. L. Washburn, M. A., *Prof. Econ. Zool.; Econ. Zool.*

Extension (Admin.): †Director Peck *in charge.*

- †F. E. Balmer, B. S., *County Agt. Leader.*
 †Julia O. Newton, B. A., *State Home Dem. Leader.*
 †T. A. Erickson, B. A., *State Club Leader.*
 †F. J. Brown, *Asst. County Agt. Leader.*
 †S. B. Cleland, B. S., *Asst. County Agt. Leader.*
 †G. F. Howard, *Asst. State Club Leader.*
 †Mrs. Genevieve B. Meybohm, B. S., *Asst. State Club Leader.*
 †W. E. Morris, B. S., *Asst. County Agt. Leader.*
 †J. M. Drew, *Asst. in Ext. Work.*

Forestry: *†E. G. Cheyney, B. A., *Chief of Div.*

- *†J. H. Allison, M. F., *Prof. and Assoc. For.*
 *†J. P. Wentling, M. A., *Assoc. Prof. and Assoc. For.*

Home Economies: *Wylle B. McNeal, M. A., *Chief of Div.*

- *Edna Amidon, B. S., *Instr. Home Econ.*
 *Edla Anderson, M. S., *Asst. Prof. Home Econ.*
 *Alice M. Biester, M. A., *Assoc. Prof. Nutr.*
 *Carlotta M. Brown, *Instr. Millinery.*
 *Clara M. Brown, B. A., *Asst. Prof. Home Econ.*
 †Mary L. Bull, *Home Mgt. Specialist.*
 *Mrs. Fern S. Burns, B. S., *Asst. in Institutional Mgt.*
 *Alice M. Child, M. A., *Asst. Prof. Foods and Cookery.*
 *Ruby Coon, M. S., *Instr. Home Econ.*
 *Hally J. Fisher, R. N., *Instr. Home Nursing.*
 *Harriet Goldstein, *Assoc. Prof. Drawing and Design.*
 *Vetta Goldstein, *Instr. Drawing and Design.*
 †Inez Hobart, M. A., *Nutr. Specialist.*
 †Nora M. Hotz, B. S., *Clothing Specialist.*
 *Aura Keever, B. S., *Instr. Textiles and Clothing.*
 *Agnes Kolshorn, M. A., *Instr. Home Econ.*
 †Lily A. Lenhart, *Clothing Specialist.*
 *Jessie McMahon, M. S., *Instr. Home Econ.*
 *Amy P. Morse, B. A., *Asst. Prof. Drawing and Design.*
 *Paulina Nickell, B. S., *Instr. Home Econ.*
 *Ruth D. Noer, B. S., *Instr. Textiles.*
 *Fern Osbeck, B. S., *Instr. Foods Mgt.*
 *E. Maud Patchin, B. S., *Asst. Prof. Textiles and Clothing.*
 *Alpha Peterson, B. S., *Instr. Home Econ.*
 *Ethel L. Phelps, M. S., *Asst. Prof. Textiles and Clothing.*
 *Lenore Richards, B. A., *Asst. Prof. Institutional Mgt.*
 *Jessie Richardson, *Instr. Home Econ.*
 *Irene Sell, Ph. B., *Instr. Home Econ.*
 *Louise Sobyte, *Instr. Home Econ.*
 *Louise Stoddard, *Instr. Textiles and Clothing.*
 *Lucy A. Studley, M. A., *Asst. Prof. Home Econ.*
 *Nola Treat, B. S., *Asst. Prof. Institutional Mgt.*
 *Marion Weller, B. A., *Assoc. Prof. Textiles and Clothing.*
- Horticulture:** *†W. H. Alderman, B. S., *Chief of Div.*
 *†J. H. Beaumont, B. S., *Instr. and Asst. Hort.*
 *†W. G. Brierley, M. S., *Assoc. Prof. and Assoc. Hort.*

† For subject-matter workers see the respective division, i. e., agronomy, animal industry, etc.

Horticulture—Continued.

- †B. I. Burrell, B. S., *Asst. in Hort.*
 *†C. E. Cary, B. S., *Asst. Prof. Hort., Special Lect. in Landsc. Gard.*
 *†F. A. Krantz, M. S., *Asst. Prof. and Asst. Hort.*
 †R. S. Mackintosh, M. S., *Hort. Specialist.*
 *†J. A. Middleton, B. S., *Instr. and Asst. Hort.*
 *†A. N. Wilcox, M. S., *Instr. and Asst. Hort.*

Journalism: *†W. P. Kirkwood, M. A., *Chief Div. of Pubs. and Rural Journalism.*

- †G. D. George, *Illustrator.*
 †Alice McFeely, *Asst. Editor.*
 †E. C. Torrey, *Publicity Specialist.*

Plant Pathology and Botany: Dean Freeman *in charge.*

- *†E. C. Stakman, Ph. D., *Prof. and Assoc. Plant Path. (Coop. U. S. D. A.).*
 †J. J. Christensen, M. S., *Asst. in Plant Path.*
 †F. M. Eaton, B. S., *Asst. in Plant Path.*
 †H. H. Flor, B. S., *Lab. Asst. in Plant Path.*
 *†H. C. Gilbert, M. S., *Instr. Agr. Bot.; Asst. in Plant Path.*
 *†R. B. Harvey, Ph. D., *Assoc. Prof. and Assoc. Plant Physiol.*
 †Henry Hecker, B. S., *Asst. Plant Path.*
 †A. W. Henry, Ph. D., *Asst. Plant Path.*
 †C. R. Hursh, Ph. D., *Asst. Plant Path. (Coop. U. S. D. A.).*
 *†A. H. Larson, B. S., *Asst. Prof. Plant Path.; Asst. Seed Analyst.*
 *†J. G. Leach, Ph. D., *Asst. Prof. and Asst. Plant Path.*
 †R. M. Nelson, B. S., *Asst. in For. Path.*
 †L. O. Regeimbal, B. S., *Expt. Lab. Asst.*
 †R. C. Rose, M. S., *Plant Path. Specialist.*
 *†J. L. Seal, M. S., *Instr. and Asst. in Plant Path.*
 †Ruby Ure, *Seed Analyst.*

Soils: *†F. J. Alway, Ph. D., *Chief of Div.*

- †G. B. Bodman, B. S., *Asst. in Soils.*
 †Skuli Hrutflord, B. S., *Asst. in Soils.*
 *†P. R. McMiller, M. S., *Instr. Soils; Asst. Soils Chem.*

Soils—Continued.

- †William Methley, *Asst. in Soils.*
 †G. H. Nesom, B. S., *Soils Specialist.*
 †R. M. Pinckney, A. M., *Research Asst. in Soils.*
 *†C. O. Rost, Ph. D., *Assoc. Prof. Soils; Asst. Soils Chem.*

Veterinary Medicine: *†C. P. Fitch, D. V. M., *Chief of Div.*

- †W. A. Billings, D. V. M., *Vet. Med. Specialist.*
 *†W. L. Boyd, D. V. M., *Prof. Vet. Med.; in charge Sec. of Vet. Med. and Path.*
 *E. A. Hewitt, D. V. M., *Asst. Prof. Vet. Med.*
 *†H. C. H. Kernkamp, D. V. M., *Asst. Prof. Vet. Med.; Asst. Vet.*
 †R. E. Lubbehusen, D. V. M., *Asst. An. Path.*
 *†M. H. Reynolds, M. D., *Prof. Vet. Med.; in charge Sec. of Vet. Sanitation.*

Miscellaneous:

- *†Harriet W. Sewall, B. A., *Libr.*

Substations:

- Forest Expt. Sta., P. O., *Cloquet—*
 G. H. Wiggin, B. S., *Asst. Supt.*
 T. S. Hansen, M. F., *Asst. Forester.*
 Fruit Brdg. Farm, P. O., *Excelsior—*Fred Haralson, *Asst. Supt.*
 North Central Substa., P. O., *Grand Rapids—*
 O. I. Bergh, B. S., *Supt.*
 NE. Dem. Farm and Substa., P. O., *Duluth—*
 M. J. Thompson, M. S., *Supt.*
 NW Substa., P. O., *Crookston—*
 C. G. Selvig, M. A., *Supt.*
 R. S. Dunham, B. S., *Agron.*
 O. M. Kiser, B. S., *An. Husb.*
 T. M. McCall, B. S., *Hort. and Field Mgr.*
 A. M. Pilkey, *Poultryman.*
 SE. Dem. Farm and Substa., P. O., *Waseca—*
 R. E. Hodgson, M. S., *Supt.*
 West Central Substa., P. O., *Morris—*
 P. E. Miller, M. Agr., *Supt.*
 J. A. Anderson, B. S., *Asst. Hort.*
 R. O. Bridgford, B. S., *Agron.*
 P. S. Jordan, B. S., *An. Husb.*

MISSISSIPPI.**Mississippi Agricultural and Mechanical College and Agricultural Experiment Station, A. and M. College.**

*College faculty. †Station staff. ‡Extension staff.

- *D. C. Hull, M. S., *President.*
 *J. C. Robert, M. D., M. S., *Dean School of Agr.*
 †J. R. Ricks,¹ M. S., *Dir. of Sta.*
 †R. S. Wilson, B. S., *Dir. of Ext. Work.*
 *B. M. Walker, Ph. D., *Dean School of Engin. Vice Pres. of Coll.*

Agronomy: {Dean Robert, *Prof. Agron.*
 {Director Ricks, *Sta. Agron.*

- *A. G. Burg, M. S., *Assoc. Prof. Agron.*
 *F. O. Cork, B. S., *Instr. Agron.*
 †Rowland Cowart, M. S., *Asst. Agron.*
 †D. W. McIlwain, *Agron. Foreman.*
 *R. D. Morrow, B. S., *Asst. Prof. Agron.*
 †J. F. O'Kelly, M. S., *Plant Breeder.*

Animal Industry: *†Enoch Barnett, V. M. D., *Prof. An. Husb.*

¹ Director of all substations.

Animal Industry—Continued.

- †G. S. Templeton, B. S., *An. Husb.*
 *†J. S. Moore, M. S., *Prof. Dairy Husb.; Dairy Husb.*
 *†E. P. Clayton, *Prof. Poultry Husb.; Poultry Husb.*
 *P. G. Bedenbaugh, B. S., *Asst. Prof. An. Husb.*
 †E. P. Brintnall, M. S., *Assoc. Dairy Husb.*
 *J. P. H. Clayton, B. S., *Instr. Poultry Husb.*

Animal Industry—Continued.

- *W. C. Cowser, B. S., *Instr. Dairy Husb.*
 †H. C. Ferguson, B. S., *Agt. in Dairying (Coop. U. S. D. A.: P. O., Jackson).*
 *F. H. Herzer, B. S., *Assoc. Prof. Dairying; Assoc. Dairy Husb.*
 †L. A. Higgins, B. S., *Dairy Husb.*
 *Donald McCluer, B. S., *Asst. Prof. An. Husb.*
 †Duff Maxwell, *Herdsmen.*
 †P. F. Newell, *Swine Husb. Specialist.*
 †G. R. Sipe, *Ext. Poultry Husb.*
 *H. C. Stone, *Instr. Dairy Husb.*
 †Mina A. Willis, M. S., *Agt. in Dairying (Coop. U. S. D. A.).*

Bacteriology: *†C. F. Briscoe, Ph. D., *Prof. Bact.; Bact.*

- *†H. H. Harned, M. S., *Assoc. Prof. and Asst. Bact.*

Botany: *†J. M. Beal, M. S., *Prof. Bot.; Bot.*

- †H. D. Barker, Ph. D., *Assoc. Plant Path.*
 *D. M. Dowdell, jr., B. S., *Asst. Prof. Bot.*
 *J. C. McKee, B. S., *Assoc. Prof. Bot.*
 †D. C. Neal, M. S., *Plant Path.*
 *L. J. Pessin, Ph. D., *Asst. Prof. Bot.*

Chemistry: *†W. F. Hand, Ph. D., *Prof. Chem.; Chem. (State Chem.).*

- *C. S. Black, M. A., *Assoc. Prof. Chem.*
 *G. W. Carroll, B. A., *Assoc. Prof. Chem.*
 *H. J. Smith, Ph. D., *Prof. Chem.*

Economics (Agr.): *†J. N. Lipscomb, M. S., *Prof. Agr. Econ.; Agr. Econ. (Coop. U. S. D. A.).*

- †Mrs. Florence A. Eldred, *Marketing Specialist.*
 *†C. J. Goodell, B. S., *Assoc. Prof. Agr. Econ.; Asst. Agr. Economist.*
 †J. F. McKay, B. S., *Marketing Specialist (Coop. U. S. D. A.).*
 †T. M. Patterson, M. S., *State Marketing Agt. (Coop. U. S. D. A.).*

Education (Agr.): *V. G. Martin, A. B., *Head of Dept.*

- *E. E. Deen, B. S., *Instr. Agr. Ed.*
 *S. S. Greene, B. S., *Asst. Prof. Agr. Ed.*
 *J. P. Wynne, A. M., *Assoc. Prof. Agr. Ed.*

Engineering (Agr.): *†W. C. Howell, M. S., *Head of Dept.*

- *†J. W. Carpenter, M. S., *Assoc. Prof. Agr. Engin.*
 †J. T. Copeland, *Agr. Engin. Specialist.*
 *R. B. Knight, *Asst. Prof. Agr. Engin.*
 *E. T. Taylor, B. S., *Asst. Prof. Agr. Engin.*

Extension (Admin.): † Director Wilson in charge.

- †J. W. Willis, B. S., *Asst. Ext. Dir. and State Agt. in charge Men's Work.*
 †Susie V. Powell, *Asst. Ext. Dir. and State Home Dem. Agt.*
 †J. E. Tanner, *State Club Agt.*

Extension (Admin.)—Continued.

- †J. M. Dean, B. S., *Asst. in Boys' Club Work.*
 †Buena W. Freeman, B. S., *Asst. State Home Dem. Agt.*
 †F. J. Hurst, B. S., *Asst. in Boys' Club Work (P. O., Jackson).*
 †Ola Jordan, B. S., *Asst. State Home Dem. Agt. in charge of Household Arts.*
 †I. B. Kerlin, B. S., *Asst. in Boys' Club Work.*
 †Elaine E. Massey, *Asst. State Agt. in charge Foods.*

Geology: *†W. C. Morse, M. A., *Prof. Geol.; Geol.*

- *F. E. Vestal, M. S., *Assoc. Prof. Geol.*

Horticulture: *†A. B. McKay, M. S., *Prof. Hort.; Hort.*

- *C. S. Adams, B. S., *Assoc. Prof. Hort.*
 †Lyle Brown, B. S., *Fruit Specialist.*
 †H. W. Fristoe, B. S., *Veg. Specialist in charge Food Preservation.*
 *P. B. Monosmith, *Instr. Hort.*
 *†J. C. C. Price, B. S., *Assoc. Prof. and Research Hort.*

Physics: *H. W. Moody, Ph. D., *Prof. Phys.*

- *G. F. Barnes, A. M., *Assoc. Prof. Phys.*
 *O. P. Hart, A. M., *Asst. Prof. Phys.*
 *R. D. E. Matthews, B. S., *Instr. Phys.*

Veterinary Medicine: *K. U. Jones, V. M. D., *Prof. Vet. Med. (State Vet.).***Zoology and Entomology:** *†R. W. Harned, B. S., *Prof. Zool., Ent.; Ent. (State Ent.).*

- †H. W. Allen, M. S., *Zool.*
 *†R. N. Lobdell, M. S., *Assoc. Prof. Zool.; Zool.*
 *Allen McIntosh, B. S., *Instr. Zool., Ent.*
 *E. W. Stafford, M. S., *Assoc. Prof. Zool., Ent.*

Miscellaneous:

- *††Hugh Critz, B. S., *Agr. Editor and Publicity Work.*

*Whitman Davis, M. S., *Libr.*

*††M. H. Moore, *Secy., Treas.*

Substations: J. R. Ricks, M. S., *Director.*

- Coastal Plains Sta., *P. O., McNeill—S. W. Greene, in charge (Coop. U. S. D. A.).*
 Delta Branch Sta., *P. O., Stoneville—*
W. E. Ayres, M. S., Asst. Dir. and Plant Breeder.
 Holly Springs Branch Sta., *P. O., Holly Springs—*
C. T. Ames, B. S., Asst. Dir.
J. C. Ryan, Farm Foreman.
H. F. Wallace, B. S., Asst. Agron.
 Raymond Branch Sta., *P. O., Raymond—*
C. B. Anders, B. S., Asst. Dir.
J. C. Peyton, Farm Foreman.
 South Miss. Branch Sta., *P. O., Poplarville—*
E. B. Ferris, M. S., Asst. Dir.
W. C. Anderson, Hort.
B. V. Evans, Farm Foreman.

† For subject-matter workers see the respective division, i. e., agronomy, animal industry, etc.

Alcorn Agricultural and Mechanical College, Alcorn.

*Agricultural faculty.

*L. J. Rowan, Ph. D., *President*.

*P. S. Bowles, B. S., *Prof. Agr. Ed.*
 *A. T. Busby, *Prof. Agr., Supt. of Farm.*
 *Sarah P. Holmes, *Prof. Home Econ. Ed.*
 *Selina C. Jackson, *Instr. Nurse Training.*
 *Mrs. B. M. Johnson, *Instr. Housekeeping.*
 *Alice G. Laws, *Instr. Dom. Art.*
 *L. J. McKay, B. S., *Asst. Prof. Agr.*

*W. S. Nelson, *Instr. Laundering.*
 *C. P. Robinson, B. S., M. D., *Prof. Phys., Chem.*
 *O. W. Sanders, B. S., *Asst. Prof. Agr. Voc. Ed.*
 *H. T. Tanner, *Prof. Hort. and Dairying.*
 *J. B. Wright, B. S., *Asst. Prof. Agr. Voc. Ed.*

MISSOURI.

College of Agriculture and the Agricultural Experiment Station of the University of Missouri,¹ Columbia.

*College faculty. †Station staff. ‡Extension staff.

*S. D. Brooks, M. Ped., A. M., LL. D., *President of University.**†F. B. Mumford, M. S., *Dean Coll. of Agr., Dir. of Sta. Prof. An. Husb.*‡A. J. Meyer, B. S., *Dir. of Agr. Ext. Service.*E. J. McCaustland, C. E., M. C. E., *Dean School of Engin., Dir. Engin. Expt. Sta.***Animal Industry:** *†E. A. Trowbridge, B. S.,
*Prof. and Chair. Dept. of An. Husb.**†A. C. Ragsdale, B. S., *Prof. and Chair. Dept. of Dairy Husb.**†H. L. Kempster, B. S., *Prof. and Chair. Dept. of Poultry Husb.**P. M. Bernard, A. M., *Instr. An. Husb.**†Samuel Brody, M. A., *Asst. Prof. Dairy Chem.*‡J. W. Burch, *An. Husb. Specialist.**†D. W. Chittenden, B. S., *Asst. Prof. An. Husb.**M. T. Foster, B. S., *Asst. An. Husb.*‡H. M. Garlock, B. S., *Ext. Asst. Prof. An. Husb.*‡I. G. Gibson, B. S., *Ext. Asst. Prof. Dairy Husb.*‡E. M. Harmon, B. S., *Ext. Asst. Prof. Dairy Husb.**†W. P. Hays, B. S., *Instr. Dairy Husb.**†E. W. Henderson, B. S., *Asst. Prof. Poultry Husb.**†D. H. Nelson, M. S., *Instr. Dairy Husb.*†J. B. Nelson, A. M., *Asst. in Dairy Husb.*‡M. J. Regan, B. S., *Ext. Instr. Dairy Husb.**†W. H. E. Reid, M. S., *Assoc. Prof. Dairy Husb.**M. A. Seaton, *Instr. Poultry Husb.*‡H. L. Shrader, B. S., *Ext. Asst. Prof. Poultry Husb.**†C. W. Turner, A. M., *Instr. Dairy Husb.*‡R. L. Waddell, B. S., *Ext. Asst. Prof. An. Husb.**†L. A. Weaver, B. S., *Prof. An. Husb.*‡Berley Winton, B. S., *Ext. Instr. Poultry Husb.***Botany:** *†W. J. Robbins, Ph. D., *Prof. and Chair. of Dept.**†W. H. Eyster, Ph. D., *Asst. Prof. Bot.**Ruth H. Lindsay, A. M., *Instr. Bot.**W. E. Maneval, Ph. D., *Asst. Prof. Bot.**†I. T. Scott, A. M., *Asst. in Bot.; Asst. Plant Path.***Chemistry (Agr.):** *†A. G. Hogan, Ph. D.,
*Chair. Dept. and Prof. An. Nutr.**†Sidney Calvert, A. M., *Prof. Org. Chem.***Chemistry (Agr.)—Continued.***†L. D. Haigh, Ph. D., *Assoc. Prof. Agr. Chem.*†A. R. Hall, B. S., *Asst. in Agr. Chem.**H. M. Harshaw, M. S., *Instr. Agr. Chem.**J. E. Hunter, *Asst. in Agr. Chem.**†J. L. Nierman, M. A., *Instr. Agr. Chem.**†W. S. Ritchie, Ph. D., *Asst. Prof. Agr. Chem.**Herman Schlundt, Ph. D., *Prof. Chem.**E. E. Vanatta, M. S., *Asst. Prof. Agr. Chem.***Economics (Rural):** *†O. R. Johnson, A. M.,
*Prof. Farm Mgt. and Chair. Dept. of Rural Life.**†E. L. Morgan, A. M., *Prof. Rural Sociol.**†D. R. Cowan, Ph. D., *Asst. Prof. Marketing.**†B. H. Frame, B. S., *Instr. Farm Mgt.**†S. D. Gromer, A. M., *Assoc. Prof. Rural Econ.*‡H. C. Hensley, B. S., *Ext. Asst. Prof. Agr. Econ.*‡B. L. Hummel, B. S., *Ext. Instr. Rural Sociol.**†W. L. Witte, M. A., *Asst. Prof. Rural Sociol.***Education (Agr.):** *†T. E. Sexauer, M. S., *Prof. Agr. Ed.**J. V. Ankeney, B. S., *Assoc. Prof. Visual Instruction and Itinerant Teaching.***Engineering (Agr.):** *†J. C. Wooley, B. S., *Prof. and Chair. of Dept.**†W. C. Boney, B. S., *Asst. in Agr. Engin.**†M. M. Jones, B. S., *Asst. Prof. Agr. Engin.***Entomology:** *†Leonard Haseman, Ph. D.,
*Prof. and Chair. of Dept. Chief Nursery Insp.**†K. C. Sullivan, A. M., *Asst. Prof. Ent. Deputy Nursery Insp.**Neely Turner, B. S., *Asst. in Ent. Deputy Nursery Insp.*†Otis Wade, M. S., *Ext. Asst. Prof. Ent.***Extension (Admin.):**² Director Meyer in charge.†R. H. Emberson, B. S., *State Ext. Agt.*†C. C. Hearne, *State Ext. Agt.*‡Jane Hinote, *Boys' and Girls' Club Agt.*†T. T. Martin, A. B., *Boys' and Girls' Club Agt.*†P. B. Naylor, A. B., *State Ext. Agt.*†J. F. Nicholson, M. S., *State Ext. Agt.*¹ This institution gives the academic title to all employees.² For subject-matter workers see the respective division, i. e., animal industry, botany, etc.

Extension (Admin.)—Continued.†Addie D. Root, B. S., *State Ext. Agt.*†R. R. Thomasson, B. S., *State Ext. Agt.***Field Crops:** *†W. C. Etheridge, Ph. D., *Prof. and Chair. of Dept.*†C. E. Carter, B. S., *Ext. Asst. Prof. Field Crops.*†D. W. Frear, M. S., *Ext. Assoc. Prof. Field Crops.*†K. G. Harmon, B. S., *Ext. Instr. Field Crops.**†C. A. Helm, A. M., *Assoc. Prof. Field Crops.**†R. T. Kirkpatrick, B. S., *Instr. Field Crops.**†O. W. Letson, A. M., *Instr. Field Crops.**†L. J. Stadler, Ph. D., *Asst. Prof. Field Crops.***Geology:** *E. B. Branson, Ph. D., *Prof. and Chair. of Dept.**W. A. Tarr, Ph. D., *Prof. Geol.***Home Economics:** *Jessie A. Cline, B. S., *Assoc. Prof. and Chair. of Dept.**Florence B. Caton, A. M., *Instr. Home Econ.*†Ida F. Clark, B. S., *Ext. Asst. Prof. Home Econ.**Rosalie Godfrey, B. S., *Asst. Prof. Home Econ.**Gertrude Heinrici, *Instr. Home Econ.*†Essie M. Heyle, B. S., Ph. B., *Ext. Prof. Home Econ.**Mary L. Klingner, A. M., *Asst. Prof. Home Econ.*†Lois Martin, B. S., *Ext. Instr. Home Econ.*†Mary E. Robinson, B. S., *Ext. Asst. Prof. Home Econ.*†Julia M. Rochefort, Pe. B., *Ext. Instr. Home Econ.**Minnola Stallings, R. N., *Instr. Home Econ.**Hannah A. Stillman, A. M., *Instr. Home Econ.**Lila Welsh, M. A., *Asst. Prof. Home Econ.**Bertha K. Whipple, M. A., *Asst. Prof. Home Econ.**Mrs. Anna B. Williams, B. S., *Instr. Home Econ.***Horticulture:** *†T. J. Talbert, A. M., *Prof. and Chair. of Dept.*†A. P. Boles, M. A., *Ext. Asst. Prof. Hort.**†A. M. Burroughs, M. S., *Instr. Hort.**E. Honeywell, *Instr. Hort.**†H. D. Hooker, jr., Ph. D., *Assoc. Prof. Hort.**H. F. Major, B. S., *Assoc. Prof. Landsc. Gard. and Supt. of Grounds.***Horticulture—Continued.**†E. M. Page, B. S., *Ext. Asst. Prof. Hort.**†J. T. Quinn, B. S., *Instr. Hort.**†H. G. Swartwout, B. S., *Instr. Hort.***Physics:** *H. M. Reese, Ph. D., *Prof. and Chair. of Dept.**O. M. Stewart, Ph. D., *Prof. Phys.***Soils:** *†M. F. Miller, M. S., *Prof. and Chair. of Dept.**†W. A. Albrecht, Ph. D., *Assoc. Prof. Soils.**†Richard Bradford, Ph. D., *Asst. Prof. Soils.**†B. B. Branstetter, B. S., *Instr. Soils and Field Crops.*†William DeYoung, B. S., *Asst. in Soil Survey.*†C. L. Dietz, B. S., *Ext. Asst. Prof. Soils.**†F. L. Duley, Ph. D., *Assoc. Prof. Soils.*†H. V. Jordan, B. S., *Asst. in Soil Survey.**†H. H. Krusekopf, A. M., *Prof. Soils, Soil Survey Work.**†E. B. Powell, B. S., *Asst. in Soils.*†P. F. Schowengerdt, B. S., *Ext. Assoc. Prof. Soils.*†R. J. Silkett, B. S., *Ext. Instr. Soils.*†I. P. Trotter, M. S., *Ext. Asst. Prof. Crops and Soils.*†R. E. Uhlund, B. S., *Asst. in Soils.***Veterinary Science:** *†J. W. Connaway, D. V. S., M. D., *Chair. of Dept., Prof. Vet. and Comp. Med.**†L. S. Backus, D. V. M., *Assoc. Prof. Vet. Sci.*†O. S. Crisler, D. V. M., *Supt. Serum Plant.**†A. J. Durant, A. M., *Asst. Prof. Vet. Sci.**†H. G. Newman, A. M., *Instr. Vet. Sci.***Zoology:** *W. C. Curtis, Ph. D., *Prof. and Chair. of Dept.**†W. R. B. Robertson, Ph. D., *Assoc. Prof. Zool.**G. W. Tannreuther, Ph. D., *Assoc. Prof. Zool.***Miscellaneous:**†J. F. Barham, *Photog.**†Leslie Cowan, B. S., *Secy.**†Jane Frodsham, *in charge Agr. Libr.*††A. A. Jeffrey, A. B., *Agr. Editor.**†R. B. Price, jr., *Treas.**George Reeder, *Lect. on Met. and Climat., Dir. Mo. Climatic Service, Met. U. S. Weather Bureau.**†S. B. Shirky, A. M., *Supt. Short Courses, Asst. to Dean and to Dir. of Sta.***Missouri State Fruit Experiment Station, Mountain Grove.**

†Station staff.

†F. W. Faurot, B. S., *Director.*†J. W. Hitt, *Mgr.*†C. R. Phipps, B. S., *Ent.***Missouri State Poultry Experiment Station, Mountain Grove.**

†Station staff.

†T. W. Noland, *Director.*†Ethel Byer, *Asst. Secy.*†Noel Hall, *Specialist in Poultry Ext.*†Sivert Eriksen, D. V. M., *Path. and Bact.*†W. A. Hovis, *Lab. Tech.***Lincoln University, Jefferson City.**

*Agricultural faculty.

*N. B. Young, A. M., Litt. D., *President.**Helen G. Crampton, *Dom. Art.**H. M. Hunter, B. S., *Agr.**J. W. Damel, M. Ph., *Biol.**W. B. Jason, M. A., *Phys. and Chem.**B. M. Hawkins, *Dom. Sci.**Anna L. Porter, B. S., *Chem.*

MONTANA.

Montana State College of Agriculture and Mechanic Arts and the Agricultural Experiment Station, Bozeman.

*College faculty. †Station staff. ‡Extension staff.

*Alfred Atkinson, D. Sc., *President*.*†F. B. Linfield, B. S. A., *Dean of Agr., Dir. of Sta.*‡F. S. Cooley, B. S., *Dir. of Ext. Service.*E. B. Norris, M. E., *Dean of Engin.***Agronomy:** *†Clyde McKee, B. S., *Head of Dept.*†L. F. Gieseke, M. S., *Asst.**†I. J. Jensen, B. S., *Asst. Prof. and Asst. Agron.*†A. J. Ogaard, B. S., *Agron. Specialist.***Animal Industry:** *††C. N. Arnett, B. S., *Head Dept. of An. Husb. Vice Dean of Agr.**† ———, *Head Dept. of Poultry Husb.*†Harriette E. Cushman, B. S., *Poultry Specialist.**†E. J. Haslerud, B. S., *Instr. and Asst. An. Husb.**†W. E. Joseph, Ph. D., *Assoc. Prof. and Asst. An. Husb.**R. C. McChord, B. S., *Assoc. Prof. An. Husb.**A. L. McMahon, B. S., *Instr. An. Husb.*†R. B. Millin, B. S., *Livestock Specialist.**J. A. Nelson, M. S., *Instr. Dairy Husb.*†J. O. Tretsven, B. S., *Dairy Specialist.***Botany and Bacteriology:** *†D. B. Swingle, M. S., *Head of Dept.**W. N. Christopher, B. S., *Asst. Bot. and Bact. (Coop. U. S. D. A.).*†H. E. Morris, M. S., *Assoc. Bot. and Bact.***Chemistry:** †Edmund Burke, B. S., *Chem. and Met.**W. M. Cobleigh, E. M., A. M., *Prof. Chem. and Chem. Engin. (State Chem.).*†S. G. Scott, B. S., *Asst. Chem.*†P. F. Sharp, Ph. D., *Asst. Chem.***Education (Agr.):** *M. J. Abbey, A. B., *Prof. Agr. Ed.***Engineering (Agr.):** *†H. E. Murdock, C. E., M. E., *Head of Dept.**†J. R. Barker, B. S., *Instr. and Asst. in Agr. Engin.**F. L. Griffin, *Instr. Agr. Engin.**R. M. Merrill, B. S., *Instr. Agr. Engin.***Entomology:** *†R. A. Cooley, B. S., *Head of Dept. (State Ent.).*†W. C. Cook, Ph. D., *Asst. in Ent.*†J. R. Parker, Ph. D., *Assoc. Ent.**O. A. Sippel, B. S., *Instr. Beekeeping.***Extension (Admin.):** † Director Cooley in charge.†J. C. Taylor, B. S., *County Agt. Leader.*†Blanche L. Lee, B. S., *State Home Dem. Leader.*†C. E. Potter, B. S., *State Club Leader.*†Gertrude Hoffman, *Asst. State Home Dem. Leader.*†Doris Ingram, *Asst. State Club Leader.***Extension (Admin.)—Continued.**†E. H. Lott, B. S., *Asst. County Agt. Leader.***Farm Management and Economics:** *†E. L. Currier, B. S., *Prof. Farm Mgt.**J. M. Hamilton, M. S., *Agr. Economist.**†H. E. Selby, B. S., *Asst. Prof. and Asst. in Farm Mgt.*†M. L. Wilson, M. S., *Farm Mgt. Dem.***Home Economics:** *Gladys A. Branegan, M. S., *Prof. Home Econ.**Florence Fallgatter, B. S., *Asst. Prof. Home Econ.*†Martha M. Hunter, A. B., *Food and Nutr. Specialist.**Agnes E. Hutchinson, B. S., *Instr. Home Econ.*†Inez La Bossier, B. S., *Clothing Specialist.**Mirdyaleen Maxwell, M. S., *Asst. Prof. Institutional Mgt.**Alice H. Metcalf, M. S., *Instr. Home Econ.***Horticulture:** *†F. M. Harrington, M. S., *Head of Dept.**†C. C. Starring, B. S., *Asst. Prof. and Asst. Hort.***Veterinary Science:** *†Howard Welch, D. V. M., *Head of Dept.**†W. J. Hall, D. V. M., *Asst. in Vet. Sci.***Zoology:** *M. H. Spaulding, A. M., *Asst. Prof. and Head of Dept.***Miscellaneous:***†R. B. Bowden, *Editorial Dir.**††John Dexter, *Asst. Editorial Dir.**Elizabeth Forrest, B. L. S., A. M., *Libr.*†J. G. Rodriguez, *Seed Analyst and Asst. in Grain Lab.*†W. O. Whitecomb, M. S., *Supt. of Grain Lab.***Substations:**Hort. Substa., *P. O., Victor*—Harvey Thornber, B. S., *Supt.*Huntley Substa., *P. O., Huntley*—Dan Hansen, *Supt. (Coop. U. S. D. A.).*A. E. Seamans, B. S., *Asst. Supt.*Judith Basin Substa., *P. O., Moccasin*—Albert Osenberg, B. S., *Actg. Supt. (Coop. U. S. D. A.).*Northern Mont. Substa., *P. O., Havre*—G. W. Morgan, B. S., *Supt. (Coop. U. S. D. A.).*A. L. Baker, B. S., *Asst. in An. Husb. (Coop. U. S. D. A.).*

† For subject-matter workers see the respective division, i. e., agronomy, animal industry, etc.

NEBRASKA.

College of Agriculture and the Agricultural Experiment Station of the University of Nebraska,
Lincoln.

*College faculty. †Station staff. ‡Extension staff.

*Samuel Avery, Ph. D., LL. D., *Chancellor of University.*

*†E. A. Burnett, D. Sc., *Dean Coll. of Agr., Dir. of Sta.*

†W. H. Brokaw, *Dir. of Agr. Ext. Service.*

O. J. Ferguson, M. E. E., *Dean Coll. of Engin.*

Agronomy: *†W. W. Burr, B. S., *Chair. of Dept. and Asst. Dir. of Sta.*

*†T. A. Kiesselbach, Ph. D., *Prof. Agron.; Agron.*

†Arthur Anderson, M. S., *Asst. Agron. and Supt. Agron. Farm.*

*T. H. Goodding, M. S., *Asst. Prof. Agron.*

†D. L. Gross, B. S., *Asst. State Agt. in Agron.*

*F. D. Keim, M. S., *Prof. Agron.*

†W. E. Lyness, B. S., *Asst. Agron.*

*†J. C. Russel, M. S., *Assoc. Prof. and Assoc. Agron.*

†P. H. Stewart, B. S., *State Agt. in Agron.*

Animal Industry: *†H. J. Gramlich, B. S., *Chair. Dept. of An. Husb.*

*†H. P. Davis, M. S., *Chair. Dept. of Dairy Husb.*

*†F. E. Mussehl, B. S., *Prof. Poultry Husb.; Poultry Husb.*

*†E. O. Anderson, M. S., *Instr. and Asst. Dairy Husb.*

*R. A. Braun, B. S., *Instr. Dairy Husb.*

*W. W. Derrick, B. S., *Instr. An. Husb.*

*†P. A. Downs, Ph. D., *Asst. Prof. and Assoc. Dairy Husb.*

*†H. D. Fox, M. S., *Instr. and Asst. Dairy Husb.*

†M. N. Lawritson, B. S., *State Agt. in Dairy Husb.*

*†W. J. Loeffel, B. S., *Assoc. Prof. An. Husb.; in charge Swine Invest.*

*†R. F. Morgan, B. S., *Instr. and Asst. Dairy Husb.*

†M. B. Posson, B. S., *State Agt. in An. Husb.*

†O. N. Summers, B. S., *State Agt. in Poultry Husb.*

Botany: *†R. J. Pool, Ph. D., *Chair. of Dept.*

*†G. L. Peltier, Ph. D., *Prof. Plant Path.; Plant Path.*

*Emma N. Andersen, A. M., *Asst. Prof. Bot.*

*†R. W. Goss, M. S., *Asst. Prof. and Asst. Plant Path.*

*Leva B. Walker, A. M., *Assoc. Prof. Bot.*

*J. E. Weaver, Ph. D., *Prof. Plant Ecology.*

Chemistry: *†F. W. Upson, Ph. D., *Chair. of Dept.*

*†M. J. Blish, Ph. D., *Prof. Agr. Chem.; Chem.*

*R. C. Abbott, A. M., *Instr. Chem.*

*C. W. Anderson, M. S., *Asst. Chem.*

†R. M. Sandstedt, M. S., *Asst. Chem.*

*†T. J. Thompson, Ph. D., *Asst. Prof. Chem.*

Economics (Rural): *†H. C. Filley, A. M., *Chair. of Dept.*

†G. R. Boomer, *State Agt. in Marketing.*

†N. W. Gaines, B. S., *State Agt. in Community Organ.*

*A. W. Medlar, A. M., *Asst. Prof. Rural Econ.*

*†J. O. Rankin, A. M., *Assoc. Prof. and Assoc. in Rural Econ. (Coop. U. S. D. A.).*

Economics (Rural)—Continued.

†E. L. Taylor, B. S., *State Agt. in Farm Mgt.*

Education (Agr.): *H. E. Bradford, A. M., *Chair. of Dept., Prin. School of Agr.*

*Beulah I. Coon, B. S., *Asst. Prof. Voc. Ed.*

*Helen H. Halm, B. S., *Asst. Prof. Voc. Ed.*

*C. C. Minter, A. M., *Asst. Prof. Agr. Ed.*

Engineering (Agr.): *†O. W. Sjogren, B. S. A. E., *Chair. of Dept.*

*E. E. Brackett, B. S. E. E., *Prof. Agr. Engin.*

*A. A. Baer, B. A., *Assoc. Prof. Agr. Engin.*

†F. R. Nohavee, B. S., *Tractor Testing Engin.*

*J. D. Parsons, B. S. M. E., *Asst. Prof. Agr. Engin.*

*W. J. Runnalls, *Instructing Mechanic.*

*C. W. Smith, M. S., *Assoc. Prof. Agr. Engin.*

†I. D. Wood, M. S., *State Agt. in Agr. Engin.*

Entomology: *†M. H. Swenk, A. M., *Chair. of Dept. (State Ent.).*

*†E. E. Wehr, M. S., *Instr. and Asst. Ent.*

*†D. B. Whelan, M. S., *Instr. and Asst. Ent.*

Extension (Admin.): †Director Brokaw in charge.

†Mary-Ellen Brown, B. S., *State Agt. in Women's Work.*

†L. I. Frisbie, B. S., *State Agt. in Club Work.*

†C. W. Jones, B. S., *Asst. State Agt. in Club Work.*

†L. T. Skinner, B. S., *Secy.*

†Allegra Wilkins, *Asst. State Agt. in Club Work.*

†H. J. Young, B. S., *Routing and Reports.*

Home Economics: *Margaret S. Fedde, A. B., *Chair. of Dept.*

†Florence J. Atwood, B. S., *State Agt. in Foods and Nutr.*

*Alice H. Bradt, A. M., *Instr. Home Econ.*

*Frances Dunning, B. S., *Instr. Home Econ.*

†Myrtle Easley, B. S., *State Agt. in Clothing.*

†M. Olive Howey, B. S., *Asst. State Agt. in Clothing.*

†Jessie G. Greene, B. S., *Asst. State Agt. in Foods and Nutr.*

*Arabella S. Livingston, B. S., *Instr. Home Econ.*

†Edith Martin, *State Agt. in Home Health and Hyg.*

*Grace M. Morton, A. B., *Asst. Prof. Home Econ.*

*Matilda K. Peters, B. S., *Instr. Home Econ.*

*Mrs. Margaret A. Rice, *Instr. Home Econ.*

*Elizabeth Rutherford, Ph. B., *Instr. Home Econ.*

*Ruth Staples, B. S., *Instr. Home Econ.*

*Bess Steele, *Instr. Home Econ.*

*Jean J. Stewart, M. A., *Asst. Prof. Home Econ.*

*Maude Vedder, B. S., *Instr. Home Econ.*

¹ In charge of all substations.

² For subject-matter workers see the respective division, i. e., agronomy, animal industry, etc.

Horticulture: *†R. F. Howard, M. A., *Chair. of Dept.*
 †E. H. Hoppert, B. S., *State Agt. in Hort.*
 *†H. O. Werner, M. S., *Assoc. Hort.*
 *†C. C. Wiggans, Ph. D., *Assoc. Prof. and Assoc. Hort.*

Meteorology: *†G. A. Loveland, A. M., LL. B., *Prof. Met.; Met.*

Veterinary Science: *†Leunis Van Es, M. D., V. S., *Chair. Dept. of An. Path. and Hyg.*
 †S. W. Alford, D. V. S., *Supt. Anti-Hog Cholera Serum Plant.*
 *†H. M. Martin, V. M. D., A. M., *Asst. Prof. An. Path. and Hyg.; Asst. Vet.*
 *L. V. Skidmore, B. S., D. V. M., *Instr. An. Path.*

Miscellaneous:

*†R. P. Crawford, B. A., *Agr. Editor.*
 *†L. E. Gunderson, *Finance Secy.*
 *†Edna C. Noble, B. L., *Asst. in charge Libr.*
 *S. W. Perin, *Farm Supt.*

Substations: E. A. Burnett, D. Sc., *in charge.*

North Platte Substa., P. O., *North Platte*—
 W. P. Snyder, M. S., *Supt.*
 L. L. Zook, B. S., *Agron. (Coop. U. S. D. A.).*
 Scottsbluff Substa., P. O., *Mitchell*—J. A. Holden,
 B. S., *Supt.*
 Valentine Substa., P. O., *Valentine*—E. M.
 Brouse, B. S., *Supt.*

NEVADA.**College of Agriculture and the Agricultural Experiment Station of the University of Nevada, Reno.**

*College faculty. †Station staff. ‡Extension staff.

*W. E. Clark, Ph. D., LL. D., *President of University.*
 *†Robert Stewart, Ph. D., *Dean Coll. of Agr.*
 *†S. B. Doten, M. A., *Dir. of Sta. Prof. of Agr. Research; Ent.*
 *†C. W. Creel, B. S., *Dir. of Agr. Ext. Prof. of Agr. Ext.*
 F. H. Sibley, M. E., *Dean Coll. of Engin.*

Agronomy: Dean Stewart *in charge and Specialist in Soils.*

*†George Hardman, M. S., *Asst. Prof. Agron.: Asst. in Irrig.*

Animal Industry: *†F. W. Wilson, M. S., *Prof. An. Husb. and Livestock Specialist.*

*†V. E. Scott, B. S., *Prof. Dairying and Poultry.*
 †C. E. Fleming, B. S., *Range Mgt.*

Biology: *Peter †ransden, A. M., *Prof. Biol.*

*C. L. Brown, A. M., *Instr. Biol.*
 *P. A. Lehenbauer, Ph. D., *Assoc. Prof. Biol.*
 *Margaret E. Mack, A. M., *Assoc. Prof. Biol.*

Chemistry: *Maxwell Adams, Ph. D., *Prof. Chem.*

†M. R. Miller, B. S., *Chem.*
 *Ruth A. Billinghamurst, B. A., *Instr. Chem.*
 *W. M. Hoskins, Ph. D., *Instr. Chem.*
 *G. W. Sears, Ph. D., *Assoc. Prof. Chem.*

Education (Agr.): *G. W. Barr, M. S., *Asst. Prof. Agr. Ed.***Engineering (Agr.):** †F. L. Bixby, C. E., *Irrig. (Coop. U. S. D. A.).***Extension (Admin.):** † Director Creel *in charge.*

*†R. G. Foster, B. S., *Assoc. Prof. and Asst. Dir. of Ext.*

*†Mary E. Stillwell, B. S., *Assoc. Prof. and Asst. Dir. of Ext.*

Home Economics: *Sarah L. Lewis, B. S., *Prof. Home Econ.*

*Mrs. Luella M. Foster, *State Supt. Home Econ.*
 *Louise K. Hammond, B. S., *Instr. Home Econ.*

*Jessie P. Pope, B. S., *Asst. Prof. Home Econ.*

Physics: *L. W. Hartman, Ph. D., *Prof. Phys.*

*G. B. Blair, *Asst. Prof. Phys.*

Veterinary Science: †Edward Records, V. M. D., *Vet.*

†L. R. Vawter, D. V. M., *Vet. Path.*

Miscellaneous:

†Martha Ryan, *Libr. and Secy.*

NEW HAMPSHIRE.**The College of Agriculture and the Mechanic Arts and the Agricultural Experiment Station of the University of New Hampshire, Durham.**

*College faculty. †Station staff. ‡Extension staff.

*R. D. Hetzel, A. B., LL. D., *President of the University.*

*†F. W. Taylor, B. S., *Dean Coll. of Agr.*

††J. C. Kendall, B. S., *Dir. of Sta., Dir. Ext. Service.*

C. H. Crouch, M. E., *Dean of Coll. of Tech.*

Agronomy: Dean Taylor *in charge.*

*†M. G. Eastman, M. S., *Asst. Prof. and Asst. Agron.*

Animal Industry: *†J. C. McNutt, B. S., *Prof. An. Husb.: An. Husb.*

*†J. M. Fuller, B. S., *Prof. Dairy Husb.; Dairy Husb.*

*†A. W. Richardson, B. S., *Prof. Poultry Husb.; Poultry Husb.*

Animal Industry—Continued.

*†H. F. DePew, B. S., *Asst. Prof. and Asst. Dairy Husb.*

*†P. I. Fitts, B. S., *Instr. and Asst. in Poultry Husb.*

*B. E. Huggins, *Instr. Dairy Husb.*

†E. G. Ritzman, B. S., *An. Brdg. and Nutr.*

*L. V. Tirrell, B. S., *Instr. An. Husb.*

†G. L. Waugh, B. S., *Agt. in Dairying.*

††† For similar matters workers see the respective division, i. e., agronomy, animal industry, etc.

Botany: *†O. R. Butler, Ph. D., *Prof. Bot.*; *Bot.*

*Mabel Brown, Ph. D., *Asst. Prof. Bot.*

*†L. J. Klotz, Ph. D., *Asst. Prof. and Asst. Bot.*

Chemistry: *†H. R. Kraybill, Ph. D., *Prof. Agr. Chem.*; *Chem.*

*Charles James, F. I. C., *Prof. Chem.*

*H. C. Fogg, M. S., *Instr. Chem.*

*W. S. Frost, Ph. D., *Asst. Prof. Chem.*

*G. A. Perley, A. M., *Assoc. Prof. Chem.*

*M. M. Smith, A. M., *Asst. Prof. Chem.*

†T. O. Smith, M. S., *Assoc. Chem.*

*†C. P. Spaeth, M. S., *Instr. and Asst. Chem.*

Education (Agr.): *Hollie L. Whitemore, B. S., *Instr. Agr. Ed.*

Entomology: *†W. C. O'Kane, M. A., *Prof. Econ. Ent.*; *Ent. (State Nursery Insp.)*

*†P. R. Lowry, M. S., *Asst. Prof. Econ. Ent.*; *Asst. Ent.*

Extension (Admin.): †Director Kendall in charge.

†E. P. Robinson, B. S., *County Agt. Leader.*

†Daisy D. Williamson, *State Home Dem. Leader.*

†C. B. Wadleigh, B. S., *State Club Leader.*

†Ann F. Beggs, *Asst. State Home Dem. Leader.*

†Mary L. Sanborn, *Asst. State Club Leader.*

†H. C. Woodworth, M. S., *Farm Mgt. Dem.*

Forestry: *†K. W. Woodward, M. F., *Prof. For.*; *For.*

*C. L. Stevens, B. S., *Asst. Prof. For.*

Home Economics: *Mrs. Helen F. McLaughlin, B. S., *Prof. and Head of Dept.*

*Emma A. Baie, B. S., *Assoc. Prof. Home Econ.*

*Irma G. Bowen, *Instr. Household Arts.*

Horticulture: *†G. F. Potter, M. S., *Prof. Hort.*; *Hort.*

*†J. R. Hepler, M. S., *Asst. Prof. and Asst. in Veg. Gard.*

*†James Macfarlane, *Instr. Flor.*; *Florist.*

*†S. W. Wentworth, B. S., *Asst. Prof. and Asst. Hort.*

Physic: *H. L. Howes, Ph. D., *Prof. Phys.*

*Clement Moran, A. B., *Asst. Prof. Phys.*

*R. R. Starke, A. B., *Instr. Phys.*

Zoology: *C. F. Jackson, M. S., *Prof. Zool.*

*H. M. Emery, B. S., *Instr. Zool. and Geol.*

*Alma D. Jackson, M. A., *Instr. Zool.*

Miscellaneous:

*†W. P. Lewis, B. L. S., M. A., *Libr.*

†A. D. Littlehale, *Shepherd.*

††Elizabeth E. Mehafeey, *Asst. Libr.*

††H. B. Stevens, A. B., *Editorial and Executive Secy.*

NEW JERSEY.

State College of Agriculture and Mechanic Arts and the Agricultural Experiment Station of Rutgers College and the State University of New Jersey, *New Brunswick.*

*College faculty. †Station staff. ‡Extension staff.

*W. H. S. Demarest, A. M., D. D., LL. D., *President.*

*†J. G. Lipman, Ph. D., D. Sc., *Dean of Agr. and Dir of Sta. Prof. of Agr.; Soil Chem., Bact.*

†H. J. Baker, B. S., *Dir. Div. of Ext. in Agr. and Home Econ.*

E. H. Rockwell, C. E., *Dean of Engin.*

Agronomy and Soil Chemistry: *†A. W. Blair, A. M., *Prof. Agron., Agr. Chem.; Agron., Soil Chem.*

†H. R. Cox, M. S., *Agron. Specialist.*

†J. S. Joffe, Ph. D., *Research Asst. in Soils.*

*†G. W. Musgrave, M. S., *Assoc. Prof. and Assoc. Agron.*

†A. L. Prince, M. S., *Asst. Soil Chem.*

*†H. B. Sprague, M. S., *Instr. and Asst. in Agron.*

†S. A. Waksman, Ph. D., *Microbiol., Soil Research.*

Animal Industry: *F. G. Helyar, B. S., *Prof. An. Husb. and Dir. of Short Courses.*

*W. C. Thompson, B. S., *Prof. Poultry Husb.*

*†J. W. Bartlett, B. S., *Asst. Prof. Dairy Husb., Dairy Husb.*

†W. H. Allen, B. S., *Poultry Specialist.*

*†F. R. Beaudette, D. V. M., *Asst. Prof. and Asst. Poultry Path.*

*F. C. Button, B. S., *Asst. Prof. Dairy Husb.*

*†N. R. Mehrhof, B. S., *Asst. Prof. Poultry Husb.*

†E. J. Perry, B. S., *Dairy Specialist.*

*W. C. Skelley, M. S., *Asst. Prof. An. Husb.*

*W. P. Thorp, Jr., B. S., *Instr. Poultry Husb.*

Bacteriology: *†T. J. Murray, M. S., *Assoc. Prof. Bact.*

†R. L. Starkey, M. S., *Research Bact.*

Botany and Plant Pathology: *†J. W. Shive, Ph. D., *Chief Div. of Bot.; Plant Physiol.*

*M. A. Chrysler, Ph. D., *Assoc. Prof. Bot.*

Botany and Plant Pathology—Continued.

†J. G. Gaines, B. S., *Research Asst. in Plant Path.*

*A. P. Kelley, Ph. D., *Instr. Bot.*

†S. Lomanitz, M. S., *Research Asst. in Plant Physiol.*

†R. P. Marsh, M. S., *Research Asst. in Plant Physiol.*

*†W. H. Martin, Ph. D., *Asst. Prof. Plant Path.; Plant Path.*

†R. F. Poole, Ph. D., *Assoc. Plant Path.*

Chemistry: *R. G. Wright, Ph. D., *Prof. Chem.*

*A. C. de Regt, M. S., *Assoc. Prof. Chem.*

*Ernest Little, M. S., *Assoc. Prof. Chem.*

*W. A. Lott, M. S., *Instr. Chem.*

*E. L. Sargent, M. S., *Instr. Chem.*

*P. A. van der Meulen, Ph. D., *Assoc. Prof. Chem.*

Economics (Agr.): *†Henry Keller, Jr., M. S., *Asst. Prof. and Agr. Economist.*

†W. F. Knowles, A. B., *Agr. Econ. Specialist.*

*F. L. Manning, *Asst. in Agr. Econ.*

Education (Agr.): *H. O. Sampson, A. M., *Prof. Agr. Ed.*

*H. B. Allen, B. S., *Asst. in Agr. Ed.*

*E. V. Bearer, M. S., *Instr. Agr. Ed.*

Engineering (Rural): *E. R. Gross, B. S., *Prof. Rural Engin.*

*D. B. Lucas, M. S., *Instr. Rural Engin.*

† For subject-matter workers see the respective division, i. e., agronomy, animal industry, etc.

Entomology: *†T. J. Headlee, Ph. D., *Prof. Ent.; Ent. (State Ent.)*.

*†Alvah Peterson, Ph. D., *Assoc. Prof. and Assoc. Ent.*

†Carl Ilg, *Lab. Asst. in Ent.*

Extension (Admin.):¹ Director Baker in charge.

†I. L. Owen, B. S., *County Agt. Leader and State Supt. of Farm Dem.*

†Marian Butters, B. S., *State Home Dem. Leader.*

†A. M. Hulbert, *State Leader Junior Ext. Work.*

†Adaline G. Ely, *Asst. State Home Dem. Leader.*

†M. Ethel Jones, M. A., *Asst. State Leader Junior Ext. Work.*

†Mary M. Leaming, *Asst. in Junior Ext. Work.*

†Charles Oliver, *Club Agt. at Large.*

Geology: *J. V. Lewis, S. B., *Prof. Geol.*

Home Economics:² *Mrs. Martha H. French, A. B., *Assoc. Prof. Home Econ.*

†Marie C. Doermann, B. S., *Nutr. Specialist.*

†Mrs. Catherine H. Griebel, *Clothing Specialist.*

†Mrs. Ida S. Harrington, *Home Mgt. Specialist.*

*Alta M. Kelley, B. S., *Instr. Home Econ.*

*Mary I. Raven, M. S., *Asst. Prof. Home Econ.*

*Florence E. Wagner, B. S., *Instr. Home Econ.*

Horticulture: *†M. A. Blake, B. S., *Prof. and Chief Div. of Hort.*

*†J. H. Clark, M. S., *Instr. and Asst. Pomol.*

*A. J. Farley, B. S., *Assoc. Prof. Hort.*

*†H. F. Huber, B. S., *Instr. Veg. Gard.; Asst. in Oler.*

†A. F. Mason, M. S., *Fruit Growing Specialist.*

†C. H. Nissley, B. S., *Veg. Growing Specialist.*

*L. G. Schermerhorn, B. S., *Assoc. Prof. Veg. Gard.*

Physics: *George Winchester, Ph. D., *Prof. Phys.*

*F. R. Pratt, Ph. D., *Prof. Phys.*

Zoology: *W. J. Crozier, Ph. D., *Prof. Zool., Sanitary Sci.*

*T. A. Devan, M. D., *Prof. Hyg.*

*L. A. Hausman, Ph. D., *Asst. Prof. Zool.*

*A. R. Moore, Ph. D., *Prof. Physiol.*

*T. C. Nelson, Ph. D., *Assoc. Prof. Zool.*

*Willem Rudolfs, Ph. D., *Instr. Zool.*

Miscellaneous:

††R. W. DeBaun, B. S., *Asst. Editor.*

†F. A. Hall, B. S., *Asst. to Dir. of Sta.*

*G. A. Osborn, A. M., *Libr.*

*††C. R. Woodward, M. A., *Secy., Editor.*

New Jersey State Agricultural Experiment Station, New Brunswick.

†Station staff.

†J. G. Lipman, Ph. D., D. Sc., *Dir. of Station.*

Agronomy: †G. W. Musgrave, M. S., *Assoc. Agron.*

†H. B. Sprague, M. S., *Asst. Agron.*

Animal Industry: †F. G. Helyar, B. S., *An. Husb.*

†J. W. Bartlett, B. S., *Dairy Husb.*

†W. C. Thompson, B. S., *Poultry Husb.*

†G. I. Ball, *Dairy Insp.*

†F. C. Button, B. S., *Asst. Dairy Husb.*

†Roland Chamberlain, B. S., *Research Asst. in Dairy Husb.*

†R. R. Hannas, M. S., *Supt. Egg Laying Contests.*

†G. H. Pound, B. S., *Asst. in Poultry Research.*

†W. R. Robbers, *Supt. Advanced Registry.*

†W. C. Skelley, M. S., *Asst. An. Husb.*

†W. P. Thorp, jr., B. S., *Asst. in Poultry Research.*

Bacteriology: †H. C. McLean, Ph. D., *Soil Bact.*

†H. N. Heukelekian, B. S., *Asst. in Soil Bact.*

†Margaret Hotchkiss, Ph. D., *Bact. in Sewage Invest.*

†R. L. Starkey, M. S., *Research Asst. in Soils.*

Chemistry: †C. S. Cathcart, M. S., *Chem. (State Chem.)*.

†F. S. Beckwith, B. S., *Fert. and Feed Sampler.*

†F. L. Campbell, B. S., *Chem. in Sewage Invest.*

†L. J. Faneuf, B. S., *Asst. Chem.*

†G. J. Oldis, *Fert. Sampler.*

†A. C. Wark, *Asst. Chem.*

†R. L. Willis, B. S., *Asst. Chem.*

Economics (Agr.): †Henry Keller, jr., M. S., *Agr. Economist.*

†J. S. Hathcock, M. S., *Asst. Fin. Agr. Econ.*

†A. G. Waller, M. S., *Farm Mgt. Research.*

Entomology: †T. J. Headlee, Ph. D., *Ent. (State Ent.)*.

†Willem Rudolfs, Ph. D., *Biochem. in Ent., Chief in Sewage Invest.*

¹ For subject-matter workers see the respective division, i. e., agronomy, animal industry, etc.

² Given in the College for Women.

Entomology—Continued.

†C. S. Beckwith, B. S., *Asst. Ent. (Cranberry Invest.)*.

†L. A. Hausman, Ph. D., *Research Zool. in Sewage Invest.*

†Ray Hutson, B. S., *Asst. Ent. in Apiculture.*

†J. B. Lackey, M. A., *Research Zool. in Sewage Invest.*

†W. N. Walden, *Asst. Ent.*

Horticulture: †M. A. Blake, B. S., *Hort.*

†H. M. Biekart, *Florist.*

†J. H. Clark, B. S., *Asst. Pomol.*

†C. H. Connors, B. S., *Assoc. in Plant Brdg.*

†A. J. Farley, B. S., *Pomol.*

†H. F. Huber, B. S., *Asst. Oler.*

†W. R. Robbins, B. S., *Research Asst. in Veg. Gard.*

Plant Pathology: †W. H. Martin, Ph. D., *Plant Path.*

†L. G. Campbell, *Field Asst. in Plant Path.*

†Elizabeth Clark, B. S., *Research Asst. in Plant Path.*

†C. M. Haenseler, Ph. D., *Plant Brdg. Specialist.*

†R. F. Poole, Ph. D., *Assoc. Plant Path.*

Seed Analysis: †Jessie G. Fiske, M. S., *Seed Analyst.*

†Bonnie R. Fudge, B. S., *Asst. Seed Analyst.*

†J. M. Ginsberg, M. S., *Asst. Seed Analyst.*

†David Schmidt, Ph. D., *Asst. Seed Analyst.*

Zoology: †T. C. Nelson, Ph. D., *Biol. in Oyster Invest.*

Miscellaneous:

†R. W. DeBaun, B. S., *Asst. Editor.*

†C. A. Doehlert, B. S., *Asst. Editor.*

†F. A. Hall, B. S., *Asst. to Dir. of Sta.*

†Margaret H. Nelson, *Asst. to the Editor.*

†G. A. Osborn, A. M., *Libr.*

†Elizabeth G. Skillman, B. S., *Asst. Libr.*

†C. R. Woodward, M. A., *Editor.*

NEW MEXICO.

New Mexico College of Agriculture and Mechanic Arts and the Agricultural Experiment Station,
State College (freight and express address, Mesilla Park).

*College faculty. †Station staff. ‡Extension staff.

*H. L. Kent, M. S., *President and Dean School of Agr.*

*††Fabian Garcia, M. S., *Dir. of Sta.*

‡C. F. Monroe, M. Agr., *Dir. of Ext. Service.*

R. W. Goddard, B. S., *Dean School of Engin.*

Agronomy: *†J. C. Overpeck, M. S., *Prof. Agron.;*
Agron.

*†W. T. Conway, B. S., *Asst. Prof. and Asst.*
Agron.

———, *Asst. Prof. and Asst. Agron.*

‡G. R. Quesenberry, B. S., *Ext. Agron.*

Animal Industry: *†J. L. Lantow, B. S., *Prof.*
An. Husb.; An. Husb.

*†O. C. Cunningham, B. S., *Prof. Dairying;*
Dairyman.

*†A. L. Walker, M. S., *Prof. Poultry Husb.;*
Poultryman.

‡Hugh Hurst, D. V. M., *Livestock Specialist.*

†P. E. Neale, B. S., *Asst. An. Husb.*

*†M. G. Snell, A. M., *Asst. Prof. and Asst. An.*
Husb.

Biology: *†R. L. Middlebrook, A. B., M. D.,
Head of Dept.

*†R. F. Crawford, M. S., *Asst. Prof. and Asst.*
Biol.

Chemistry: *†C. W. Botkin, A. M., *Prof. Chem.;*
Chem. (State Chem.).

*†G. R. Hamiel, M. A., *Asst. Prof. and Asst.*
Chem.

*†H. W. Titus, A. B., *Asst. Prof. Chem.; Nutr.*
Chem.

†H. L. Wilkins, B. S., *Asst. Chem.*

Education (Agr.): ———, *Prof. Voc. Ed.*

Engineering (Agr.): *E. C. White, B. S., C. E.,
Prof. Irrig. Engin.

†D. W. Bloodgood, B. S. M. E., *Irrig. Engin.*
(*Coop. U. S. D. A.*).

†A. S. Curry, B. S., *Asst. in Irrig.*

Extension (Admin.): †Director Monroe in charge.

†W. L. Elser, B. S., *Asst. Dir.*

†L. H. Hauter, M. S., *Asst. Dir.*

†H. S. Moles, B. S., *Asst. Dir. (County Agt.*
Work).

†Amelia S. Alexander, *State Home Dem. and*
Club Leader.

†C. A. McNabb, *Field Agt. in Marketing.*

Home Economics: †Callie M. Bliss, M. S., *Prof.*
Home Econ.

†Eleanor Murphy, B. S., *Clothing Specialist.*

*Celestine Roach, B. S., *Asst. Prof. Home*
Econ.

Horticulture: Director Garcia in charge.

*†A. B. Fite, B. S., *Assoc. Prof. and Asst. Hort.*

Miscellaneous:

†Floy E. French, *Libr.*

††C. P. Wilson, M. S., *Editor and Executive Secy.*

Substations:

Tucumcari Field Sta.—D. R. Burnham,
B. S., *Supt. and Asst. in Dry Land Agr.*
(*Coop. U. S. D. A.*).

NEW YORK.

New York State College of Agriculture and the Agricultural Experiment Station at Cornell
University, Ithaca.

*College faculty. †Station staff. ‡Extension staff.

*Livingston Farrand, M. D., LL. D., L. H. D., *President of University.*

*A. R. Mann, B. S. A., A. M., *Dean Coll. of Agr.*

†R. W. Thatcher, M. A., D. Agr., *Dir. of Stations.*

‡M. C. Burritt, M. S. A., *Dir. of Ext.*

*Cornellius Betten, Ph. D., D. Sc. *Dir. of Resident Instruction.*

D. S. Kimball, M. E., *Dean Coll. of Engin.*

Agronomy: *††T. L. Lyon, Ph. D., *Head of*
Dept.

*††R. A. Emerson, D. Sc., *Head Dept. of Plant*
Brdg.

‡J. H. Barron, B. S., *Ext. Prof. Field Crops.*

*J. A. Bizzell, Ph. D., *Prof. Soil Tech.*

*H. O. Buckman, Ph. D., *Prof. Soil Tech.*

*F. P. Bussell, Ph. D., *Asst. Prof. Plant Brdg.*

*H. P. Cooper, Ph. D., *Asst. Prof. Agron.*

†W. T. Craig, *Asst. in Cereal Invest. (Coop.*
U. S. D. A.).

‡L. A. Dalton, B. S., *Ext. Instr. Farm Crops.*

*F. H. Dennis, *Asst. in Plant Brdg. Invest.*

*Ernest Dorsey, B. S., *Instr. Plant Brdg.*

*Leah English, B. S., *Analyst in Agron.*

†W. I. Fisher, *Asst. in Plant Brdg. Invest.*

Agronomy—Continued.

*A. C. Fraser, Ph. D., *Asst. Prof. Plant Brdg.*

*A. W. Gibson, B. S., *Instr. Farm Pract.*

‡M. C. Gillis, M. S., *Ext. Instr. Plant Brdg.*

†A. F. Gustafson, Ph. D., *Ext. Prof. Soil Tech.*

†F. B. Howe, M. S., *Soil Surveyor.*

*R. W. Johnson, B. S., *Asst. in Agron.*

*A. C. King, B. S. A., *Prof. Farm Pract. and*
Farm Superintendence.

*D. F. Kinsman, B. S., *Asst. in Soil Tech.*

*L. C. Kirkland, B. S., *Instr. Farm Pract.*

†E. W. Leland, B. S. A., *Experimentalist in*
Soil Tech.

‡J. R. Livermore, B. S., *Ext. Instr. Plant Brdg.*

*H. H. Love, Ph. D., *Prof. Plant Brdg.*

*C. H. Myers, Ph. D., *Prof. Plant Brdg.*

† For subject-matter workers see the respective division, i. e., agronomy, animal industry, etc.

‡ Given in School of General Science.

Agronomy—Continued.

- *R. G. Wiggans, Ph. D., *Asst. Prof. Plant Brdg.*
 *†B. D. Wilson, Ph. D., *Asst. Prof. Soil Tech.; Agron.*
 *†J. K. Wilson, Ph. D., *Prof. Soil Tech.; Agron.*
 †E. L. Worthen, M. S., *Ext. Prof. Soil Tech.*

Animal Husbandry: *†H. H. Wing, M. S.,
Head of Dept.

- *C. L. Allen, Ph. D., *Instr. An. Husb.*
 *R. W. Blakely, B. S., *Instr. An. Husb.*
 †C. A. Boutelle, *Asst. Ext. Prof. An. Husb.*
 †W. T. Crandall, M. S., *Asst. Ext. Prof. An. Husb.*
 †W. T. Grams, B. S., *Ext. Instr. An. Husb.*
 *†M. W. Harper, M. S., *Prof. An. Husb.; An. Husb.*
 *R. B. Hinman, M. S., *Asst. Prof. An. Husb.*
 †H. A. Hopper, M. S., *Ext. Prof. An. Husb.*
 *W. E. Krauss, B. S., *Instr. An. Husb.*
 *†L. A. Maynard, Ph. D., *Prof. An. Husb.; An. Husb.*
 †H. J. Metzger, D. V. M., *Asst. Ext. Prof. An. Husb.*
 *F. H. Peabody, *Stockman in An. Husb.*
 *†E. S. Savage, Ph. D., *Prof. An. Husb.; An. Husb.*

- *C. D. Schutt, *Asst. in An. Husb.*
 †G. W. Tailby, jr., B. S., *Ext. Instr. An. Husb.*
 *E. E. Vial, B. S., *Instr. An. Husb.*

Botany: *†K. M. Wiegand, Ph. D., *Head of Dept.*

- *†O. F. Curtis, Ph. D., *Prof. Bot.; Bot.*
 *A. J. Eames, Ph. D., *Prof. Bot.*
 *Evelyn I. Fernald, M. A., *Instr. Bot.*
 *Mrs. Adele L. Grant, M. A., *Instr. Bot.*
 *Mrs. Julia M. Haber, M. A., *Asst. Bot.*
 *Lewis Knudson, Ph. D., *Prof. Bot.*
 *W. E. Manning, A. B., *Asst. in Bot.*
 *W. C. Muenschner, Ph. D., *Asst. Prof. Econ. Bot.*
 *R. S. Nanz, Ph. D., *Instr. Bot.*
 *L. C. Petry, Ph. D., *Actg. Asst. Prof. Bot.*
 *†Donald Reddick, Ph. D., *Prof. Bot.; Plant Path.*
 *†J. R. Schramm, Ph. D., *Prof. Bot.; Bot.*
 *†L. W. Sharp, Ph. D., *Prof. Bot.; Bot.*
 *C. L. Wilson, M. A., *Instr. Bot.*

Chemistry (Agr.): *††G. W. Cavanaugh, B. S.,
*Prof. Chem. in its Relation to Agr.***Dairy Industry:** *††J. M. Sherman, Ph. D.,
Head of Dept.

- †W. A. Stocking, M. S. A., *Dairy Indus. Research.*
 *H. B. Alger, B. S., *Instr. Dairy Indus.*
 †W. E. Ayres, *Ext. Instr. Dairy Indus.*
 *R. W. Bell, M. S., *Instr. Dairy Indus.*
 †J. D. Brew, M. S., *Ext. Prof. Dairy Indus.*
 *H. R. Currin, B. S., *Instr. Dairy Indus.*
 *†W. W. Fisk, M. S., *Prof. Dairy Indus.; Dairy Indus.*
 *†E. S. Guthrie, Ph. D., *Prof. Dairy Indus.; Dairy Indus.*
 *H. C. Jackson, Ph. D., *Asst. Prof. Dairy Indus.*
 *†T. J. McInerney, M. S., *Asst. Prof. Dairy Indus.; Dairy Indus.*
 *M. P. Moon, Ph. D., *Instr. Dairy Indus.*

Dairy Industry—Continued.

- *E. E. Pittman, Ph. D., *Instr. Dairy Indus.*
 *W. V. Price, M. S., *Instr. Dairy Indus.*
 *†H. E. Ross, M. S., *Prof. Dairy Indus.; Dairy Indus.*
 *†H. C. Troy, B. S., *Prof. Dairy Indus.; Dairy Indus.*

*Randall Whitaker, B. S., *Asst. in Dairy Indus.***Economies (Agr.):** *††G. F. Warren, Ph. D.,
Head of Dept. Prof. Econ. and Farm Mgt.

- *B. W. Barkas, M. A., *Instr. Rural Econ.*
 *J. F. Booth, B. S., *Instr. Marketing.*
 †J. E. Boyle, Ph. D., *Ext. Prof. Rural Econ.*
 †I. F. Hall, B. S., *Ext. Instr. Agr. Econ. and Farm Mgt.*

*†V. B. Hart, Ph. D., *Asst. Ext. Prof. Farm Mgt.**†E. G. Misner, Ph. D., *Prof. Farm Mgt.; Farm Mgt.*†C. E. Ladd, Ph. D., *Ext. Prof. Farm Mgt.**†G. N. Lauman, B. S., *1 ref. Rural Econ.; Rural Econ.**†W. I. Myers, Ph. D., *Prof. Farm Finance; Farm Mgt. Work.**†C. V. Noble, Ph. D., *Asst. Prof. Farm Mgt.; Farm Mgt. Work.**F. A. Pearson, Ph. D., *Prof. Agr. Econ.**E. A. Perregaux, B. S., *Instr. Marketing.**†M. P. Rasmussen, B. S., *Ext. Instr. Farm Mgt.**H. A. Ross, M. S., *Instr. Farm Mgt.**G. P. Scoville, B. S., *Prof. Farm Mgt.**Leland Spencer, Ph. D., *Instr. Farm Mgt. (Coop. U. S. D. A.).**M. F. Thurston, A. B., *Instr. Rural Econ.***Education (Rural):** *††G. A. Works, M. S.,
*Ph. B., Head Dept. Rural Ed.**†E. D. Sanderson, Ph. D., *Head Dept. of Rural Social Organ.**Florence E. Axtell, B. S., *Instr. Rural Ed.**Cora E. Binzel, *Prof. Rural Ed.**J. E. Butterworth, Ph. D., *Prof. Rural Ed.**J. A. Dickey, M. A., *Instr. Rural Social Organ.**T. H. Eaton, Ph. D., *Prof. Rural Ed.**R. A. Felton, M. A., Ph. B., *Prof. Rural Social Organ.**E. N. Ferriss, Ph. D., *Asst. Prof. Rural Ed.**E. R. Hoskins, B. S., *Instr. Rural Ed.**P. J. Kruse, Ph. D., *Prof. Rural Ed.**E. L. Palmer, Ph. D., *Prof. Rural Ed.**R. M. Stewart, Ph. D., *Prof. Rural Ed.*†Mrs. E. E. Strickland, *Ext. Instr. Rural Social Organ.***Engineering (Rural):** *††H. W. Riley, M. E.,
Head of Dept.†F. G. Behrends, B. S., *Ext. Prof. Rural Engin.**F. L. Fairbanks, M. E., *Asst. Prof. Rural Engin.*†A. M. Goodman, B. S., *Asst. Ext. Prof. Rural Engin.**B. A. Jennings, B. S., *Instr. Rural Engin.**J. C. McCurdy, B. S., C. E., *Asst. Prof. Rural Engin.**F. R. Randolph, B. A., M. E., *Asst. Prof. Institutional Engin.**J. E. Reyna, E. E., *Asst. Prof. Rural Engin.**†B. B. Robb, M. S., *Prof. Rural Engin.*

Engineering (Rural)—Continued.

- *L. M. Roehl, B. S., *Asst. Prof. Farm Shop.*
 †N. D. Steve, B. S., *Ext. Prof. Rural Engin.*
 *F. B. Wright, B. S., *Instr. Rural Engin.*

Entomology: *†J. G. Needham, Ph. D., *Litt. D., Head of Dept. Prof. Ent. and Limnology.*

- *†J. C. Bradley, Ph. D., *Prof. Ent.; Curator Invertebrate Zool.*
 *†P. W. Claassen, Ph. D., *Asst. Prof. Biol.*
 *R. B. Cowles, A. B., *Instr. Biol.*
 †C. R. Crosby, A. B., *Ext. Prof. Ent.*
 *†G. C. Embody, Ph. D., *Prof. Aquiculture; Aquiculturist.*

- *W. T. M. Forbes, Ph. D., *Instr. Ent.*
 *H. G. Good, M. S., *Asst. in Ent.*
 *Grace H. Griswold, B. S., *Instr. Ent.*
 †V. R. Haber, M. A., *Ext. Instr. Ent.*
 *†G. W. Herrick, B. S., *Prof. Econ. Ent.; Ent.*
 *†O. A. Johannsen, Ph. D., *Prof. Ent.; Ent.*
 *Elizabeth Keep, B. S., *Asst. in Biol.*
 *†Robert Matheson, Ph. D., *Asst. Prof. Econ. Ent.; Asst. Ent.*

- *C. K. Sibley, B. S., *Instr. Limnology.*
 *L. P. Wehrle, M. S., *Research Instr. Ent.*
 *L. S. West, B. S., *Instr. Parasitol.*
 †R. B. Willson, B. S., *Ext. Instr. Apiculture.*

Extension (Admin.):¹ Director Burritt in charge.

- †Jay Coryell, B. S., *County Agt. Leader.*
 †Martha Van Rensselaer, A. B., *State Home Dem. Leader.*
 †W. J. Wright, M. S., *State Leader Junior Ext., Ext. Prof. Rural Ed.*
 †Adelaide A. Barts, B. S., *Asst. State Home Dem. Leader.*
 †Erl Bates, M. D., *Adviser in Indian Ext.*
 †Helen Canon, B. S., *Assoc. State Leader Home Dem. Agts., Asst. Ext. Prof. Home Econ.*
 *†D. J. Crosby, M. S., *Prof. in Ext. Service.*
 †P. L. Dunn, B. S., *Instr. in Ext. Service.*
 *†G. A. Everett, A. B., LL. B., *Prof. Ext. Teaching.*
 †E. A. Flansburgh, B. S., *Asst. County Agt. Leader.*
 †Claribel Nye, B. S., *Assoc. State Home Dem. Leader, Asst. Ext. Prof. Home Econ.*
 *†G. E. Peabody, B. S., *Instr. in Ext. Service.*
 *†Montgomery Robinson, Litt. B., B. S., *Prof. in Ext. Service.*
 †L. R. Simons, B. S., *Asst. County Agt. Leader.*
 †Mrs. Ruby G. Smith, Ph. D., *Assoc. State Leader Home Dem. Agts.*
 †C. A. Taylor, *Asst. County Agt. Leader.*
 *†R. H. Wheeler, B. S., *Prof. in Ext. Service.*
 †D. P. Witter, *Adviser in Institute Ext.*
 †P. R. Young, B. S., *Asst. State Leader Junior Ext.*

Forestry: *†R. S. Hosmer, B. A. S., M. F., *Head of Dept.*

- *†John Bentley, jr., M. F., *Prof. For. Engin.; For.*
 †F. E. Cobb, B. S., *Instr. Ext. For.*
 *C. H. Guise, M. F., *Asst. Prof. For. Mgt.*
 *A. B. Recknagel, M. F., *Prof. For. Mgt. and Utilization.*
 *S. N. Spring, M. F., *Prof. Silviculture.*

Home Economies: *†Martha Van Rensselaer, A. B., *Head of Dept.*

- *†Flora Rose, M. A., *Head of Dept.*
 *Beulah Blackmore, B. S., *Asst. Prof. Home Econ.*
 †Alice M. Blinn, B. S., *Ext. Instr. Home Econ.*
 *Mrs. Jessie A. Boys, M. S., *Asst. Prof. Home Econ.*
 †Sarah L. Brewer, B. S., *Asst. Ext. Prof. Home Econ.*
 *Frances A. Brookins, *Instr. Home Econ.*
 †Bertine Collins, B. S., *Ext. Instr. Nutr.*
 *Irene T. Dahlberg, B. S., *Instr. Home Econ.*
 †Ola Day, Ph. B., *Ext. Instr. Home Econ.*
 *Lois A. Farmer, B. S., *Instr. Home Econ. and Mgr. of Cafeteria.*
 *Faith Fenton, B. S., *Instr. Home Econ.*
 †Mildred N. Gardner, B. S., *Ext. Instr. Home Econ.*
 *Mrs. Lolita Georgia, A. B., *Instr. Home Econ. and Accounting.*
 †Edna G. Gleason, B. S., *Ext. Instr. Home Econ.*
 *Mary F. Henry, A. B., *Asst. Prof. Home Econ.*
 †Erma E. Hollen, M. S., *Ext. Instr. Home Econ.*
 *Frances B. Hunter, B. S., *Asst. Prof. Home Econ.*
 †Jennie C. Jones, *Ext. Instr. Home Econ.*
 *Ruth M. Kellogg, B. S., *Asst. Prof. Home Econ.*
 *Helen L. McGregor, A. M., *Instr. Home Econ.*
 *Mrs. Carolyn B. McIlroy, *Instr. Home Econ.*
 †Nancy H. McNeal, Ph. B., *Asst. Ext. Prof. Home Econ.*
 *H. B. Meek, M. A., *Asst. Prof. Institutional Mgt.*
 *Helen Monsch, M. A., *Prof. Home Econ.*
 *†Caroline Morton, B. S., *Instr. Home Econ. Ext.*
 *Winifred Moses, B. S., *Asst. Prof. Home Econ.*
 *†Ellen A. Reynolds, M. S., *Asst. Prof. Home Econ.*
 *Reena Roberts, M. A., *Instr. Home Econ.*
 †Doris Schumaker, B. S., *Asst. Prof. Home Econ.*
 †Ruth J. Scott, B. S., *Ext. Instr. Home Econ.*
 *Adelaide Spohn, Ph. D., *Asst. Prof. Home Econ.*
 *Beulah E. Stannard, B. S., *Instr. Home Econ.*
 †Flora M. Thurston, B. S., *Asst. Ext. Prof. Home Econ.*
 *Annette J. Warner, *Prof. Home Econ.*
 †Ann M. Watkins, *Ext. Instr. Home Econ.*
 *Dora H. Wetherbee, *Asst. Prof. Home Econ.*

Horticulture: *†E. A. White, B. S., *Head Dept. of Flor. and Ornamental Hort.*

- *†H. C. Thompson, M. S., *Head Dept. of Veg. Gard.*
 *†A. J. Heinicke, Ph. D., *Head Dept. of Pomol.*
 †R. M. Adams, B. S., *Asst. Ext. Prof. Veg. Gard.*
 *†A. C. Beal, Ph. D., *Prof. Flor.; Flor.*
 *†D. B. Carrick, Ph. D., *Prof. Pomol.; Research Pomol.*
 *†R. W. Curtis, M. S., *Prof. Ornamental Hort.*
 *E. G. Davis, B. S., *Prof. Landsc. Arch.*
 *†E. V. Hardenburg, Ph. D., *Asst. Prof. Veg. Gard., Veg. Gard.*

¹ For subject-matter workers see the respective division, i. e., agronomy, animal husbandry, etc.

Horticulture—Continued.

- *F. S. Howlett, B. S., *Instr. Pomol.*
 *C. E. Hunn, *Instr. Ornamental Hort.*
 †W. E. Loomis, M. S., *Asst. in Veg. Gard.*
 *L. H. MacDaniels, Ph. D., *Prof. Pomol.*
 *H. S. Mills, M. S., *Instr. Veg. Gard.*
 *Lua A. Minns, M. S., *Instr. Flor.*
 *A. H. Nehrling, *Asst. Prof. Flor.*
 †Joseph Oskamp, B. S., *Ext. Prof. Pomol.*
 †G. W. Peck, M. S., *Ext. Prof. Pomol.*
 †J. P. Porter, M. S., M. L. D., *Asst. Ext. Prof. Ornamental Hort.*
 *A. W. W. Sand, M. S., *Supt. Flor. Invest.*
 *H. W. Schneek, M. S., *Asst. Prof. Veg. Gard.*
 †F. O. Underwood, B. S., *Asst. Ext. Prof. Veg. Gard.*
 *†P. H. Wessels, M. S., *Research Prof. Veg. Gard. (P. O., Riverhead).*
 *†Paul Work, Ph. D., *Prof. Veg. Gard.; Veg. Gard.*

Meteorology: *†W. M. Wilson, M. D., *Head of Dept.*

*R. A. Mordoff, Ph. D., *Asst. Prof. Met.*

Plant Pathology: *†L. M. Massey, Ph. D., *Head of Dept.*

- †M. F. Barrus, Ph. D., *Ext. Prof. Plant Path.*
 *†F. M. Blodgett, Ph. D., *Asst. Prof. Plant Path.; Plant Path.*
 *W. H. Burkholder, Ph. D., *Asst. Prof. Plant Path.*
 †C. D. Chupp, Ph. D., *Asst. Ext. Prof. Plant Path.*
 *L. M. Fenner, B. S., *Instr. Plant Path.*
 *†H. M. Fitzpatrick, Ph. D., *Prof. Plant Path.; Plant Path.*
 †E. F. Guba, Ph. D., *Asst. Ext. Prof. Plant Path.*
 *E. E. Honey, B. S., *Instr. Plant Path.*
 *S. E. A. McCallan, B. S., *Asst. in Plant Path.*
 *D. S. Welch, B. S., *Instr. Plant Path.*

Plant Pathology—Continued.

- *Cynthia Wescott, A. B., *Instr. Plant Path.*
 *†H. H. Whetzel, M. A., *Prof. Plant Path.; Plant Path.*

Poultry Husbandry: *†J. E. Rice, B. S., *Head of Dept.*

- †L. E. Botsford, B. S., *Asst. Ext. Prof. Poultry Husb.*
 *R. C. Bradley, M. S., *Instr. Poultry Husb.*
 *G. O. Hall, M. S., *Instr. Poultry Husb.*
 *†G. F. Heuser, Ph. D., *Prof. Poultry Husb.; Poultry Husb.*
 †L. M. Hurd, *Ext. Instr. Poultry Husb.*
 †W. G. Krum, *Ext. Instr. Poultry Husb.*
 *C. E. Lee, B. S., *Instr. Poultry Husb.*
 *L. C. Norris, B. S., *Instr. Poultry Husb.*
 †R. C. Ogle, *Ext. Instr. Poultry Husb.*
 *C. K. Powell, M. S., *Instr. Poultry Husb.*
 †John Vandervort, jr., B. S., *Ext. Instr. Poultry Husb.*

†L. E. Weaver, B. S., *Asst. Ext. Prof. Poultry Husb.*

Publication: *†Bristow Adams, B. A., *Editor and Chief of Pubs., Prof. in Ext. Service.*

*†M. V. Atwood, A. B., *Asst. Chief of Pubs. and Prof. in Ext. Service.*

†Lela G. Gross, *Asst. Editor of Pubs.*

*†H. A. Stevenson, B. S., *Asst. Prof. in Ext. Service and Supvr. Farm Study Courses.*

†Katherine Thorp, M. A., *Asst. Editor of Pubs.*

Zoology: *H. D. Reed, Ph. D., *Prof. Zool.*

*†A. A. Allen, Ph. D., *Asst. Prof. Ornith.; Ornith.*

†S. H. Burnham, B. S., *Asst. Curator.*

*Mary J. Fisher, Ph. D., *Instr. Zool.*

*Francis Harper, *Instr. Ornith.*

*Eleanor C. McMullen, A. B., *Instr. Zool.*

*Amy G. Mekeel, A. M., *Instr. Zool.*

*M. D. Pirnie, B. S., *Instr. Ornith.*

*H. E. Thomas, B. S., *Asst. Prof. Zool.*

*A. H. Wright, Ph. D., *Asst. Prof. Zool.*

*B. P. Young, Ph. D., *Asst. Prof. Zool.*

New York State Agricultural Experiment Station, Geneva.

†Station staff.

†R. W. Thatcher, M. A., D. Agr., *Director.*

Agronomy: †R. C. Collison, M. S., *Chief in Research (Agron.).*

†G. W. Churchill, *Agr.*

†J. D. Harlan, B. S., *Asst. in Research (Agron.).*

†J. E. Mensching, M. S., *Assoc. in Research (Agron.).*

Animal Industry: †A. C. Dahlberg, M. S., *Assoc. in Research (Dairying).*

†J. C. Henning, M. S., *Asst. in Research (Dairying).*

†J. C. Marquardt, B. S., *Assoc. in Research (Dairying).*

†W. P. Wheeler, *Assoc. in Research (Poultry).*

Bacteriology: †R. S. Breed, Ph. D., *Chief in Research (Bact.).*

†H. J. Conn, Ph. D., *Chief in Research (Soil Bact.).*

†G. J. Hucker, M. A., *Assoc. in Research (Bact.).*

†A. H. Robertson, B. S., *Asst. in Research (Bact.).*

Biochemistry: †R. J. Anderson, Ph. D., *Chief in Research (Biochem.).*

†F. P. Nabenhauer, Ph. D., *Asst. in Research (Biochem.).*

Botany: †F. C. Stewart, M. S., *Chief in Research (Bot.).*

†E. E. Clayton, Ph. D., *Assoc. in Research (Plant Path.; P. O., Riverhead, L. I.).*

†W. O. Gloyer, M. A., *Assoc. in Research (Bot.).*

†Elizabeth F. Hopkins, A. B., *Asst. in Research (Bot.).*

†M. T. Munn, M. S., *Assoc. in Research (Bot.).*

†W. H. Rankin, Ph. D., *Assoc. in Research (Plant Path.).*

†E. V. Shear, jr., M. S., *Assoc. in Research (Plant Path.).*

Chemistry: †L. L. Van Slyke, Ph. D., *Chief in Research (Chem.).*

†D. C. Carpenter, Ph. D., *Assoc. in Research (Chem.).*

Chemistry—Continued.

- †A. W. Clark, B. S., *Assoc. in Research (Chem.)*.
 †M. G. Moore, B. S., *Asst. in Research (Chem.)*.
 †W. F. Morton, B. S., *Asst. in Research (Chem.)*.
 †L. R. Streeter, M. S., *Asst. in Research (Insecticide and Fungicide Invest.)*.
 †M. P. Sweeney, M. A., *Asst. in Research (Chem.)*.
 †W. F. Walsh, B. S., *Asst. in Research (Chem.)*.

Entomology: †P. J. Parrott, M. A., *Chief in Research (Ent.)*.

- †Hugh Glasgow, Ph. D., *Assoc. in Research (Ent.)*.
 †S. W. Harman, B. S., *Asst. in Research (Ent.)*.
 †F. Z. Hartsell, M. A., *Assoc. in Research (Ent., Chautauqua Grape Work: P. O., Fredonia)*.
 †H. C. Hockett, Ph. D., *Assoc. in Research (Ent.: P. O., Riverhead, L. I.)*.
 †F. H. Lathrop, Ph. D., *Assoc. in Research (Ent.)*.

Entomology—Continued.

- †G. F. MacLeod, B. S., *Asst. in Research (Ent.)*.
Horticulture: †U. P. Hedrick, D. Sc., *Chief in Research (Hort.), Vice Dir. of Sta.*
 †Alwin Berger, *Asst. in Research (Hort.)*.
 †Olav Einset, B. A., *Asst. in Research (Hort.)*.
 †F. E. Gladwin, B. S., *Assoc. in Research (Hort., Chautauqua Grape Work. P. O., Fredonia)*.
 †F. H. Hall, B. S., *Assoc. in Research (Veg. Gard. and Canning Crops)*.
 †G. H. Howe, B. S., *Assoc. in Research (Hort.)*.
 †G. L. Slate, B. S., *Asst. in Research (Hort.)*.
 †O. M. Taylor, *Assoc. in Research (Hort.)*.
 †H. B. Tukey, M. S., *Assoc. in Research (Hort.)*.
 †Richard Wellington, M. S., *Assoc. in Research (Hort.)*.

Miscellaneous:

- †J. D. Luckett, M. S., *Editor*.
 †Catherine S. Oaks, B. A., *Libr.*

NORTH CAROLINA.**North Carolina State College of Agriculture and Engineering and the Agricultural Experiment Station, State College Station, Raleigh.**

*College faculty. †Station staff. ‡Extension staff.

*E. C. Brooks, A. B., *President*.

*†B. W. Kilgore, M. S., Sc. D., *Dean School of Agr., Dir. of Sta., Dir. of Ext. Service*.

*W. C. Riddick, C. E., LL. D., *Dean of Engin.*

Agronomy: *†C. B. Williams, M. S., *Head of Div. Vice Dir. of Sta.*

††R. Y. Winters, Ph. D., *Plant Breeder and Assoc. Chief of Div.*

‡E. C. Blair, B. S., *Asst. Agron.*

*J. B. Cotner, B. Pd., *Asst. Prof. Farm Crops*.

*W. H. Darst, B. S., *Prof. Farm Crops*.

†S. F. Davidson, B. S., *Asst. in Soil Survey*.

†W. A. Davis, *Asst. in Soil Survey*.

*R. B. Etheridge, B. S., *Instr. Soils*.

††G. M. Garren, Ph. B., *Asst. Agron. in Plant Brdg.*

†R. J. Harris, *Asst. in Field Expts.*

††S. W. Hill, B. S., *Asst. in Plant Brdg.*

†S. K. Jackson, B. S., *Asst. Agron. (Soils)*.

†P. H. Kime, B. S., *Agron. Specialist (Coop. U. S. D. A.)*.

††W. F. Pate, M. S., *Agron. (Soils)*.

†L. G. Willis, B. S., *Soil Chem.*

Animal Industry: *R. H. Ruffner, B. S., *Prof. An. Husb. and Dairying*.

*†B. F. Kaupp, M. S., D. V. S., *Prof. Poultry Sci., Poultry Invest. and Path.*

†J. A. Arey, B. S., *Dairy Farming (Coop. U. S. D. A.)*.

*W. F. Armstrong, B. S., *Instr. Poultry Husb.*

††W. L. Clevenger, B. S., *Dairy Mfg. Specialist*.

††R. S. Curtis, B. S., *Assoc. in An. Indus.*

†R. S. Dearstyne, M. S., *Assoc. in Poultry Invest. and Path.*

††F. R. Farnham, *Asst. in Dairy Farming (Coop. U. S. D. A.)*.

*F. M. Haig, M. S., *Asst. Prof. An. Husb. and Dairying*.

††W. V. Hays, *Swine Specialist*.

Animal Industry—Continued.

†Earl Hostetler, B. S., *Asst. in Beef Cattle and Swine Invest.*

‡A. C. Kimrey, A. B., *Asst. in Dairy Farming*.

‡A. G. Oliver, *Poultry Ext. (Coop. U. S. D. A.)*.

†W. W. Shay, *Swine Husb. Ext. (Coop. U. S. D. A.)*.

†E. G. Wardin, *Asst. in Poultry Invest. and Path.*

‡G. P. Williams, M. A., *Sheep Husb. Ext.*

†V. M. Williams, M. S., *Dairy Experimentalist*.

Botany: *B. W. Wells, Ph. D., *Prof. Bot.*

†F. A. Wolf, Ph. D., *Plant Path.*

‡G. W. Fant, M. S., *Ext. Plant Path.*

†S. G. Lehman, Ph. D., *Asst. Plant Path.*

*A. C. Martin, A. B., *Instr. Bot.*

*I. V. D. Shunk, A. M., *Asst. Prof. Bot.*

Chemistry: *W. A. Withers, Sc. D., *Prof. Chem., Vice Pres. of Coll.*

†W. G. Haywood, B. Litt., *Fert. Chem.*

†J. O. Halverson, Ph. D., *Nutr. Invest.*

†Z. B. Bradford, B. S., *Asst. Chem.*

†E. S. Dewar, B. S., *Asst. Chem.*

*W. E. Jordan, M. A., *Asst. Prof. Chem.*

*C. F. Miller, B. S., *Instr. Chem.*

†R. L. Mills, B. S., *Asst. Chem.*

†L. M. Nixon, B. S., *Asst. Chem. in Nutr. Invest.*

*T. B. Parks, A. B., *Instr. Chem.*

*E. E. Randolph, Ph. D., *Assoc. Prof. Chem.*

†F. W. Sherwood, Ph. D., *Asst. Chem. in Nutr. Invest.*

*H. G. Smith, B. S., *Instr. Chem.*

*M. F. Trice, B. S., *Instr. Chem.*

†C. L. Williams, B. S., *Asst. Chem.*

*L. F. Williams, Ph. D., *Prof. Anal. Chem.*

Economics (Rural): *B. F. Brown, B. S., *Dean of School.*

†G. R. Ross, B. S., *Chief Div. of Markets.*

*C. C. Taylor, Ph. D., *Prof. Rural Organ., Dean of Grad. School.*

*W. A. Anderson, M. S., *Instr. Agr. Econ. and Rural Sociol.*

*G. W. Forster, Ph. D., *Prof. Agr. Econ.*

†P. H. Hart, *Asst. in Cotton Grading and Marketing (Coop. U. S. D. A.).*

†V. W. Lewis, *Livestock Marketing.*

*R. O. Moen, M. A., *Assoc. Prof. Rural Econ.*

*R. J. Saville, B. S., *Instr. Farm Mgt.*

†Gorrell Shumaker, B. S., *Asst. in Marketing Fruits and Veggies.*

Education (Agr.): *L. E. Cook, M. S., *Prof. Voc. Ed.*

*L. O. Armstrong, B. S., *Instr. Voc. Ed.*

*W. L. Mayer, B. S., *Assoc. Prof. Voc. Ed.*

Engineering (Agr.): Dean Riddick in charge.

††F. O. Bartel, C. E., *Drainage Engin. (Coop. U. S. D. A.).*

*C. R. Bohanan, B. S., *Instr. Agr. Engin.*

*R. E. Bosque, B. S., *Prof. Agr. Engin.*

†E. R. Raney, B. S., *Farm Engin. Specialist.*

D. S. Weaver, B. S., *Assoc. Prof. Agr. Engin.*

Extension (Admin.): † Director Kilgore in charge.

†J. M. Gray, B. S., *Asst. Dir.*

†C. R. Hudson, M. S., *in charge Negro Work.*

†Mrs. Jane S. McKimmon, *State Home Dem. Agt.*

†S. J. Kirby, B. S., *Asst. State Club Agt.*

†Maude E. Wallace, *Asst. State Home Dem. Agt.*

Horticulture: *†J. P. Pillsbury, B. S., *Prof. Hort.; Hort.*

†C. D. Matthews, B. S., *Chief Hort. (State Hort.).*

†H. R. Niswonger, M. A., *Ext. Hort.*

†R. F. Payne, B. S., *Asst. Hort.*

Horticulture—Continued.

†W. A. Radspinner, M. S., *Research Pomol.*

†Robert Schmidt, B. S., *Asst. State Hort.*

*†J. W. Trotter, B. S., *Instr. Hort.*

†C. F. Williams, B. S., *Asst. Hort.*

Physics: *J. B. Derieux, Ph. D., *Prof. Phys.*

*A. A. Dixon, A. M., *Asst. Prof. Phys.*

*C. M. Heck, M. A., *Prof. Phys.*

Veterinary Science: *W. C. Reeder, M. S., V. M. D., *Prof. Vet. Sci. and Physiol.*

†F. D. Owen, D. V. M., *Hog Cholera Work (Coop. U. S. D. A.).*

Zoology and Entomology: *†Z. P. Metcalf, B. A., *Prof. Zool. and Ent.; Ent.*

††Franklin Sherman, jr., M. S., *Chief Ent.*

†J. C. Crawford, *Ext. Ent.*

*J. E. Eckert, M. S., *Asst. Prof. Zool. and Ent.*

†J. A. Harris, *Ext. Ent.*

††R. W. Leiby, Ph. D., *Asst. Ent.*

†W. B. Mabee, B. S., *Ext. Ent.*

†C. L. Sams, *Beekeeping (Coop. U. S. D. A.).*

Miscellaneous:

†F. H. Jeter, B. S., *Agr. Editor.*

*Mrs. Charlotte M. Williamson, *Libr.*

Substations: F. E. Miller, B. S., *in charge.*

Black Land Branch Sta., P. O., *Wenona—J. L. Res, jr., Asst. Dir.*

Coastal Plain Branch Sta., P. O., *Willard—Charles Dearing, B. S., Asst. Dir. (Coop. U. S. D. A.).*

Edgecombe Branch Sta., P. O., *Rocky Mount—R. E. Currin, jr., Asst. Dir.*

Mountain Branch Sta., P. O., *Swannanoa—S. C. Clapp, Asst. Dir.*

Piedmont Branch Sta., P. O., *Statesville—F. T. Meacham, M. S., Asst. Dir.*

Tobacco Branch Sta., P. O., *Oxford—E. G. Moss, Asst. Dir. (Coop. U. S. D. A.).*

The Negro Agricultural and Technical College, Greensboro.

*Agricultural faculty. †Extension staff.

*J. B. Dudley, A. M., LL. D., *President.*

*B. F. Bullock, B. S., *Dir. Dept. of Agr., Prof. Rural Ed.*

*E. F. Colson, B. S., *Supt. and Instr. Dairying.*

*L. E. Davis, B. S., *Supt. and Instr. Poultry Husb.*

*O. G. Donnell, *Instr. Hort. and Greenhouse Mgt., Florist.*

*J. A. McRae, B. S., *Farm Mgt., Farm Supt.*

*J. H. Nicholas, B. Ch., *Instr. Chem. and Phys.*

*C. S. Parker, M. S., *Prof. Hort. and Bot.*

*A. A. Turner, B. S., *Co-Dir. Dept. of Agr., Prof. Crops.*

†J. D. Wray, M. S., *State Agt. Boys' and Girls' Clubs.*

NORTH DAKOTA.

North Dakota Agricultural College and the Agricultural Experiment Station, *Agricultural College (freight and express address, Fargo).*

*College faculty. †Station staff. ‡Extension staff.

*J. L. Coulter, Ph. D., LL. D., *President. (Advisory, Agr. Econ.).*

*C. B. Waldron, B. S., *Dean School of Agr.*

*†P. F. Trowbridge, Ph. D., *Dir. of Sta. Prof. Research Methods.*

*†G. W. Randlett, B. S., *Dir. of Agr. Ext. Prof. Ext. Methods.*

E. S. Keene, M. E., *Dean School of Mech. Arts.*

Agronomy: *†H. L. Walster, Ph. D., *Chair of Dept. Prof. Agron. and Soils; in charge Soil Survey.*

†Erich Cahn, *Asst. in Plant Brdg.*

*†J. E. Chapman, M. S., *Instr. Soils; Soil Survey Work.*

Agronomy—Continued.

*O. O. Churchill, M. S., *Prof. Agron. (Farm Crops).*

†E. I. Olsen, B. S., *Asst. Agron. (Flax Invest.), and Supt. Dem. Farms.*

†Thomas Sanderson, *Miller.*

¹ For subject-matter workers see the respective division, i. e., agronomy, animal industry, etc.

Agronomy—Continued.

- †T. E. Stoa, M. S., *Asst. Agron.*
 †L. R. Waldron, M. A., *Agron. (Plant Brdg.).*
Animal Industry: †J. H. Shepperd, M. S.,
Chair. of Dept.
 *†J. R. Dice, A. M., *Prof. Dairy Husbandry; Dairy Husband.*
 †G. J. Baker, M. S., *State Agt. in Livestock.*
 †O. A. Barton, *Poultryman and State Agt. in Poultry Husband.*
 *†F. W. Christensen, M. S., *Prof. An. Nutr.; An. Nutr.*
 †D. J. Griswold, Jr., A. M., *An. Husband.*
 *†L. R. Holland, B. S., *Instr. and in charge Dairy Mfrs.*
 †Max Morgan, B. S., *State Agt. in Dairying.*
 *A. S. Severson, M. S., *Instr. An. Husband.*
 *E. J. Thompson, B. S., *Prof. An. Husband.*

Botany, Bacteriology, and Zoology: *†H. L.

- Bolley, M. S., *Dean of Biol., Prof. Bot. and Plant Path.; Bot. and Plant Path.*
 †W. E. Brentzel, M. A., *Plant Path. (Coop. U. S. D. A.).*
 †W. G. Couey, B. S., *Seed Insp., State Agt. in Path.*
 *E. T. Drake, M. S., *Instr. Bot. and Bact.*
 *†Mayme Dworak, A. M., *Asst. Prof. Bot. and Bact.; Bot.*
 †H. D. Long, *Seed Analyst.*
 †G. C. Mayoue, B. S., *Ext. Plant Path.*
 *G. E. Miller, M. A., *Prof. Biol.*
 *†C. I. Nelson, A. B., *Prof. Bact.; Bact. and Soil Biol.*
 *E. S. Reynolds, Ph. D., *Prof. Bot.*
 *†O. A. Stevens, M. S., *Asst. Prof. Bot.; Asst. Bot. and Seed Analyst.*
 †Wanda Weniger, Ph. D., *Asst. Bot. and Plant Path.*
 *A. D. Whedon, Ph. D., *Prof. Zool. and Physiol.*
 †R. S. Zimmerman, *Biol. Asst. (Detailed by U. S. D. A.).*

Chemistry: *W. T. Pearce, Ph. D., *Prof. Chem.*

- †T. H. Hopper, M. A., *Agr. Chem.*
 *†J. E. Adams, M. S., *Instr. Chem.*
 *L. L. Carrick, Ph. D., *Assoc. Prof. Gen. Chem.*
 *C. A. Gottschalck, M. S., *Prof. Org. Chem.*
 †C. E. Mangels, A. M., *Cereal Chem.*
 †L. L. Nesbitt, B. S., *Asst. Agr. Chem.*
 *R. E. Remington, A. B., *Assoc. Prof. Physiol. Chem.*

Economics (Agr.): *C. E. Miller, M. S., *Chair. of Dept., Prof. Agr. Econ.*

- *†A. H. Benton, Ph. D., *Marketing and Rural Finance.*
 †R. E. Willard, B. S., *Farm Mgt. and Rural Econ. (State Agt.).*
 †J. A. Barner, *Asst. in Farm Mgt. (Coop. U. S. D. A.).*
 *O. M. Fuller, B. S., *Instr. Agr. Econ.*
 *A. F. Hunsaker, Ph. D., *Prof. Sociol. and Econ. Sci.*
 †H. E. Kjolrie, B. S., *Asst. in Agr. Econ.*
 *Ross McReynolds, M. A., *Instr. Agr. Econ.*
 †T. S. Thorfinnson, M. S., *Asst. in Farm Mgt.*
 †Stanley Wilner, B. S., *Agt. in Farm Mgt. (Coop. U. S. D. A.).*

Editorial and Publicity: *†W. C. Palmer, M. S., *Agr. Editor.***Editorial and Publicity—Continued.**

- †Maynard Brown, B. S., *Asst. Editor.*
 †Sidney Hooper, B. S., *Asst. Editor.*
 †R. A. Corbett, *Photog.*
Education (Agr.): *E. H. Jones, M. A., *Prof. Agr. Ed.*
 *R. E. McConnell, M. S., *Instr. Agr. Ed.*
Engineering (Agr.): *†R. C. Miller, B. S., *Asst. Prof. Agr. Engin.*
Entomology: *†R. L. Webster, Ph. D., *Prof. Ent.; Ent.*
Extension (Admin.): †Director Randlett, *in charge.*
 †J. W. Haw, *County Agt. Leader.*
 †Mrs. Myrtle G. Cole, B. A., *Supvr. of Projects (Women's Work).*
 †H. E. Rilling, M. S., *Supvr. of Projects (Club Work).*
 †Grace DeLong, B. S., *Asst. Supvr. of Projects.*
 †N. D. Gorman, *Asst. Supvr. of Projects.*
 †Pauline M. Reynolds, B. A., *Asst. Supvr. of Projects.*
 †E. A. Willson, B. S., *Asst. Supvr. of Projects.*

Home Economics: *Alba Bales, M. A., *Head of School.*

- *Minnie A. Anderson, M. A., *Asst. Prof. Home Econ.*
 †Eulalia Church, B. S., *State Agt. in Clothing.*
 *Helen C. Finlayson, A. B., *State Supvr. Home Econ.*
 *Constance Leeb, B. S., *Instr. Home Econ.*
 †Mrs. Dorothy A. Loudon, B. S., *State Agt. in Nutr.*
 *Elvira T. Smith, M. A., *Asst. Prof. Home Econ.*
 †Hazel B. Spencer, B. A., *State Agt. in Nutr.*
 *Lucille M. Stanley, B. S., *Instr. Dom. Art.*
 †Ruth K. Willard, A. B., *State Agt. in Home Mgt.*

Horticulture: Dean Waldron, *Chair. of Dept., Prof. Hort. and For.*

- *†A. F. Yeager, M. S., *Asst. Prof. Hort.; Hort.*

Veterinary Science: *†A. F. Schalk, D. V. M., *Head of School, Prof. Vet. Sci.; Vet.*

- *†R. S. Amadon, D. V. M., *Asst. Prof. Physiol., Pharmacol.; Asst. Vet.*
 *†H. L. Foust, D. V. M., *Asst. Prof. Vet. Sci.; Asst. Vet.*
 †Don McMahon, M. D. C., *State Agt. in An. Health.*
 *†L. M. Roderick, D. V. M., M. S., *Asst. Prof. Vet. Sci.; Asst. Vet.*

Miscellaneous:

- *†J. D. Brandmeyer, *Supt. of Coll. Farm.*
 *Mrs. Ethel McVeety, *Libr.*
 *Harriet A. Pearson, A. B., *Asst. Libr.*

Substations:

- Dickinson—
 Leroy Moomaw, B. S., *Supt. (Coop. U. S. D. A.).*
 Ralph Smith, B. S., *Agron. (Coop. U. S. D. A.).*
 Edgeley—O. A. Thompson, B. S., *Supt.*
 Hettinger—U. J. Downey, B. S., *Supt.*
 Langdon—Louis Jorgenson, B. S., *Supt.*
 Williston—A. C. Kuennig, B. S., *Supt.*

¹ For subject-matter workers see the respective division, i. e., agronomy, animal industry, etc.

OHIO.

The Colleges of Agriculture and of Veterinary Medicine and the Departments of Agricultural Education and Home Economics, Ohio State University, Columbus.

*College faculty. †Extension staff.

*W. O. Thompson, A. M., D. D., LL. D., *President of University.**Alfred Vivian, Ph. G., *Dean Coll. of Agr.*†H. C. Ramsower, B. S., *Dir. of Agr. Ext. Work.**D. S. White, D. V. M., *Dean Coll. of Vet. Med.*E. A. Hitchcock, M. E., *Dean Coll. of Engin., Dir. Engin. Expt. Sta.***Animal Industry:** *C. W. Gay, B. S., D.V. M.,
*Head Dept. of An. Husb.**Oscar Erf, B. S., *Head Dept. of Dairy Husb.**E. L. Dakan, B. S., *Head Dept. of Poultry Husb.**J. S. Coffey, B. S., *Prof. An. Husb.**C. T. Conklin, B. S., *Asst. Prof. An. Husb.*†R. E. Cray, B. S., *Poultry Specialist.**H. D. Drain, B. S., *Asst. Prof. Dairying.*†Paul Gerlaugh, B. S., *An. Husb. Specialist.**D. J. Kays, B. S., *Prof. An. Husb.**D. S. Kochheiser, B. S., *Instr. Dairying.*†Ivan McKellip, M. S., *Cow Testing Work (Coop. U. S. D. A.).**C. S. Plumb, B. S., *Prof. An. Husb.**R. E. Roberts, B. S., *Instr. Poultry Husb.*†S. M. Salisbury, B. S., *An. Husb. Specialist.**R. B. Stoltz, B. S., *Prof. Dairying.*†G. S. Vickers, B. S., *Poultry Husb. Specialist.*†J. W. Wuichet, B. S., *An. Husb. Specialist.***Botany:** *E. N. Transeau, Ph. D., *Head of Dep't., Prof. Plant Physiol.**R. A. Dobbins, M. S., *Instr. Bot.**Lois Lampe, M. S., *Instr. Bot.**B. S. Meyer, M. A., *Instr. Bot.**D. M. Moore, M. S., *Instr. Bot.**H. C. Sampson, Ph. D., *Prof. Bot.**J. D. Sayre, Ph. D., *Instr. Bot.**J. H. Schaffner, Ph. D., *Prof. Bot.**W. G. Stover, Ph. D., *Prof. Bot.**L. H. Tiffany, Ph. D., *Instr. Bot.**A. E. Waller, Ph. D., *Asst. Prof. Bot.***Chemistry (Agr.):** *J. F. Lyman, Ph. D., *Head of Dept.**E. F. Almy, M. A., *Instr. Agr. Chem.**R. C. Burrell, M. A., *Instr. Agr. Chem.**C. P. Hinkle, M. A., *Asst. in Agr. Chem.**T. G. Phillips, Ph. D., *Prof. Agr. Chem.**T. G. Watson, M. S., *Asst. Prof. Agr. Chem.***Economics (Rural):** *J. I. Falconer, Ph. D.,
Head of Dept.†C. R. Arnold, B. S., *Asst. Farm Mgt. Dem.**C. E. Lively, M. A., *Asst. Prof. Rural Sociol.**C. G. McBride, M. S., *Asst. Prof. Marketing.**F. L. Morison, M. S., *Instr. Rural Econ.*†R. F. Taber, B. S., *Farm Mgt. Dem.*†E. J. Utz, *Asst. Farm Mgt. Dem.*†B. A. Wallace, M. A., *Marketing Specialist.***Education (Agr.):** *W. F. Stewart, M. S., *Head of Dept.**F. O. Bolender, B. S., *Instr. Agr. Ed. (P. O., Hilliard).**W. F. Bruce, B. S., *Instr. Agr. Ed. (P. O., Lockbourne).***Education (Agr.)—Continued.***C. F. Christian, B. S., *Instr. Agr. Ed. (P. O., Canal Winchester).*†H. E. Eswine, *Instr. Agr. Ed.**Harold Kenestrick, B. S., *Asst. Prof. Agr. Ed.**A. C. Kennedy, B. S., *Instr. Agr. Ed. (P. O., Worthington).**J. B. McClelland, B. S., *Instr. Agr. Ed. (P. O., Grove City).**H. W. Nisonger, B. S., *Asst. Prof. Agr. Ed.***Engineering (Agr.):** *F. W. Ives, B. S., M. E.,
*Head of Dept.**G. W. McCuen, B. S., *Prof. Agr. Engin.*†W. P. Miller, B. S., *Agr. Engin. Specialist.*†Virgil Overholt, B. S., *Agr. Engin. Specialist.**P. B. Potter, B. S., C. E., *Asst. Prof. Agr. Engin.**C. O. Reed, B. S., *Prof. Agr. Engin.*†H. P. Twitchell, B. S., *Asst. in Agr. Engin.***Extension (Admin.):** †Director Ramsower in
charge.†G. B. Crane, B. S., *Asst. Dir. and Secy.*†Minnie Price, B. S., *State Home Dem. Leader.*†W. H. Palmer, M. S., *State Club Leader.*†F. L. Allen, *Supvr. of Insts. and Ext. Schools.*†W. W. Brownfield, B. S., *Dist. Supr.*†G. R. Eastwood, B. S., *Dist. Supr.*†D. S. Myer, B. S., *Dist. Supr.*†B. B. Spohn, B. S., *Dist. Supr.*†Blanche B. Bowers, B. S., *Asst. State Home Dem. Leader.*†M. W. Brady, B. S., *Asst. State Club Leader.*†O. C. Croy, B. S., *Asst. State Club Leader.*†Guy Dowdy, B. S., *Asst. State Club Leader.*†Signe Freestrom, B. S., *Asst. State Home Dem. Leader.*†Hulda E. Horst, B. S., *Asst. State Club Leader.***Farm Crops:** *J. B. Park, D. Sc., *Head of Dept.**H. L. Borst, M. S., *Instr. Farm Crops.**J. S. Cutler, M. S., *Asst. in Farm Crops.*†W. E. Hanger, B. S., *Farm Crops Specialist.*†Earl Jones, M. S., *Farm Crops Specialist.**R. H. Livingston, *Asst. in Farm Crops.*†E. P. Reed, B. S., *Farm Crops Specialist.**C. J. Willard, M. S., *Asst. Prof. Farm Crops.***Home Economics:** *Faith R. Lanman, B. S.,
*Head of Dept.**Maude G. Adams, B. S., *Prof. Home Econ.**Clara Bancroft, B. S., *Instr. Voc. Home Econ.*†Geneva M. Bane, B. S., *Home Mgt. Specialist.**Kathryn Bazole, B. S., *Instr. Home Econ.*†Jeanette Butler, B. S., *Clothing Specialist.*†Edna Callahan, B. S., *Clothing Specialist.**Alice M. Donnelly, B. S., *Instr. Home Econ.*

†Matter workers see the respective division, i. e., animal industry, botany, etc.

Home Economics—Continued.

- *June Findley, M. A., *Asst. Prof. Home Econ.*
 †Alma L. Garvin, B. S., *Nutr. Specialist.*
 *Henrietta Gromme, B. S., *Asst. Prof. Voc. Home Econ.*
 *Laurentzia S. Hansen, Ph. B., *Instr. Home Econ.*
 *Hazel Huston, B. S., *Instr. Home Econ.*
 *Almeda Jones, B. S., *Instr. Home Econ.*
 *Lelia M. McGuire, M. S., *Instr. Home Econ.*
 *Hughina McKay, M. A., *Asst. Prof. Home Econ.*
 †Lelia Ogle, *Nutr. Specialist.*
 †Wanda Przyluska, B. S., *Home Econ. Specialist.*
 *Marion Smith, B. S., *Instr. Home Econ.*
 *Elsie Steiger, B. S., *Instr. Home Econ.*
 *Grace G. Walker, B. S., *Prof. Home Econ.*

Horticulture: *Wendell Paddock, M. S., Head of Dept.

- ‡F. H. Beach, B. S., *Hort. Specialist.*
 †F. G. Charles, B. S., *Instr. Hort.*
 †N. W. Glines, B. S., *Veg. Gard. Specialist.*
 *A. C. Hottes, M. S., *Asst. Prof. Hort.*
 *L. M. Montgomery, M. S., *Prof. Hort.*
 *John Morrison, *Asst. Hort.*
 *F. J. Rimoldi, M. S., *Asst. Prof. Landsc. Arch.*
 *N. W. Scherer, B. S., *Asst. Prof. For.*
 *W. R. Sears, B. S., M. L. A., *Prof. Landsc. Arch.*
 *A. D. Taylor, M. S., *Prof. Landsc. Arch. (non-resident).*

Journalism: †J. E. McClintock, B. S., Editor.

- ‡John Fleming, B. S., *Asst. Editor.*
 *†Russell Lord, B. S., *Asst. Editor.*
 †C. E. Wilson, A. B., *Asst. in Photog. and Illustrations.*

Ohio Agricultural Experiment Station, Wooster.

†Station staff.

†C. G. Williams, *Director. Chief Agron.***Agronomy: Director Williams in charge.**

- †C. E. Dike, B. S., *Asst. in Agron.*
 †J. B. Park, D. Sc., *Assoc. Agron. (P. O., Columbus).*
 †C. A. Patton, *Asst. Agron. and Climat. Observer.*
 †L. E. Thatcher, Ph. G., *Assoc. Agron.*
 †F. A. Welton, M. S., *Assoc. Agron.*

Animal Industry: †Gustav Bobstedt, M. S., Chief in An. Indus.

- †D. S. Bell, B. S., *Asst. in An. Indus.*
 †R. M. Bethke, Ph. D., *Nutr. Chem.*
 †B. H. Edgington, M. D. C., D. V. M., *Assoc. in An. Indus.*
 †C. H. Hunt, A. M., *Asst. in An. Indus. (Nutr. Work).*
 †D. C. Kennard, Ph. C., B. S., *Assoc. in An. Indus. in charge Poultry Invest.*
 †W. L. Robison, M. S., *Asst. in An. Indus.*
 †P. S. White, B. S., *Asst. in An. Indus.*
 †A. R. Winter, M. S., *Asst. in An. Indus.*

Botany: †H. C. Young, Ph. D., Chief Bot.

- †Freda Detmers, Ph. D., *Asst. Bot.*
 †True Houser, B. S., *Asst. Bot. (P. O. German-town).*

Soils: *F. E. Bear, Ph. D., Head of Dept.

- ‡E. E. Barnes, B. S., *Soils Specialist.*
 *G. W. Conrey, Ph. D., *Asst. Prof. Soils.*
 *G. M. McClure, M. S., *Instr. Soils and Soil Chem.*
 †R. M. Salter, M. S., *Soils Specialist.*
 †J. A. Slipper, B. S., *Soils Specialist.*
 *C. L. Thrash, M. S., *Instr. Soils.*

Veterinary Medicine: Dean White in charge.

- *O. V. Brumley, V. S., *Prof. Vet. Surg., Dir. of Clinics.*
 *G. W. Bond, D. V. M., *Asst. in Bact.*
 *L. W. Goss, D. V. M., *Prof. Vet. Path.*
 *J. D. Grossman, D. V. M., *Prof. Vet. Anat.*
 *R. A. Hendershott, D. V. M., *Instr. Vet. Path.*
 *W. R. Hobbs, D. V. M., *Asst. Prof. Vet. Surg.*
 *R. E. Rebrassier, D. V. M., *Instr. Vet. Path.*
 *Septimus Sisson, S. B., D. V. S., *Prof. Comp. Anat.*
 *J. N. Shoemaker, D. V. M., *Asst. Prof. Vet. Med.*
 *J. H. Snook, D. V. M., *Prof. Vet. Surg.*

Zoology and Entomology: *R. C. Osburn, Ph. D., Head of Dept.

- *W. M. Barrows, D. Sc., *Prof. Zool.*
 *D. M. DeLong, Ph. D., *Prof. Ent.*
 *L. F. Edwards, M. S., *Instr. Zool.*
 *J. S. Hine, B. S., *Assoc. Prof. Zool., Ent.*
 *C. H. Kennedy, Ph. D., *Asst. Prof. Ent.*
 *W. J. Kostir, M. S., *Asst. Prof. Zool.*
 *F. H. Krecker, Ph. D., *Prof. Zool.*
 *Herbert Osborn, D. Sc., *Research Prof. Zool., Ent.*
 †T. H. Parks, B. S., *Ent. Specialist.*
 *Edna L. Patterson, M. S., *Asst. in Zool.*
 *Mary Waters, A. B., *Asst. in Zool.*
 *E. L. Wickliff, M. S., *Instr. Zool.*

Botany—Continued.

- †R. C. Thomas, M. A., *Asst. Bot.*
 †P. E. Tilford, B. S., *Asst. in Bot.*
 †W. J. Young, M. S., *Asst. Bot.*
Chemistry: †J. W. Ames, M. S., *Chief Chem. and Assoc. in Soil Chem.*
 †Mabel K. Corbould, B. S., *Asst. Chem. (Milling and Baking Tech.).*
 †V. H. Morris, M. A., *Asst. Chem. (Agron.).*
 †C. J. Schollenberger, *Asst. Chem.*
 †R. H. Simon, A. M., *Asst. Chem.*

Dairy Industry: †C. C. Hayden, M. S., Chief in Dairying.

- †C. F. Monroe, M. S., *Asst. Dairy Chem.*
 †A. E. Perkins, M. S., *Asst. Dairy Chem.*

Entomology: †H. A. Gossard, M. S., Chief Ent.

- †C. R. Cutright, M. S., *Asst. Ent.*
 †J. S. Houser, M. S., *Assoc. Ent.*
 †L. L. Huber, Ph. D., *Asst. Ent.*
 †A. E. Miller, M. S., *Asst. Ent. (P. O., Chillicothe).*
 †C. R. Neiswander, M. S., *Asst. Ent.*
 †Herbert Osborn, D. Sc., *Assoc. Ent. (P. O., Columbus).*

Forestry: †Edmund Secret, B. S., *Chief For. and Assoc. Dir. of Sta.*

†O. A. Alderman, M. F., *Asst. in For.*

†J. J. Crumley, Ph. D., *Asst. For.*

†F. W. Dean, B. S., *Asst. For.*

†B. E. Leete, M. F., *Asst. For. (P. O., Portsmouth).*

Farm Management: †C. W. Montgomery, *Chief in Farm Mgt.*

†L. B. Nettleton, *Asst. in Farm Mgt.*

Horticulture: †J. H. Gourley, M. S., *Chief Hort.*

†F. H. Ballou, *Assoc. Hort. (P. O., Newark).*

†J. W. Bushnell, M. S., *Asst. Hort.*

†C. W. Ellenwood, *Asst. Hort.*

†W. J. Green, *Consult. Hort.*

†I. P. Lewis, B. S., *Asst. in Hort.*

†Roy Magruder, B. S., *Asst. Hort.*

†W. F. Rofkar, B. S., *Asst. Hort.*

Soils: †C. E. Thorne, M. S. A., *Chief in Soil Fert. Invest.*

†L. D. Baver, B. S., *Asst. in Soils.*

†F. E. Bear, Ph. D., *Assoc. in Soil Invest. (P. O., Columbus).*

†A. Bonazzi, B. Agr., *Asst. Soil Tech.*

†G. W. Conrey, Ph. D., *Asst. in Soil Survey (P. O., Columbus).*

†I. H. Curie, B. S., *Asst. in Soils.*

†T. C. Green, *Asst. in Soils.*

Miscellaneous:

†W. H. Alexander, *Climat. (Detailed by U. S. D. A.: P. O., Columbus).*

†W. K. Greenbank, *Editor.*

Miscellaneous—Continued.

†W. H. Kramer, *Bursar.*

†Margaret Williams, A. B., *Libr.*

Substations: C. W. Montgomery, *Chief.*

Northeastern Test Farm, *Strongsville, J. T. Wilson, Foreman.*

Northwestern Test Farm, *Findlay, J. A. Sutton, Mgr.*

Southeastern Test Farm, *Carpenter, ———, Mgr.*

Southwestern Test Farm, *Germantown, H. M. Wachter, Mgr.*

Belmont Co. Expt. Farm, *St. Clairsville, G. M. DeGroft, B. C. S., Mgr.*

Clermont Co. Expt. Farm, *Owensville, W. E. Weaver, Supt.*

Hamilton Co. Expt. Farm, *Mt. Healthy, W. E. Weaver, Supt.*

Madison Co. Expt. Farm, *London, H. W. Rogers, Supt.*

Mahoning Co. Expt. Farm, *Canfield, A. W. Nettleton, Supt.*

Miami Co. Expt. Farm, *Troy, H. W. Rogers, Supt.*

Paulding Co. Expt. Farm, *Paulding, H. R. Hoyt, Supt. (P. O., Wooster).*

Trumbull Co. Expt. Farm, *Cortland, A. W. Nettleton, Supt.*

Washington Co. Expt. Farm, *Marietta, S. C. Hartman, Supt.*

Washington Co. Truck Farm, *Fleming, S. C. Hartman, Supt.*

OKLAHOMA.

Oklahoma Agricultural and Mechanical College and the Agricultural Experiment Station, Stillwater.

*College faculty. †Station staff. ‡Extension staff.

*Bradford Knapp, LL. B., D. Agr., *President.*

*†C. T. Dowell, Ph. D., *Actg. Dean of Agr., Dir. of Sta.*

‡E. A. Miller, M. S., *Dir. of Ext.*

E. P. Boyd, B. S., *Dean School of Engin.*

Agronomy: *†Adrian Daane, M. S., *Prof. Agron.; Agron.*

*†Glen Briggs, M. S., *Assoc. Prof. and Assoc. Agron.*

†H. H. Finnell, B. S., *Assoc. in Agron. (P. O., Goodwell).*

†G. C. Gibbons, B. S., *Ext. Agron.*

*Clyde Haston, B. S., *Instr. Voc. Agron.*

*†H. F. Murphy, M. S., *Assoc. Prof. and Assoc. Agron.*

*†H. C. Potts, B. S., *Asst. Prof. and Asst. Agron.*

Animal Industry: *†W. L. Blizzard, B. S., *Prof. An. Husb.; An. Husb.*

*†A. C. Baer, B. S., *Prof. Dairy Husb.; Dairyman.*

*†R. B. Thompson, B. S., *Prof. Poultry Husb.; Poultryman.*

†J. W. Boehr, M. S., *Dairy Husb. Ext.*

*†A. D. Burke, M. S., *Assoc. Prof. and Assoc. Dairy Husb.*

*O. C. Cooper, B. S., *Asst. in Dairying and Herdsman.*

*†W. A. Craft, M. S., *Asst. Prof. An. Husb.; in charge Brdg. Work.*

Animal Industry—Continued.

*†A. E. Darlow, M. S., *Assoc. Prof. An. Husb.; in charge Sheep.*

*†H. E. Doty, B. S., *Asst. Prof. and Asst. Dairy Husb.*

†Clyde Ingram, *Asst. Ext. Poultryman.*

*†E. R. Lawrence, B. S., *Asst. Prof. and Asst. Dairy Husb.*

†P. H. Lowery, B. S., *Ext. An. Husb.*

*†H. R. Naylor, B. S., *Asst. Prof. and Asst. Poultryman.*

†Robert Penquite, B. S., *Supt. of Poultry Farm.*

*L. L. Perry, B. S., *Instr. Voc. An. Husb.*

*F. M. Shields, B. S., *Instr. Dairy Husb.*

*†C. P. Thompson, M. S., *Assoc. Prof. An. Husb.; in charge Swine.*

*Charles Upp, B. S., *Instr. Voc. Poultry Husb.*

*V. O. Wilson, Ph. B., *Asst. Prof. and Asst. Poultryman.*

Botany: *†C. O. Chambers, Ph. D., *Prof. Bot.; Bot.*

*†Robert Stratton, M. A., *Asst. Prof. and Asst. Bot.*

Chemistry: Director Dowell in charge.

- *O. M. Smith, Ph. D., *Prof., Chem. and Chem. Engin.*
 *Robert DuBois, M. S., *Assoc. Prof. Chem.*
 †W. D. Gallup, B. S., *Asst. Chem.*
 †P. L. Menaull, A. M., *Assoc. Research Chem.*
 *C. L. Nickolls, M. S., *Assoc. Prof. Chem.*
 *N. H. Sturgis, B. S., *Instr. Chem.*
 *S. R. Wood, M. S., *Asst. Prof. Chem.*

Economics (Rural): *M. E. Andrews, M. S., *Prof. Rural Econ. and Sociol.*

- ‡G. W. Vincent, *Organ. and Marketing Specialist.*

Education (Agr.): *O. M. Clark, B. S., *Prof. Agr. Ed.*

- *L. W. Littlejohn, B. S., *Asst. Prof. Agr. Ed.*

Engineering (Agr.): *L. E. Hazen, M. E., *Prof. Rural Engin.*

- ‡W. H. McPheeters, B. S., *Farm Engin. Specialist.*

Entomology: *†C. E. Sanborn, M. A., *Prof. Ent.; Ent.*

- *†G. A. Bieberdorf, B. S., *Instr. and Asst. Ent.*
 *†W. E. Jackson, M. S., *Asst. Prof. and Asst. Ent.*
 †E. E. Scholl, B. S., *Ext. Ent.*
 *R. O. Whinton, M. S., *Assoc. Prof. Zool.*

Extension (Admin.): Director Miller in charge.

- ‡W. D. Bentley, *Asst. Dir.*
 †W. R. Shelton, *State Agt.*
 †Frances L. Brown, B. S., *State Home Dem. Agt.*
 †B. A. Pratt, M. S., *State Club Agt.*
 †Daisy M. Frazier, *Asst. State Club Agt.*

Home Economics: *Nora A. Talbot, A. M., *Dean School of Home Econ., Head of Teacher Training.***Home Economics—Continued.**

- *Hilda Brockman, B. S., *Instr. Nursing.*
 *Ethel Davis, B. S., *Prof. Household Art.*
 *Mary Diehl, *Instr. Household Admin.*
 *Madonna Fitzgerald, B. S., *Instr. Household Sci.*
 *Lydia M. Hoffman, B. S., *Assoc. Prof. Household Sci.*
 †Martha R. McPheeters, B. S., *Nutr. Specialist.*
 *Ruth Meyers, B. S., *Supvr. Voc. Home Econ.*
 †Jessie S. Pollock, *Clothing Specialist.*
 *Louise Pritchett, B. S., *Prof. Household Sci.*
 *Ruth Remund, A. M., *Assoc. Prof. Teacher Training.*
 *Anna M. Rhodes, A. M., *Assoc. Prof. Household Art.*

Horticulture: *†G. W. Cochran, M. S., *Prof. Hort.; Hort.*

- *†F. B. Cross, B. S., *Assoc. Prof. and Assoc. Hort.*
 *Christian Jensen, B. F., *For. and Landsc. Gard.*
 *†E. D. Markwell, B. S., *Asst. Prof. and Asst. Hort.*
 †D. C. Mooring, M. S., *Ext. Hort.*
 *†D. V. Shuhart, B. S., *Asst. Prof. and Asst. Hort.*

Veterinary Science: *†C. H. McElroy, B. S., D. V. M., *Prof. Vet. Med. and Bact.; Vet. and Bact.*

- *E. E. Harnden, B. S., D. V. M., *Asst. Prof. Vet. Med.*
 *H. W. Orr, D. V. M., *Assoc. Prof. Bact. and Vet. Med.*

Miscellaneous:

- *E. E. Hadley, A. B., *Editor of Pubs.*

Agricultural and Normal University, Langston.

*Agricultural faculty.

*I. W. Young, *President.*

- *Mrs. Ivy Butler, *Asst. in Home Econ.*
 *A. H. Fuhr, *Asst. in Agr.*
 *T. H. Jackson, B. S., *Dir. of Agr.*
 *D. W. Lee, B. S., *Asst. in Agr.*
 *Mrs. Evah S. Lowe, *Asst. in Home Econ.*

- *B. M. Mathis, B. S., *Asst. in Agr.*
 *R. N. Pyrtle, A. M., *Biol.*
 *Mrs. G. S. Ricks, B. S., *Dir. of Home Econ.*
 *Miss I. E. Wade, B. S., *Chem.*
 *Mrs. Janett P. Wess, B. S., *Asst. Home Econ.*

OREGON.**Oregon Agricultural College and the Agricultural Experiment Station, Corvallis.**

*College faculty. †Station staff. ‡Extension staff.

- *W. J. Kerr, D. Sc., LL. D., *President.*
 *A. B. Cordley, D. Sc., *Dean School of Agr.*
 †J. T. Jardine, B. S., C. E., *Dir. of Sta.*
 †P. V. Maris, B. S., *Dir. of Ext. Service.*
 G. A. Covell, M. E., *Dean School of Engin. and Mech. Arts.*

Animal Industry: *†E. L. Potter, M. Agr., *Prof. An. Husb.; An. Husb.*

- *†P. M. Brandt, A. M., *Prof. Dairy Husb.; Dairy Husb.*
 *†A. G. Lunn, M. S., *Prof. Poultry Husb.; Poultry Husb.*
 *E. E. Anderson, B. S., *Instr. An. Husb.*
 *V. D. Chappell, M. S., *Asst. Prof. Dairy Husb.*
 *H. N. Colman, B. S., *Instr. Dairy Husb.*

Animal Industry—Continued.

- †H. E. Cosby, *Poultry Husb. Specialist.*
 *F. E. Fox, B. S., *Asst. Prof. Poultry Husb.*
 †N. C. Jamison, B. S., *Dairy Specialist.*
 *†R. C. Jones, B. S., *Assoc. Prof. and Assoc. Dairy Husb.*
 †F. L. Knowlton, B. S., *Research Asst. in Poultry Husb.*
 †H. A. Lindgren, B. S., *An. Husb. Specialist.*

† For subject-matter workers see the respective division, i. e., agronomy, animal industry, etc.

Animal Industry—Continued.*†O. M. Nelson, B. S., *Prof. and Assoc. An. Husb.**†A. W. Oliver, B. S., *Asst. Prof. and Asst. An. Husb.**B. W. Rodenwold, B. S., *Asst. Prof. An. Husb.***Bacteriology:** *†G. V. Copson, M. S., *Prof. Bact.; Bact.**J. A. Berry, M. S., *Instr. Bact.**†W. V. Halversen, M. S., *Asst. Prof. and Asst. Bact.**J. E. Simmons, M. S., *Asst. Prof. Bact.***Botany and Plant Pathology:** *†H. P. Barss, M. S., *Prof. and Chief in Bot. and Plant Path.**W. M. Atwood, Ph. D., *Assoc. Prof. Plant Physiol.**Helen M. Gilkey, Ph. D., *Asst. Prof. Bot., Curator of Herbarium.*†Bertha C. Hite, B. A., *Seed Analyst (Detailed by U. S. D. A.).**W. E. Lawrence, B. S., *Assoc. Prof. Plant Path.*†M. B. McKay, M. S., *Assoc. Plant Path.**C. E. Owens, M. A., *Assoc. Prof. Bot. and Plant Path.*†S. M. Zeller, Ph. D., *Assoc. Plant Path.***Chemistry:** *†J. S. Jones, M. S., *Prof. Agr. Chem.; Chem.*†D. E. Bullis, B. S., *Asst. Chem. in Research.**H. R. Kelly, B. S., *Instr. Agr. Chem.*†H. G. Miller, Ph. D., *Assoc. in Agr. Chem. Research.*†R. H. Robinson, M. S., *Assoc. Chem. in Research.**Walter Scott, Ph. D., *Assoc. Prof. Chem.*†W. W. Yates, B. S., *Asst. Chem.***Economics and Farm Management:** *†Hector Macpherson, Ph. D., *Prof. Econ., Dir. Bureau of Organ. and Markets.**†H. D. Scudder, B. S., *Prof. and Chief in Farm Mgt.*†R. S. Besse, M. A., *Farm Mgt. Dem.**N. H. Comish, M. S., *Prof. Econ.**W. H. Dreesen, Ph. D., *Asst. Prof. Econ. and Sociol.*†C. J. Hurd, *Specialist in Organ. and Markets.**Clair Wilkes, B. S., *Instr. Farm Mgt.***Education (Agr.):** *H. H. Gibson, A. M., *Prof. Agr. Ed.**F. P. Osborn, *Instr. Agr. Ed.**O. G. Reeves, B. S., *Instr. Voc. Ed.***Engineering (Agr.):** *W. J. Gilmore, B. S. A. E., *Prof. Farm Mech.**H. S. Rogers, B. S., *Prof. Irrig. Engin.**G. V. Skelton, C. E., *Prof. Highway Engin.**A. E. Jensen, *Instr. Farm Mech.*†G. W. Kable, B. S., *Agr. Engin. Specialist.***Entomology:** *†A. L. Lovett, B. S., *Prof. Ent.; Ent.**†W. J. Chamberlin, M. S., *Asst. Prof. Ent.; For. Ent.**†B. B. Fulton, M. S., *Asst. Prof. and Assoc. Ent.**†D. C. Mote, M. S., *Assoc. Prof. and Assoc. Ent.**†H. A. Scullen, A. B., *Asst. Prof. Ent.***Extension (Admin.):**¹ Director Maris in charge.†F. L. Ballard, B. S., *County Agt. Leader.*†Jessie D. McComb, A. M., *State Home Dem. Leader.*†H. C. Seymour, *State Leader of Indus. Clubs.*†L. J. Allen, M. S., *Asst. State Club Leader.*†Helen J. Cowgill, B. S., *Asst. State Home Dem. Leader.*†W. L. Kadderly, B. S., *in charge Information and Exhibits.***Farm Crops:** *†G. R. Hyslop, B. S., *Prof. Farm Crops; Farm Crops Specialist.**†E. N. Bressman, B. S., *Assoc. Prof. Agron. Agron.*†E. R. Jackman, B. S., *Farm Crops Specialist.**R. G. Larson, B. S., *Instr. Farm Crops.**†C. C. Ruth, M. S., *Asst. Prof. Farm Crops; Asst. Farm Crops Specialist.*†H. A. Schoth, M. S., *Asst. in Farm Crops (Coop. U. S. D. A.).*†H. M. Woolman, *Field Asst. in Cereal Invest. (Detailed by U. S. D. A.).***Home Economics:** *Ava B. Milam, M. A., *Dean School of Home Econ.**Lula M. Brandt, B. S., *Instr. Household Art.**Amelia E. Burns, B. S., *Instr. Household Sci.*†Esther B. Cooley, B. S., *Asst. in Clothing.**Helen L. Davis, B. S., *Prof. Household Art.**Elizabeth Flora, B. S., *Instr. Institutional Mgt.**Sibylla Hadwen, *Prof. Institutional Mgt.**Marion Hodgson, B. S., *Instr. Household Art.**Alma G. Johnson, B. S., *Prof. Household Admin.**Lura A. Keiser, B. S., *Instr. Home Econ. Ed.**Ruth H. Kennedy, B. S., *Instr. Household Sci.**Helen McFaul, B. A., *Instr. Household Art.**Margaret C. Morehouse, B. S., *Instr. Household Art.**Lila M. O'Neale, B. S., *Asst. Prof. Household Art.**Sara W. Prentiss, B. S., *Instr. Household Admin.**Dorothy Shank, B. S., *Assoc. Prof. Home Econ. Ed.*†Margery M. Smith, B. S., *Nutr. Specialist.**Blanche W. Stevens, B. S., *Instr. Household Art.**Gertrude Strickland, *Instr. Household Art.**Lilian C. Taylor, B. S., *Instr. Household Art.**Mary S. Van Kirk, *Instr. Household Art.**†Hjeta Vassanoja, B. S., *Instr. Institutional Mgt.**Bernice C. Wait, M. S., *Instr. Household Sci.**Emma S. Weld, Ph. B., *Instr. Household Admin.**Gladys L. Whipple, B. S., *Instr. Home Econ. Ed.**Jessamine C. Williams, B. S., *Prof. Household Sci.**Louise Wood, B. S., *Supvr. Voc. Home Econ.*¹ For subject-matter workers see the respective division, i. e., animal industry, bacteriology, etc.

Horticulture: *†W. S. Brown, M. S., *Prof. and Chief in Hort.*

*J. C. Bell, M. S., *Instr. Hort. Products.*

*†A. G. B. Bouquet, B. S., *Prof. Veg. Gard.; Hort.*

*†Henry Hartman, M. S., *Assoc. Prof. and Asst. Hort. (Pomol.).*

*†E. M. Harvey, Ph. D., *Prof. and Research Hort.*

†C. L. Long, M. S., *Hort. Specialist.*

†A. E. Murneek, M. S., *Research Asst. in Hort.*

*A. L. Peck, B. S., *Prof. Landsc. Gard. and Flor.*

*†C. E. Schuster, M. S., *Assoc. Prof. and Asst. Hort. (Pomol.).*

*†E. H. Wiegand, B. S., *Prof. Hort. Products; Hort.*

*L. P. Wilcox, B. S., *Instr. Hort.*

Journalism: *F. L. Snow, *Prof. Journalism.*

*†C. J. McIntosh, B. S., *Agr. Press Editor.*

*†E. T. Reed, B. S., *Editor.*

Soils: *†W. L. Powers, M. S., *Prof. and Chief in Soils.*

*†W. W. Johnston, B. S., *Asst. Prof. and Asst. in Soils (Irrig.).*

†F. E. Price, B. S., *Soils Specialist.*

*†C. V. Ruzek, B. S., *Prof. and Assoc. in Soils (Fert.).*

*†R. E. Stephenson, Ph. D., *Assoc. Prof. and Assoc. Soils Specialist.*

*†E. F. Torgerson, B. S., *Asst. Prof. Soils; Asst. in Soil Survey.*

Veterinary Medicine: *†B. T. Simms, D. V. M., *Prof. Vet. Med.; Vet.*

*C. R. Donham, D. V. M., *Instr. Vet. Med.*

Veterinary Medicine—Continued.

*†F. W. Miller, M. S., D. V. M., *Asst. Prof. and Asst. Vet.*

Zoology and Physiology: *Nathan Fasten, Ph. D., *Prof. Zool. and Physiol.*

*Florence S. Hague, Ph. D., *Instr. Zool. and Physiol.*

*J. E. Lynch, *Instr. Zool.*

*†H. M. Wight, M. S., *Prof. Zool. and Physiol.; Asst. Zool.*

Miscellaneous:

*Lucy M. Lewis, B. L. S., *Libr.*

Substations:

Dry-Farm Branch Sta., *P. O., Moro—*
D. E. Stephens, B. S., *Supt. (Coop. U. S. D. A.).*

B. B. Bayles, B. S., *Junior Plant Breeder (Coop. U. S. D. A.).*

Eastern Ore. Branch Sta., *P. O., Union—*
Robert Withycombe, B. S., *Supt.*

F. M. Edwards, B. S., *Asst. An. Husb.*

H. N. Wautenpaugh, B. S., *Asst. Farm Crops Specialist.*

Harney Valley Branch Sta., *P. O., Burns—*
Obil Shattuck, M. S., *Supt.*

Hood River Branch Sta., *P. O., Hood River—*
LeRoy Childs, B. A., *Supt. and Ent.*

G. G. Brown, B. S., *Hort.*

John Jacob Astor Branch Sta., *P. O., Astoria—*
A. E. Engbretson, B. S., *Supt.*

Southern Ore. Branch Sta., *P. O., Talent—*
F. C. Reimer, M. S., *Supt.*

Umatilla Branch Sta., *P. O., Hermiston—*
H. K. Dean, B. S., *Supt.*

Harry Humfeld, B. S., *Asst to Supt*

PENNSYLVANIA.

The School of Agriculture and Agricultural Experiment Station and the Department of Home Economics of the Pennsylvania State College,¹ State College.

*College faculty. †Station staff. ‡Extension staff.

*J. M. Thomas, D. D., LL. D., *President of College.*

*†R. L. Watts, D. Agr., *Dean School of Agr., Dir. of Sta.*

†M. S. McDowell, M. S., *Dir. Agr. Ext.*

R. L. Sackett, C. E., *Dean School of Engin., Dir. Engin. Expt. Sta.*

Agronomy: *†F. D. Gardner, B. S., *Head of Dept.*

*†C. O. Cromer, B. S., *Prof. Farm Crops.*

*†C. F. Noll, Ph. D., *Prof. Expt. Agron.*

*†J. W. White, M. S., *Prof. Soil Tech.*

*†J. S. Cobb, M. S., *Asst. Prof. Agron.*

*†J. B. R. Dickey, B. S., *Asst. Prof. Agron. Ext.*

*†F. J. Holben, B. S., *Asst. Prof. Soil Tech.*

*†C. J. Irvin, B. S., *Asst. in Expt. Agron.*

*†R. D. Lewis, B. S., *Instr. Agron.*

*†F. G. Merkle, M. S., *Asst. Prof. Soil Tech.*

*†H. B. Musser, B. S., *Asst. Prof. Agron. Ext.*

*†A. L. Patrick, M. S., *Assoc. Prof. Soil Tech.*

*†J. D. Romaine, B. S., *Asst. in Soil Tech.*

*†Nikolas Schmitz, M. S., *Prof. of Agron. Ext.*

*†E. J. Walter, B. S., *Asst. Prof. Agron. Ext.*

Animal and Poultry Husbandry: *†W. H. Tomhave, M. S., *Head of Dept. An. Husb.*

*†H. C. Kandel, B. S., *Head Dept. of Poultry Husb.*

*†F. L. Bentley, M. S., *Prof. An. Husb.*

Animal and Poultry Husbandry—Continued.

*M. F. Grimes, M. S., *Prof. An. Husb.*

*†L. M. Black, B. S., *Instr. Poultry Husb.*

*†M. H. Brightman, B. S., *Asst. Prof. Poultry Husb.*

*†P. T. Brown, B. S., *Asst. Prof. An. Husb. Ext.*

*†W. B. Connell, M. S., *Assoc. Prof. An. Husb. Ext.*

*†P. L. Fatout, M. S., *Instr. An. Husb.*

*†D. M. Gray, B. S., *Instr. Poultry Husb. Ext.*

*†H. H. Havner, D. V. M., M. S., *Prof. An. Husb. Ext.*

*†W. L. Henning, M. S., *Instr. An. Husb.*

*†P. T. Kistler, B. S., *Asst. in Poultry Husb.*

*†P. C. Mackenzie, *Asst. in An. Husb.*

*†L. C. Madison, B. S., *Asst. Prof. An. Husb. Ext. (Swine).*

*†H. D. Munroe, B. S., *Prof. Poultry Husb. Ext.*

*†J. F. Shigley, D. V. M., *Asst. Prof. Vet. Sci.*

*†L. W. Steelman, B. S., *Instr. Poultry Husb. Ext.*

*†J. M. Vial, B. S., *Asst. Prof. An. Husb. Ext.*

*†P. T. Ziegler, M. S., *Instr. An. Husb.*

¹This institution gives the academic title to all employees.

- Botany:** *†F. D. Kern, Ph. D., *Head of Dept.*
 *†J. B. Hill, Ph. D., *Prof. Bot.*
 *†C. R. Orton, M. S., *Prof. Plant Path.*
 *†J. P. Kelly, Sc. D., *Assoc. Prof. Bot.*
 *†R. S. Kirby, Ph. D., *Asst. Prof. Plant Path. Ext.*
 *†W. S. Krout, M. A., *Asst. Prof. Plant Path. Ext.*
 *†W. A. Kuntz, M. S., *Instr. Bot.*
 *†G. F. Miles, B. S., *Asst. Prof. Plant Path. Ext.*
 *†E. L. Nixon, M. S., *Prof. Plant Path. Ext.*
 *†H. W. Popp, M. S., *Asst. Prof. Bot.*
 *†L. O. Overholts, Ph. D., *Assoc. Prof. Bot.*
 *†H. W. Thurston, jr., Ph. D., *Asst. Prof. Plant Path.*
- Chemical Agriculture:** *†R. A. Dutcher, M. A., *Head of Dept.*
 *†D. E. Haley, Ph. D., *Prof. Chem. Agr.*
 *†A. K. Anderson, Ph. D., *Assoc. Prof. Chem. Agr.*
 *†E. S. Erb, M. S., *Asst. Prof. Expt. Agr. Chem.*
 *†Emma Francis, M. S., *Asst. Prof. Chem. Agr.*
 *†M. W. Lisse, M. S., *Asst. Prof. Chem. Agr.*
 *†H. B. Pierce, M. S., *Asst. Prof. Chem. Agr.*
 *†E. S. Reider, Phar. G., *Instr. Chem. Agr.*
 *†G. A. Shuey, B. S., *Instr. Chem. Agr.*
 *†Walter Thomas, B. S., *Asst. Prof. Expt. Agr. Chem.*
- Dairy Husbandry and Bacteriology:** *†A. A. Borland, M. S., *Head of Dept.*
 *†A. L. Beam, M. S., *Prof. Dairy Prod.*
 *†S. I. Bechdel, M. S., *Prof. Dairy Husb.*
 *†S. J. Brownell, B. S., M. Agr., *Asst. Prof. Dairy Husb. Ext.*
 *†W. B. Combs, M. S., *Assoc. Prof. Dairy Husb.*
 *†E. B. Fitts, B. S., *Prof. Dairy Husb. Ext.*
 *†C. R. Gearhart, B. S., *Asst. Prof. Dairy Husb. Ext.*
 *†George Kernohan, D. V. M., *Asst. Prof. Bact.*
 *†I. R. Knapp, M. S., *Instr. Dairy Husb.*
 *†F. P. Knoll, *Asst. in Dairy Mfrs.*
 *†M. H. Knutsen, M. S., *Assoc. Prof. Bact.*
 *†W. H. Martin, M. S., *Asst. Prof. Dairy Mfrs.*
 *†L. W. Morley, M. S., *Assoc. Prof. Dairy Husb. Ext.*
 *†R. H. Olmstead, M. S., *Asst. Prof. Dairy Husb. Ext.*
 *†I. O. Sidelmann, *Asst. in Dairy Husb. Ext.*
 *†A. C. Simpson, B. S., *Asst. Prof. Bact.*
 *†W. D. Swope, B. S., *Asst. Prof. Dairy Husb.*
 *†P. S. Williams, B. S., *Instr. Dairy Husb.*
- Economics (Agr.):** *†R. G. Bressler, M. S., *Head of Dept. Prof. Rural Sociol.*
 *†W. V. Dennis, A. B., *Assoc. Prof. Rural Sociol.*
 *†W. R. Gordon, B. S., *Asst. Prof. Rural Sociol. Ext.*
 *†J. L. E. McCord, M. S., *Assoc. Prof. Farm Mgt. and Rural Econ.*
 *†E. L. Moffitt, M. S., *Prof. Farm Mgt. Ext.*
 *†H. G. Niesley, M. S., *Prof. Agr. Econ. Ext.*
 *†H. S. Sloat, B. S., *Asst. in Farm Mgt. Ext.*
- Entomology:** *†H. E. Hodgkiss, B. S., *Prof. Ent. Ext.*
 *†N. E. Phillips, B. S., *Asst. Prof. Ent. Ext.*
 *†D. L. Van Dine, B. S., *Asst. Prof. Ent. Ext.*
- Extension (Admin.):** † Director McDowell in charge, and County Agt. Leader.
 *†T. I. Mairs, M. S., *Head Dept. of Corresp. Courses.*
 *†M. J. Armes, B. S., *Asst. in Farm Mgt. Ext.*
 *†A. L. Baker, B. S., *Asst. Prof. Agr. Ext.*
 *†A. S. Barnhart, B. S., *Instr. Agr. Ext.*
- Extension (Admin.)—Continued.**
 *†R. H. Bell, B. S., *Prof. Agr. Ext.*
 *†C. D. Byrne, M. S., *Asst. in Agr. Ext. (Editor).*
 *†C. E. Fox, *Asst. Coop. and Rural Organ. Ext.*
 *†F. P. Weaver, M. S., *Prof. Agr. Ext.*
 *†W. R. White, M. S., *Assoc. Prof. Corresp. Courses.*
 *†Brandon Wright, B. S., *Instr. Agr. Ext.*
- Farm Machinery:** *†R. U. Blasingame, B. S., *Head of Dept.*
 *†G. M. Foulkrod, B. S., *Asst. Prof. Farm Mach.*
 *†J. R. Haswell, C. E., *Asst. Prof. Farm Mech. Ext.*
- Farms:** *†C. L. Goodling, M. S., *Supt. of Farms and Assoc. Prof. Farm Mgt.*
- Forestry:** *†J. A. Ferguson, M. A., M. F., *Head of Dept.*
 *†G. R. Green, M. S., *Prof. Wood Utilization.*
 *†C. R. Anderson, M. F., *Assoc. Prof. For. Ext.*
 *†W. G. Edwards, M. S., *Assoc. Prof. For.*
 *†F. T. Murphey, B. S., *Asst. Prof. For. Ext.*
 *†G. F. Rupp, B. S., *Instr. For.*
- Home Economics:** *†Edith P. Chace, M. A., *Dir. of Dept.*
 *†Madge T. Bogart, B. S., *Prof. Home Econ. Ext.*
 *Anne E. Boyd, B. S., *Instr. Dom. Art.*
 *Ella J. Day, B. S., *Asst. Prof. Dom. Sci.*
 *Margaret L. Dozier, B. S., *Asst. in Dom. Sci.*
 *Ruth E. Graham, M. S., *Asst. Prof. Dom. Art.*
 *†Belle Hubbard, B. S., *Instr. Home Econ. Ext.*
 *Louise B. Moss, M. A., *Assoc. Prof. Dom. Sci.*
 *Elizabeth Richman, R. N., *Instr. Home Nursing.*
 *Evelyn E. Smith, B. S., *Instr. Dom. Sci.*
 *Louise G. Turner, M. A., *Assoc. Prof. Teacher Training in Voc. Home Econ.*
 *M. Elizabeth Westgate, M. A., *Instr. Dom. Art.*
 *Elizabeth W. Wheeler, B. S., *Instr. Dom. Sci.*
 *Sara M. Wilson, M. A., *Assoc. Prof. Dom. Sci. and Teacher Training in Voc. Home Econ.*
- Horticulture:** *†S. W. Fletcher, Ph. D., *Head of Dept.*
 *†R. D. Anthony, Ph. D., *Prof. Pomol.*
 *†A. W. Cowell, B. S., *Prof. Landsc. Arch.*
 *†F. N. Fagan, M. S., *Prof. Pomol.*
 *†C. E. Myers, Ph. D., *Prof. Plant Brdg.*
 *†W. T. Tapley, M. S., *Prof. Veg. Gard.*
 *†E. I. Wilde, M. S., *Prof. Flor.*
 *†H. E. Dahl, M. S., *Asst. Prof. Landsc. Arch.*
 *†R. W. Evans, B. S., *Instr. Hort.*
 *†F. W. Haller, *Asst. in Hort.*
 *†W. B. Mack, M. S., *Instr. Veg. Gard.*
 *†W. B. Nissley, B. S., *Prof. Veg. Gard. Ext.*
 *†R. S. Snyder, B. S., *Asst. in Pomol. Ext.*
 *†Paul Thayer, M. S., *Prof. Pomol. Ext.*
 *†J. H. Waring, M. S., *Asst. Prof. Expt. Pomol.*
- Miscellaneous:**
 *†G. A. Grant, *Instr. Photog.*
 *†Kathryne M. Stanford, *Agr. Libr.*
- Field Laboratories:**
 Arendtsville—
 *†S. W. Frost, B. S., *Assoc. Prof. Econ. Ent.*
 *†R. C. Walton, M. S., *Assoc. Prof. Plant Path. Research.*
 Bustleton—
 *†W. S. Beach, Ph. D., *Assoc. Prof. Plant Path. Research.*
 *†J. L. Horsfall, M. S., *Assoc. Prof. Econ. Ent.*

† For subject-matter workers see the respective division, i. e., agronomy, animal husbandry, etc.

Institute of Animal Nutrition of Pennsylvania State College, State College.

†Institute staff.

†E. B. Forbes, Ph. D., *Director.*

- | | |
|--|--|
| †W. W. Braman, M. S., <i>Assoc. in An. Nutr.</i> | †C. D. Jeffries, M. S., <i>Assoc. in An. Nutr.</i> |
| †D. C. Cochrane, M. S., <i>Assoc. in An. Nutr.</i> | †M. Kriss, M. S., <i>Assoc. in An. Nutr.</i> |
| †R. B. French, M. S., <i>Asst. in An. Nutr.</i> | †R. M. Meredith, B. S., <i>Asst. in An. Nutr.</i> |
| †J. A. Fries, M. S., <i>Asst. Dir.</i> | †R. W. Swift, B. S., <i>Asst. in An. Nutr.</i> |

PORTO RICO.

College of Agriculture and Mechanic Arts of the University of Porto Rico, Mayaguez.

*College faculty.

- *J. B. Huyke, *Chancellor of University (P. O., San Juan).*
 *C. E. Horne, Ph. D., *Dean of College (P. O., Mayaguez).*

- | | |
|--|---|
| *B. A. Bourne, M. S., <i>Prof. Veg. Path.</i> | *J. W. Elliott, M. S., <i>Prof. Agron.</i> |
| *H. T. Cowles, B. S., <i>Prof. Hort., Chair. of Agr. Dept.</i> | *A. A. Fix, B. S., <i>Prof. An. Husb.</i> |
| *R. E. Danforth, M. S., <i>Prof. Biol.</i> | *L. C. Monzón, B. S., <i>Asst. Prof. Chem.</i> |
| *M. R. Diaz, B. S., <i>Asst. Sugar Chem.</i> | *M. A. del Valle, B. S. in Ch. E., <i>Prof. Sugar Chem.</i> |
| *T. E. Dunlap, M. S., <i>Prof. Chem.</i> | *F. J. Walrath, B. S., <i>Prof. Agr. Econ.</i> |

Agricultural Experiment Station, Mayaguez.

Under the supervision of the Office of Experiment Stations, United States Department of Agriculture.

†Station staff.

†D. W. May, M. Agr., *Agronomist in charge.*

- | | |
|--|--|
| †J. O. Carrero, B. S. Ch. E., <i>Asst. Chem.</i> | †T. B. McClelland, A. B., <i>Hort.</i> |
| †R. L. Davis, A. M., <i>Plant Breeder.</i> | †J. A. Saldana, B. S., <i>Asst. in Hort.</i> |
| †H. C. Henriksen, B. Agr., <i>Specialist in Farm Mgt. (P. O., San Juan).</i> | _____, <i>Ent.</i> |
| | †C. M. Tucker, B. S., <i>Plant Path.</i> |

Insular Experiment Station, Rio Piedras.

Under the control of the Department of Agriculture and Labor of Porto Rico.

†Station staff.

†R. M. Ramos, M. S., *Director.*

- | | |
|--|---|
| †M. T. Cook, Ph. D., <i>Tech. in Plant Path.</i> | †Pedro Richardson, B. S., <i>Chief Div. of Agron.</i> |
| †J. P. Griffith, M. S., <i>Plant Breeder.</i> | †Alfonso Rivera, D. V. S., <i>Vet. and An. Husb.</i> |
| †F. A. López, B. S., <i>Chief Div. of Chem.</i> | †Francisco Sein, jr., B. S., <i>Asst. Ent.</i> |
| †F. C. Moret, B. S., <i>Assoc. Chem.</i> | †B. A. Toro, B. S., <i>Asst. Path.</i> |
| †Pedro Osuna, B. S., <i>Hort.</i> | †G. N. Wolcott, M. S., <i>Chief Div. of Ent.</i> |
| †J. H. Ramirez, B. S., <i>Asst. Chem.</i> | |

RHODE ISLAND.

Rhode Island State College and the Agricultural Experiment Station, Kingston.

*College faculty. †Station staff. ‡Extension staff.

- *Howard Edwards, M. A., LL. D., *President.*
 *G. E. Adams, M. Agr., *Dean of Agr. Dept.*
 *†B. L. Hartwell, Ph. D., *Dir. of Sta.*
 †A. E. Stene, M. S., *Dir. Ext. Service. (State Ent.)*
 R. L. Wales, B. S., *Dean of Engin. Dept.*

- Agronomy:** †Dean Adams, *Prof. Agron.*
 Director Hartwell, *Sta. Agron.*
 *G. H. Baldwin, B. S., *Prof. Teacher Training in Agr.*
 †F. K. Crandall, B. S., *Asst. in Field Expts.*
 †S. C. Damon, B. S., *Asst. in Field Expts.*
 *L. A. Keegan, B. S., *Instr. Agron.*

- Animal Industry:** *J. E. Ladd, M. S., *Prof. An. Husb.*
 *C. E. Brett, B. S., *Instr. Poultry Husb.*
 *Howland Burdick, B. S., *Asst. Prct. Laying and Farm Mach., Mgr. of Farm.*
 *†H. G. May, Ph. D., *Prof. Bact.; An. Brdg. and Path.*

Animal Industry—Continued

- †W. H. Scott, B. S., *Asst. in An. Brdg. and Path.*
 †R. P. Tittsler, B. S., *Asst. in An. Brdg. and Path.*

Botany: *H. W. Browning, Ph. D., *Prof. Bot.*

- †F. T. McLean, Ph. D., *Plant Physiol.*
 *Marian E. Deats, A. M., *Instr. Bot.*

Chemistry: Director Hartwell, *Prof. Agr. Chem.*

- †P. S. Burgess, Ph. D., *Chem.*
 †W. L. Adams, B. S., *Asst. Chem.*
 *J. W. Ince, M. A., *Prof. Chem.*
 *H. L. Jackson, M. S., *Prof. Indus. Chem.*
 †R. L. Jones, B. S., *Asst. Chem.*
 *F. W. Keaney, A. B., *Instr. Chem.*
 †J. B. Smith, B. S., *Assoc. Chem.*

Extension (Admin.):¹ Director Stene in charge, and County Agt. Leader.

- †Mrs. E. Hope Minor, B. S., *State Home Dem. Leader.*

Extension (Admin.)—Continued

- †L. F. Kinney, Jr., M. S., *State Club Leader.*

Home Economics: *Alice L. Edwards, A. M., *Prof. Home Econ.*

- *Winifred Hazen, B. S., *Instr. Home Econ.*
 *Mrs. Lillian L. Peppard, M. S., *Prof. Dom. Art.*

*Clara M. Taylor, B. S., *Instr. Home Econ.*

*Grace E. Whaley, B. S., *Prof. Teacher Training in Home Econ.*

Horticulture: *H. V. Marsh, B. S., *Instr. Hort.*

*C. E. Wildon, B. S., *Instr. Hort.*

Physics: *C. L. Coggins, B. S., *Asst. Prof. Phys.***Zoology:** *John Barlow, M. A., *Prof. Zool.*

*Frederick Bauer, M. S., *Instr. Zool.*

Miscellaneous:

- †H. Alida Birch, *Libr.*
 †Nathaniel Helme, *Met.*

SOUTH CAROLINA.

Clemson Agricultural College and the Agricultural Experiment Station, *Clemson College* (freight and express offices, Calhoun).

*College faculty. †Station staff. ‡Extension staff.

_____, *President.*

*†H. W. Barre, M. A., *Dir. of Sta.*

†W. W. Long, M. S., LL. D., *Dir. of Ext. Service.*

*F. H. H. Calhoun, Ph. D., *Dir. of Resident Teaching.*

S. B. Earle, A. M., M. E., *Dir. of Engin. Dept.*

Agronomy: *†C. P. Blackwell, M. S., *Prof. Agron.; Agron.*

- †T. S. Bule, B. S., *Assoc. Agron.*
 †J. L. Carbery, *Agron. (P. O., Spartanburg).*
 *G. H. Collings, M. S., *Asst. Prof. Agron.*
 †R. W. Hamilton, B. S., *Legumes Specialist.*
 †S. L. Jeffords, M. S., *Forage Crops Specialist (P. O., Spartanburg).*
 *J. T. McAlister, B. S., *Asst. Prof. Agron. and Farm Mach.*
 *F. H. Robinson, M. S., *Asst. Prof. Agron. and Soils.*
 †W. B. Rogers, B. S., *Asst. Agron.*
 *D. G. Sturkie, M. S., *Asst. Prof. Agron.*

Animal Industry: *†L. V. Starkey, M. S., *Prof. An. Husb.; An. Husb.*

- *†J. P. La Master, B. S., *Prof. Dairying; Dairy-man.*
 †C. G. Cushman, B. S., *Agt. in Dairying (P. O., Spartanburg).*
 †A. L. DuRant, M. S., *Livestock Specialist (P. O., Florence).*
 †E. G. Godbey, B. S., *Assoc. An. Husb.*
 *B. E. Goodale, B. S., *Assoc. Prof. Dairying.*
 †W. J. Keegan, B. S., *Dairy Husb. (P. O., Florence).*
 †L. H. McKay, B. S., *Livestock Specialist (P. O., Aiken).*
 *C. L. Morgan, B. S., *Assoc. Prof. An. Husb.*
 †F. C. Shelton, *Agt. in Dairying (P. O. Aiken).*

Botany and Bacteriology: Director Barre in charge. (*State Path.*).

- *†W. B. Aull, B. S., *Assoc. Prof. and Assoc. Bact.*
 †C. A. Ludwig, Ph. D., *Assoc. Bot. and Plant Path.*

Botany and Bacteriology—Continued.

†W. D. Moore, Ph. D., *Ext. Plant Path.*

*D. B. Rosenkrans, M. A., *Assoc. Prof. Bot.*

Chemistry: *†R. N. Brackett, Ph. D., *Dir. Chem. Dept.; Chem. (State Chem.).*

*Benjamin Freeman, B. S., *Asst. in Chem.*

*†W. L. Lippincott, B. Ch., *Prof. and Assoc. Chem.*

*J. H. Mitchell, M. S., *Assoc. Prof. Chem.*

Economics: *†W. H. Mills, A. B., D. D., *Prof. Rural Sociol. and Field Agt. in Agr. Finance.*

†F. L. Harkey, A. B., *Chief of Marketing Div. (P. O., Spartanburg).*

†L. H. Lewis, B. S., *Agt. in Marketing (P. O., Florence).*

†C. A. Owens, B. S., *Specialist in Packing and Grading (P. O., Aiken).*

†D. D. Whitcomb, *Agt. in Marketing (P. O., Aiken).*

Education (Agr.): *W. G. Crandall, B. S., *Prof. Agr. Ed.*

*Verd Peterson, A. B., *Consult. Prof. Agr. Ed. (P. O., Columbia).*

*T. K. Sisk, A. M., *Assoc. Prof. Agr. Ed.*

*W. H. Washington, M. S., *Assoc. Prof. Agr. Ed.*

*G. E. Wilson, M. S., *Asst. Prof. Agr. Ed.*

Extension (Admin.):¹ Director Long in charge, and State Agt.

†D. W. Watkins, B. S., *Asst. Dir.*

†Lionie I. Landrum, B. S., *State Home Dem. Agt. (P. O., Rock Hill).*

†Mrs. Harriett F. Johnson, A. B., *State Club Agt. (P. O., Rock Hill).*

†B. O. Williams, B. S., *State Club Agt.*

¹ For subject-matter workers see the respective division, i. e., agronomy, animal industry, etc.

Extension (Admin.)—Continued.

- †Harriette B. Layton, *Asst. State Home Dem. Agt. (P. O., Rock Hill).*
 †I. D. Lewis, *Asst. State Club Agt.*
Horticulture: *†C. C. Newman, B. S., *Prof. Hort.; Hort.*
 *C. P. Hoffmann, B. S., *Assoc. Prof. Hort.*
 †A. M. Musser, M. S., *Assoc. Hort.*
 †E. H. Rawl, M. S., *Asst. Hort.*
 †A. E. Schilleter, B. S., *Asst. Hort.*

Veterinary Science: *†R. O. Feeley, D. V. S., *Prof. Vet. Sci.; Consult. Vet.*

- Zoology and Entomology:** *†A. F. Conradi, M. S., *Prof. Zool.; Ent. (State Ent.).*
 †J. A. Berly, B. S., *Asst. State Ent.*
 *†C. O. Eddy, M. S., *Assoc. Prof. and Assoc. Ent.*
 †C. B. Nickels, M. S., *Research Asst. Ent.*
 †E. S. Prevost, *Beekeeping Specialist.*

Zoology and Entomology—Continued.

- *W. D. Reed, B. S., *Instr. Zool. and Ent.*
Miscellaneous:
 †G. H. Aull, B. S., *Asst. to Dir. of Sta.*
 †A. B. Bryan, B. S., B. Litt., *Agr. Editor.*
 *†S. W. Evans, *Treas.*
 †Burns Gillison, *Foreman of Expt. Farm.*
 †J. L. Merritt, *Asst. Editor.*
 †C. S. Patrick, B. S., *Supt. of Farms.*
 †Mrs. Helen S. Torrence, *Agr. Libr.*

Substations:

- Boll Weevil Control Sta., P. O., Florence—
 ———, *in charge.*
 Coast Sta., P. O., Summerville—J. A. Riley, M. S., *Supt.*
 Pee Dee Sta., P. O., Florence.—
 R. E. Currin, *Supt.*
 E. D. Kyzer, B. S., *Research Asst.*

Colored Normal, Industrial, Agricultural, and Mechanical College of South Carolina, Orangeburg.

*Agricultural faculty. †Extension staff.

- *†R. S. Wilkinson, Ph. D., *President. In Charge of Ext. Work.*
 *F. M. Staley, B. S., *Dir. Agr. Dept., Prof. Agr.*

- *Olive K. Benson, *Dir. Home Econ.*
 *Mae A. Black, L. I., *Instr. Cooking and Di-
 etetics.*
 †Dora E. Boston, *Supvr. Home Dem. Work.*
 *W. H. Buchanan, B. S., *Prof. Hort.*
 *†H. E. Daniels, B. S., *Asst. Dir. Ext. Work.*
 *C. Clara Davis, A. M., *Instr. Sewing.*
 †Ida P. Davis, R. N., *Instr. Rural Nursing and
 Sanitation.*
 *B. R. Dent, *Teacher-Training Home Econ.*
 *A. H. Gordon, A. B., *Instr. Agr. Ed.*

- *C. D. Haynes, A. B., *Instr. Voc. Agr. and
 Gardening.*
 *M. Johnakin, *Teacher-Training Agr.*
 *T. J. Lyles, B. S., *Prof. Dairying.*
 *Marion R. Mickey, L. I., *Instr. Dressmaking.*
 *Anna L. Overstreet, L. I., *Instr. Dom. Econ.*
 *†S. M. Pinckney, B. S., *Prof. An. Indus.*
 *L. C. Potter, B. S., *Instr. Agr. Chem. and
 Dairying.*
 *J. I. Washington, *Instr. Farm Accounting.*
 *J. T. Williamson, B. S., *Prof. Agr. Pedag.*

SOUTH DAKOTA.**South Dakota State College of Agriculture and Mechanic Arts and the Agricultural Experiment Station, Brookings.**

*College faculty. †Station staff. ‡Extension staff.

- *C. W. Pugsley, B. S., D. Agr., *President.*
 *C. Larsen, M. S., *Dean of Agr.*
 *†J. W. Wilson, M. S., LL. D., *Dir. of Sta.*
 †W. F. Kumlien, M. S., *Dir. of Ext. Div.*
 *†R. A. Larson, *Secy.*
 H. B. Mathews, M. S., *Chair. of Engin. Staff.*

Agronomy: *†A. N. Hume, Ph. D., *Prof. Agron.; Agron. and Supt. of Substns. Dir. State Soil Survey.*

- *†J. G. Hutton, M. S., *Assoc. Prof. and Assoc. Agron. Asst. Dir. State Soil Survey.*
 *Ray Bulger, B. S., *Asst. in Agron.*
 *†A. L. Bushey, M. S., *Asst. Prof. and Asst. Agron.*
 *†Matthew Fowlds, B. S., *Instr. Agron.; Asst. in Crops.*
 *†E. W. Hardies, B. S., *Asst. Prof. and Asst. Agron.*
 †R. E. Johnston, B. S., *Agron.*
 *G. A. Larson, B. S., *Asst. in Agron.*
 *J. A. Machlis, B. S., *Asst. in Agron. and Soil Survey.*
 †G. H. Valentine, B. S., *Asst. Agron.*

Animal Husbandry: Director Wilson *in charge.*

- *G. L. Stevenson, B. S., *Prof. Poultry Husb.*
 *C. D. Grinnells, D. V. M., B. S., *Assoc. Prof. An. Husb.*
 †Gerald Heebink, M. S., *Asst. Livestock Special-
 ist.*
 *F. H. Helmreich, B. S., *Asst. Prof. An. Husb.*
 *†A. H. Kuhlman, M. S., *Assoc. Prof. and Assoc. An. Husb.*
 *Enoch Peterson, *Instr. Poultry Husb.*
 †Clara M. Sutter, *Poultry Specialist.*
 †T. R. H. Wright, B. S., *Livestock Specialist.*
Botany and Plant Pathology: *A. T. Evans, Ph. D., *Prof. Bot., Plant Path.*
 *E. J. Petry, M. S., *Consult. Bot.*
Chemistry: *†B. A. Dunbar, A. M., *Prof. Chem.; Chem.*

Chemistry—Continued.

- *E. R. Bennewies, M. S., *Assoc. Prof. Chem.*
 *G. W. Botteron, M. S., *Asst. Prof. Chem.*
 *D. C. Farley, B. S., *Instr. Chem.*
 *C. F. Wells, M. S., *Instr. and Asst. Chem.*

Dairy Husbandry: *†T. M. Olson, M. S., *Assoc. Prof. and Actg. Head of Dept.*

- *Lynn Copeland, M. S., *Asst. Prof. Dairy Husb.*
 *R. M. Gilcreast, B. S., *Instr. Dairy Husb.*
 †H. M. Jones, B. S., *Dairy Specialist.*
 *C. C. Totman, B. S., *Instr. in charge Dairy Mfrs.*

Economics (Agr.): *†M. R. Benedict, B. S., *Prof. Farm Econ.*

- †H. D. McCullough, B. S., *Farm Econ.*
 *R. E. Post, M. S., *Asst. Prof. Farm Econ.*
 *V. R. Wertz, M. S., *Asst. Prof. Farm Econ.*
 †C. G. Worsham, M. S., *Assoc. in Farm Econ.*

Education (Agr.): *C. R. Wiseman, M. S., *Asst. Prof. in charge.***Engineering (Agr.):** *J. A. Bonnell, *Asst. Prof. Farm Mach.*

- *E. E. Hartnett, M. A., *Asst. Prof. Indus. Art.*
 †R. L. Patty, B. S., *Agr. Engin. Specialist.*

Extension (Admin.): † Director Kumlien in charge.

- †E. W. Hall, B. S., *County Agt. Leader.*
 †P. J. Scarbro, A. B., *in charge Ext. Methods for Boys and Girls.*

Home Economics: *Edith Pierson, M. S., *Prof. Home Econ.*

- *Ada B. Caldwell, *Prof. Indus. Arts.*
 †Mary A. Dolve, B. S., *Specialist in Foods.*
 †May Keithline, *Specialist in Clothing and Boys' and Girls' Club Work.*

Home Economics—Continued.

- *Louise L. Leaton, B. S., *Asst. Prof. Home Econ.*
 †Azalea Linfield, M. A., *Clothing Specialist.*
 *Laura J. McArthur, B. S., *Asst. Prof. Home Econ.*

- *Grace E. Wasson, Ph. B., *Instr. Home Econ.*
 †Susan Z. Wilder, M. S., *Specialist in Foods.*

Horticulture: *†N. E. Hansen, Sc. D., *Prof. Hort. and For.; Hort. and Vice Dir. of Sta.*

- *P. L. Keene, M. S., *Asst. Prof. Hort.*

Journalism: *†P. W. Kieser, *Prof. Journalism; Agr. Editor.***Physics:** Prof. Mathews in charge.

- *H. H. Hoy, M. S., *Assoc. Prof. Phys.*

Veterinary Medicine: *†C. C. Lipp, D. V. M., *Prof. Vet. Med.; Dir. An. Health Lab.*

- *†K. T. Redfield, D. V. M., *Instr. Bact.; Asst. Vet.*

- *J. B. Taylor, V. M. D., *Instr. Vet. Sci. and Bact.*

- †G. S. Weaver, V. S., *Vet. Specialist.*

Zoology and Entomology: *†H. C. Severin, M. A., *Prof. Zool. and Ent.; Ent. (State Ent.)*

- †A. L. Ford, M. S., *Ent. Specialist.*

- *†G. I. Gilbertson, M. S., *Asst. Prof. Zool.; Asst. Ent.*

- *R. M. Gilcreast, B. S., *Instr. Apiculture.*

- *E. C. O'Roke, M. A., *Asst. Prof. Zool.*

Substations:

- Cottonwood—H. M. Sanderson, *Foreman.*

- Eureka—Joseph Hoffman, *Foreman.*

- Highmore—S. W. Sussex, *Foreman.*

- Vivian—Frank Hussey, *Foreman.*

TENNESSEE.**College of Agriculture and the Agricultural Experiment Station of the University of Tennessee, Knoxville.**

* College faculty. † Station staff. ‡ Extension staff.

*H. A. Morgan, B. S., LL. D., *President of University.*

*C. A. Willson, M. S., M. Agr., *Dean Coll. of Agr.*

†C. A. Mooers, B. S., *Dir. of Sta.*

†C. A. Keffer, M. H., *Dir. Div. of Agr. Ext.*

C. E. Ferris, M. E., *Dean Coll. of Engin.*

Agronomy: Director Mooers in charge.

†L. W. Blair, *Asst. in Coop. Expts. (P. O., Allardt).*

†J. E. Converse, *Asst. in Coop. Expts. (P. O., Crossville).*

*O. W. Dynes, M. S., *Assoc. Prof. Agron.*

†J. G. Faulkner, *Asst. in Plat Work.*

*R. B. Lowry, M. S., *Assoc. Prof. Agron.*

†J. C. McAmis, B. S., *Agron. Specialist.*

†L. S. Mayer, *Asst. Agron. in charge Corn Invest. (Detailed by U. S. D. A.).*

†R. H. Milton, B. S., *Asst. Agron. Specialist (P. O., Nashville).*

†H. P. Ogden, B. S., *Asst. in Coop. Expts. (P. O., Murfreesboro).*

†S. M. Spangler, *Asst. in Plat Work.*

Animal Industry: *†Moses Jacob, V. M. D., *Prof. An. Husb.; An. Husb.*

*C. E. Wylie, M. A., *Prof. Dairying.*

*I. A. Buckels, B. S., *Instr. Dairy Prod.*

*H. R. Duncan, B. S., *Asst. Prof. An. Husb.*

Animal Industry—Continued.

†L. S. Edwards, B. S., *Creamery Mfg. (P. O., Lebanon: Detailed by U. S. D. A.).*

†C. C. Flanery, M. S., *Asst. in An. Husb.*

*T. B. Harrison, B. S., *Instr. Dairy Mfrs.*

†C. A. Hutton, B. S., *Dairy Husb. Specialist.*

†J. H. McLeod, B. S., *Asst. in An. Husb.*

*L. Z. Morris, B. S., *Voc. Instr. An. Hu. b.*

†L. A. Richardson, B. S., *An. Husb. Specialist.*

*C. W. Robinson, B. S., *Voc. Instr. An. Husb.*

†G. N. Tobey, *Cheese Specialist.*

†Mrs. Kate M. Wells, B. S., *Poultry Husb. Specialist.*

Bacteriology: *P. W. Allen, Ph. D., *Prof. Bact.*

*M. A. Jacobson, M. S., *Asst. Prof. Bact.*

Botany: *L. R. Hesler, Ph. D., *Prof. Bot.*

†S. H. Essary, M. S., *Bot.*

†C. D. Sherbakoff, Ph. D., *Plant Path.*

*H. M. Jennison, Ph. D., *Assoc. Prof. Bot.*

†J. A. McClintock, M. S., *Assoc. Prof. Plant Path.*

†Annie E. Neubert, *Asst. Plant Path.*

† For subject-matter workers see the respective division, i. e., agronomy, animal husbandry, etc.

Chemistry: *C. E. Wait, C. E., M. E., Ph. D.,
Prof. Gen. and Anal. Chem.
†W. H. MacIntire, Ph. D., *Soil Chem.*
*C. A. Buehler, B. Ch. E., Ph. D., *Asst. Prof. Chem.*
†T. D. Harden, B. S., *Asst. Chem.*
*C. O. Hill, Ph. C., M. S., *Prof. Org. and Agr. Chem.*
*J. H. Robertson, Ph. D., *Assoc. Prof. Chem.*
†W. M. Shaw, M. S., *Asst. Chem.*
†J. B. Young, B. A., *Asst. Chem.*
Economics (Agr.): *†C. E. Allred, M. S., *Prof. Agr. Econ.; Agr. Economist.*
†A. L. Jordan, B. S., *Marketing Specialist.*
†Elizabeth Moreland, B. A., *Community Service Specialist.*
†R. J. Morgan, B. S., *Organ. Specialist.*
Education (Agr.): *N. E. Fitzgerald, B. Pd.,
B. S., *Prof. Agr. Ed.*
*J. P. Buck, B. S., *Assoc. Prof. Agr. Ed.*
*H. C. Graybeal, M. S., *Asst. Prof. Agr. Ed.*
Engineering (Agr.): †H. B. Bliss, B. S., *Farm Mach. Specialist.*
*W. C. Krueger, B. S., *Instr. Rural Engin.*
Extension (Admin.): † Director Keffer in charge.
†C. E. Brehm, B. S., *Asst. Dir.*
†G. L. Herrington, B. S., *State Club Agt.*
†Margaret A. Ambrose, *Asst. Dir. Home Dem. Work.*
Geology: *C. H. Gordon, Ph. D., *Prof. Geol.*
Home Economics: *Nellie Crooks, B. S., *Dir. of Dept.*
*Esther Bracken, M. S., *Asst. Prof. Home Econ.*
*Mary Dahnke, B. S., *Instr. Home Econ.*
*Amanda Ebersole, B. S., *Asst. Prof. Home Econ.*

Home Economies—Continued.
†Maude L. Guthrie, M. A., *Home Econ. Specialist.*
*Ruby E. Hitch, B. A., *Asst. Prof. Home Econ.*
†Lillian Keller, B. S., *Asst. Specialist in Home Econ.*
*Katherine Slightam, B. S., *Asst. Prof. Home Econ.*
†Mrs. Lena A. Warner, R. N., *Health and Sanitation Specialist.*
Horticulture: *N. D. Peacock, M. S., *Assoc. Prof. in charge Hort. Work.*
†Otha Ogle, *Foreman of Fruit Farm.*
Veterinary Science: *†Prof. Jacob in charge.
Zoology and Entomology: *E. B. Powers, Ph. D., *Prof. Zool.*
*G. M. Bentley, M. A., *Assoc. Prof. Ent. (State Ent. and Plant Path.).*
*W. E. Bullington, M. S., *Instr. Zool.*
†Simon Marcovitch, M. S., *Asst. Ent.*
*Hamilton Steele, *Voc. Instr. Beekeeping.*

Miscellaneous:
†F. H. Broome, *Secy., Photog.*
*W. A. Campbell, *Farm Supt.*
†Florence D. McTeer, *Ext. Secy.*
†A. J. Sims, *Ext. Editor.*
*†Lucile Warnock, A. B., B. L. S., *Asst. Agr. Libr.*
Substations:
Middle Tenn. Expt. Sta., P. O., Columbia—
L. R. Neel, B. S., *Supt.*
Tobacco Expt. Sta., P. O., Clarksville—H. W. Jones, *Supt.*
West Tenn. Expt. Sta., P. O., Jackson—
S. A. Robert, B. S., *Supt.*
R. L. Long, *Asst. in Plat Work.*

Tennessee Agricultural and Industrial State Normal School, Nashville.

*Agricultural faculty.

*W. J. Hale, *President.*

*Mrs. Martha M. Brown, *Dir. Home Econ.*
*R. B. J. Campbell, *Asst. in Sci.*
*D. H. Coleman, *Truck Gard. and Applied Agr.*
*Janie Elliott, *Applied Dom. Sci.*
*Ella Gordon, *Nurse Training.*
*C. H. Harper, M. A., *Teacher Training in Agr.*
*Mrs. W. H. Hodgkins, *Poultry Raising.*
*Mary B. Jackson, B. S., *Dom. Sci.*

*J. D. Jarmon, D. V. M., *Agr.*
*Mrs. A. T. Johnson, *Handicrafts.*
*J. S. Julian, *Sci.*
*Agnes L. Kelley, *Tailoring and Designing.*
*Mrs. Octavia Robinson, *Dom. Art.*
*Frances Thompson, *Manual Art.*
*Mary L. Wilson, *Household Mgt.*

TEXAS.

Agricultural and Mechanical College of Texas and the Agricultural Experiment Station, College Station.

*College faculty. †Station staff. ‡Extension staff.

*W. B. Bizzell, Ph. D., D. C. L., LL. D., *President.*
†B. Youngblood, Ph. D., *Dir. of Sta.*
†T. O. Walton, *Dir. Ext. Service.*
*Charles Puryear, M. A., C. E., LL. D., *Dean of Coll.*
*E. J. Kyle, M. S., *Dean School of Agr.*
F. C. Bolton, B. S., *Dean School of Engin.*

Agronomy: †E. B. Reynolds, M. S., *Chief of Div.* **Agronomy—Continued.**

†A. B. Conner, M. S., *Vice Dir. of Sta. (Grain Sorghum Research).*
†A. H. Leidigh, M. S., *Asst. Dir. of Sta. (Small Grain Research).*
*J. O. Morgan, Ph. D., *Head Prof. Agron.*
†G. N. Stroman, Ph. D., *Cotton Brdg.*
*W. H. Corpening, B. S., *Instr. Agron.*
*H. V. Geib, B. S., *Asst. Prof. Agron.*

† For subject-matter workers see the respective division, i. e., agronomy, animal industry, etc.

Agronomy—Continued.

- †D. T. Killough, B. S., *Supt. Main Sta. Farm.*
 *E. O. Pollock, A. M., *Asst. Prof. Agron.*
 *J. H. Stallings, M. S., *Assoc. Prof. Agron.*

Animal Industry: †J. M. Jones, A. M., *Chief of Div. (Sheep and Goat Invest.).*

- *D. W. Williams, M. S., *Head Prof. An. Husb.*
 *G. P. Grout, M. S., *Head Prof. Dairy Husb.*
 *D. H. Reid, M. S., *Head Prof. Poultry Husb.*
 †G. W. Barnes, B. S., *Beef Cattle Specialist.*
 *D. S. Buchanan, B. S., *Asst. Prof. An. Husb.*
 †A. Clutter, jr., B. S., *Assoc. Prof. Dairy Husb.*

- *A. L. Darnell, M. A., *Assoc. Prof. Dairy Husb.*
 †E. O. Edson, *Poultry Husb.*
 *A. H. Groth, M. S., *Instr. An. Husb.*
 †J. J. Hunt, *Wool Grader.*
 *D. F. Irving, B. S., *Asst. Prof. Poultry Husb.*
 †J. L. Lush, Ph. D., *An. Husb. (Genetics).*
 †Myrtle Murray, *Poultry Specialist.*
 *E. M. Regenbrecht, B. S., *Assoc. Prof. An. Husb.*

- †R. M. Sherwood, B. S., *Poultry Husb.*
 *W. L. Stangel, A. M., *Prof. An. Husb.*
 †J. L. Thomas, *Dairy Specialist.*
 †A. L. Ward, *Swine Husb.*
 †G. R. Warren, B. S., *Swine Husb.*
 *H. T. Wilson, M. S., *Asst. Prof. An. Husb.*

Biology: *O. M. Ball, Ph. D., *Head Prof.*

- *Howard Burt, A. B., *Asst. Prof. Biol.*
 *P. F. English, B. S., *Asst. Prof. Biol.*
 *E. H. Harper, Ph. D., *Assoc. Prof. Biol.*
 *D. J. Pratt, A. M., *Assoc. Prof. Biol.*
 *G. W. Stuppy, M. S., *Asst. Prof. Biol.*

Botany: †Helge Ness, M. S., *Chief of Div.***Chemistry and Chemical Engineering:** †G. S. Fraps, Ph. D., *Chief Div. of Chem. (State Chem.).*

- *C. C. Hedges, Ph. D., *Head Prof. Chem. and Chem. Engin.*
 †S. E. Asbury, M. S., *Asst. Chem.*
 *George Bauer, B. S., *Instr. Chem.*
 *F. F. Bishop, B. S., *Instr. Chem.*
 †J. K. Blum, B. S., *Asst. Chem.*
 *H. R. Brayton, M. S., *Prof. Chem.*
 *F. H. Fish, Ch. E., *Assoc. Prof. Chem.*
 †Velma Graham, *Chem. Lab. Asst.*
 *E. L. Harter, A. B., *Instr. Chem.*
 *F. H. Hood, A. B., Ph. G., *Instr. Chem.*
 *B. C. Jones, A. B., *Instr. Chem.*
 *L. G. Jones, M. S., *Asst. Prof. Chem.*
 *L. A. Koenig, B. A., *Asst. Prof. Chem.*
 †A. G. Peterson, B. S., *Asst. Chem.*
 *A. J. Spieth, A. B., *Instr. Chem.*
 †J. E. Teague, B. S., *Asst. Chem.*
 *C. R. Voges, B. S., *Instr. Chem.*
 †W. H. Walker, *Asst. Chem.*

Economics (Agr.): †L. P. Gabbard, M. S., *Chief Div. Farm and Ranch Econ. (Coop. U. S. D. A.).*

- *F. A. Buechel, Ph. D., *Head Prof. Agr. Econ., Head Course in Agr. Admin.*
 *W. E. Garnett, Ph. D., *Head Prof. Rural Sociol.*
 *J. C. Butler, B. A., *Instr. Agr. Econ.*
 †V. L. Cory, M. S., *Grazing Research Bot., Farm and Ranch Econ.*

Economics (Agr.)—Continued.

- †M. M. Daugherty, *Farm Mgt. Specialist.*
 †R. R. Lancaster, *Rural Organizer.*
 †W. B. Lanham, A. M., *Rural Economist.*
 *V. P. Lee, Ph. D., *Prof. Agr. Econ.*
 *T. W. Leland, M. A., *Assoc. Prof. Agr. Econ.*
 *C. M. Purves, M. A., *Instr. Agr. Econ.*
 †H. E. Rea, B. S., *Asst. in Farm and Ranch Econ.*

*R. C. White, M. A., *Assoc. Prof. Rural Sociol.*

Education (Agr.): *C. H. Winkler, Ph. D., *Dean School of Voc. Teaching and Head Prof. Agr. Ed.*

- *J. H. Kraft, B. S., *Prof. Agr. Ed.*
 *W. L. Hughes, M. S., *Prof. Rural Ed.*

Engineering (Agr.): *Daniels Scoates, B. S. (C. E., A. E.), *Head Prof.*

- †M. R. Bentley, *Agr. Engin.*
 *F. R. Jones, B. S., *Asst. Prof. Agr. Engin.*
 *H. P. Smith, B. S., *Assoc. Prof. Agr. Engin.*
 *S. D. Snyder, B. S., *Assoc. Prof. Agr. Engin.*

Entomology: †M. C. Tanquary,¹ Ph. D., *Chief of Div. (State Ent.).*

- *S. W. Bilsing, M. A., *Head Prof. Ent.*
 *A. H. Alex, B. S., *Queen Breeder, State Apicultural Research Lab., P. O., San Antonio.*
 *R. K. Fletcher, M. A., *Assoc. Prof. Ent.*
 †W. R. Jordan, B. S., *Apiary Insp.*
 *V. A. Little, B. A., *Asst. Prof. Ent.*
 †H. J. Morris, *Apiary Insp.*
 †H. B. Parks, B. S., *Apiculturist in charge State Apicultural Research Lab., P. O., San Antonio.*

†H. J. Reinhard, B. S., *Ent.*

†R. R. Reppert, *Ent.*

*R. G. Richmond, B. S., *Instr. Ent.*

†C. S. Rude, B. S., *Ent.*

†W. O. Victory, jr., *Apiary Insp.*

Extension (Admin.): †Director Walton in charge.

- †H. H. Williamson, *State Agt.*
 †Helen Higgins, *State Home Dem. Agt.*
 †S. C. Evans, *State Boys' Club Agt.*
 †Mrs. Edith M. Andrews, *Home Econ. Specialist.*

†Mrs. Dora R. Barnes, *Clothing Specialist.*

†Mrs. Maggie W. Barry, *Special Agt.*

†Mrs. Bernice Claytor, *Home Econ. Specialist.*

†Mildred F. Horton, *Asst. State Home Dem. Agt.*

†R. W. Persons, *Asst. State Agt., Club Work.*

†A. K. Short, *Ext. Methods.*

Feed Control Service: †F. D. Fuller, M. S., *Chief.*

†D. W. Carlton, B. S., *Insp.*

†J. J. Kelly, *Insp.*

†S. D. Pearce, *Secy.*

†J. D. Prewit, B. S., *Insp.*

†J. H. Rogers, *Insp.*

†W. H. Wood, *Insp.*

Forestry: *E. O. Siecke, B. S., *Head Prof. (State For.).*

Genetics: *E. P. Humbert, Ph. D., *Head Prof.*

*W. R. Horlacher, B. S., *Assoc. Prof. Genetics.*

Geology: *E. O. Randolph, M. S., D. Litt., *Head Prof.*

*F. A. Burt, B. S., *Assoc. Prof. Geol.*

Horticulture: †A. T. Potts, M. S., *Chief of Div.*

*E. J. Kyle, M. S., *Head Prof. Hort.*

¹ Resigns May 1, 1924. Succeeded by F. L. Thomas, of Alabama.

² For subject-matter workers see the respective division, i. e., agronomy, animal industry, etc.

Horticulture—Continued.

- *G. W. Adriance, M. S., *Asst. Prof. Hort.*
 *C. A. Boyer, B. S., *Instr. Hort.*
 *F. W. Hensel, M. S., *Prof. Hort.*
 †E. A. Miller, B. S., *Veg. Specialist.*
 †A. P. Swallow, *Hort.*
 *C. B. Wiggins, M. S., *Instr. Hort.*

Plant Pathology and Physiology: †J. J. Taubenhaus, Ph. D., *Chief of Div.***Publications:** †A. D. Jackson, *Chief of Div.*
 †S. C. Hoyle, *Ext. Editor.***Soil Survey:** †W. T. Carter, jr., B. S., *Chief of Div. (Coop. U. S. D. A.).*

- †H. W. Hawker, *Soil Surveyor.*
 †Edward Templin, B. S., *Soil Surveyor.*

Veterinary Medicine: *†Mark Francis, D. V. M., *Dean School of Vet. Med.; Chief Div. of Vet. Sci.*

- †V. J. Brauner, D. V. M., *Vet.*
 †H. Schmidt, D. V. S., *Vet.*

Miscellaneous:

- †C. A. Felker, *Chief Clerk.*

Miscellaneous—Continued.

- †C. J. Gorzycki, *Tech. Asst. (Photog.).*
 †J. M. Schaedel, *Executive Asst.*
 †A. S. Ware, *Secy.*

Substations:

- Angleton (No. 3)—V. E. Hafner, B. S., *Supt.*
 Balmorhea (No. 9)—J. J. Bayles, B. S., *Supt.*
 Beaumont (No. 4)—A. H. Prince, B. S., *Supt.*
 Beeville (No. 1)————— *Supt.*
 Chillicothe (No. 12)—D. L. Jones, *Actg. Supt.*
 (Coop. U. S. D. A.).
 College Station (No. 10)—L. J. McCall, *Supt.*
 Denton (No. 6)—P. B. Dunkle, B. S., *Supt.*
 Lubbock (No. 8)—R. E. Karper, B. S., *Supt.*
 Mercedes (No. 15)—W. H. Friend, B. S., *Supt.*
 Nacogdoches (No. 11)—G. T. McNess, *Supt.*
 Sonora (No. 14)—
 E. M. Peters, B. S., *Supt.*
 D. H. Bennett, V. M. D., *Vet.*
 O. L. Carpenter, B. S., *Shepherd.*
 Spur (No. 7)—R. E. Dickson, B. S., *Supt.*
 Temple (No. 5)—A. B. Cron, B. S., *Supt.*
 Troup (No. 2)—W. S. Hotchkiss, *Supt.*

Prairie View State Normal and Industrial College, Prairie View.

*Agricultural faculty. †Extension work.

- *I. G. Osborne, B. S., M. D., *Principal.*
 *R. B. Atwood, *Dir. of Agr.*

- *J. M. Alexander, *Prof. Plant and Poultry Husb.*
 *M. B. Arrington, *Assoc. Prof. Dom. Sci.*
 *Diana S. Bent, *Assoc. Prof. Dom. Art.*
 *C. C. Carrington, *Prof. Hort.*
 *H. G. Dickerson, B. S., *Prof. Voc. Agr.*
 *Mrs. N. B. Dillon, *Asst. in Dom. Sci.*
 *E. B. Evans, D. V. M., *Prof. Vet. Sci.*
 *Henrietta Farrell, *Laundry Asst.*

- †Mrs. M. E. V. Hunter, *Home Econ. Ext.*
 *Mrs. A. E. Johnson, *Asst. in Dom. Art (Millinery).*
 *E. F. Martin, *Asst. in Dom. Art.*
 *Elizabeth C. May, B. S., *Dir. Home Econ.*
 *C. S. Ross, B. S., *Prof. An. Husb.*
 †C. H. Waller, B. S., *State Leader in Ext. Work.*
 *Gertrude Williams, *Libr.*
 *Weldon Williams, *Laundry Foreman.*

UTAH.**Agricultural College of Utah and the Agricultural Experiment Station, Logan.**

*College faculty. †Station staff. ‡Extension staff.

- *E. G. Peterson, Ph. D., *President.*
 *†G. R. Hill, jr., Ph. D., *Dean School of Agr.*
 *†William Peterson, B. S., *Dir. of Sta.*
 †R. J. Evans, Ph. D., *Dir. of Ext. Div.*
 *†R. B. West, B. S., C. E., *Dean Schools of Agr. Engin. and Mech. Arts, Dir. Agr. Engin. Expt. Sta.*

Agronomy: *†George Stewart, M. S., *Prof. Agron.; in charge Field Crops.*

- †D. S. Jennings, Ph. D., *in charge Soil Survey Work.*
 †J. C. Hogenson, M. S., *Ext. Agron.*
 *†D. W. Pittman, M. S., *Asst. Prof. Agron.; Assoc. Agron.*
 †M. D. Thomas, B. S., *Assoc. Agron.*

Animal Industry: *†W. E. Carroll, Ph. D., *Prof. An. Husb.; An. Husb.*

- *†G. B. Caine, A. M., *Prof. Dairy Husb.; Dairy Husb.*
 *††Byron Alder, B. S., *Asst. Prof. Poultry Husb.; Poultryman.*
 *†R. J. Bcraft, B. S., *Asst. Prof. in charge Range Mgt.*
 †J. T. Caine, III, M. S., *Livestock Specialist.*
 †B. R. Eldredge, B. S., *Dairy Specialist P. O., Salt Lake City.*

Animal Industry—Continued.

- *†Gustav Wilster, M. S., *Assoc. Prof. and Assoc. Dairy Husb.*

Bacteriology and Physiological Chemistry:

- *†J. E. Greaves, Ph. D., *Prof. Bact., Physiol. Chem.; Bact., Chem.*
 *†E. G. Carter, M. S., *Asst. Prof. Bact., Physiol.; Assoc. Bact.*

Botany and Plant Pathology: Dean Hill *in charge.*

- *††B. L. Richards, Ph. D., *Assoc. Prof. Bot., Plant Path.; Assoc. Bot.*
 *†L. F. Nuffer, M. S., *Instr. and Asst. Bot.*

Chemistry: *†R. L. Hill, Ph. D., *Prof. Chem.; Head Dept. of Human Nutr.*

- *†C. T. Hirst, M. S., *Asst. Prof. Chem.; Assoc. Chem.*
 *Sherwin Maeser, Ph. D., *Asst. Prof. Chem.*

Economics (Agr.): *†E. B. Brossard,¹ Ph. D., *Prof. Agr. Econ. and Farm Mgt.; Farm Mgt.*

*C. H. Merchant, M. S., *Actg. Prof. Agr. Econ. and Farm Mgt.*

*M. H. Harris, Ph. D., *Prof. Econ.*

*†W. L. Wanlass, Ph. D., *Marketing.*

Engineering (Agr.): *†O. W. Israelsen, M. S., *Prof. and in charge Irrig. and Drainage Engin.*

††L. M. Winsor, B. S., *Irrig. and Drainage Engin.*

Extension (Admin.):² Director Evans in charge.

†W. W. Owens, B. S., *County Agt. Leader.*

†Rena B. Maycock, *State Home Dem. Leader.*

*†J. H. Linford, D. Di., *Supt. Corresp. Studies Dept.*

*†F. R. Arnold, A. M., *in charge Community Service Bureau.*

Geology: Director Peterson in charge.

*D. S. Carder, B. S., *Instr. Geol.*

Home Economics: *Carrie C. Dozier, Ph. D., *Dean School of Home Econ., Prof. Foods and Dietetics.*

†Victoria B. Christensen, *Home Health and Nutr. Specialist.*

†Christine B. Clayton, B. S., *Foods Specialist.*

*Charlotte E. Dancy, *Asst. Prof. Nursing.*

*Johanna Moen, B. S., *Prof. Dom. Art.*

*Lavinia Richardson, B. S., *Instr. Dom. Art.*

†Rozina Skidmore, B. S., *Asst. Prof. Dom. Art.*

Horticulture: *†T. H. Abell, M. S., *Asst. Prof. in charge.*

*†Emil Hansen, *Instr. Hort. and Supt. Grounds and Greenhouses.*

Physics: *†F. L. West, Ph. D., *Prof. Phys.; Physicist.*

*†Willard Gardner, Ph. D., *Assoc. Prof. Phys.; Assoc. Physicist.*

*†N. E. Edlefsen, M. A., *Instr. Phys.; Asst. Physicist.*

Veterinary Science: *††H. J. Frederick, D. V. M., *Prof. Vet. Sci.; Vet.*

Zoology and Entomology: *††I. M. Hawley, Ph. D., *Prof. Zool., Ent.; Ent.*

*†H. J. Pack, B. S., *Asst. Prof. Zool., Ent.; Asst. Ent.*

*C. W. Rees, Ph. D., *Asst. Prof. Zool., Ent.*

Miscellaneous:

*†Peter Nelson, B. S., *Farm Foreman.*

*Blanche C. Pittman, A. B., *Libr.*

*Hattie Smith, *Asst. Libr.*

Substations:

Davis County Farm, P. O., *Farmington—A. L. Wilson, B. S., Supt.*

Nephi Substa., P. O., *Nephi—A. F. Bracken, B. S., Supt.*

Panguitch Farm, P. O., *Panguitch—J. R. Bateman, B. S., Supt.*

VERMONT.

College of Agriculture and the Agricultural Experiment Station of the University of Vermont and State Agricultural College, Burlington.

*College faculty. †Station staff. ††Extension staff.

*G. W. Bailey, B. A., LL. D., *President.*

*†J. L. Hills, Sc. D., *Dean Coll. of Agr., Dir. of Sta.*

†Thomas Bradlee, B. S., *Dir. Agr. Ext. Service.*

J. W. Votey, C. E., Sc. D., *Dean Coll. of Engin.*

Agronomy: Dean Hills in charge.

*†Ernest Van Alstine, Ph. D., *Assoc. Prof. Agron., Agron. Specialist.*

Animal Industry: *††H. B. Ellenberger, Ph. D., *Prof. An. and Dairy Husb.; An. and Dairy Husb.*

†S. G. Judd, B. S., *Dairy Specialist.*

*†H. A. D. Leggett, B. S., *Asst. Prof. Poultry Husb., Poultry Specialist.*

*†J. A. Newlander, M. S., *Instr. An. and Dairy Husb.; Asst. An. Husb.*

Botany: *†G. P. Burns, Ph. D., *Prof. Bot.; Bot.*

*†B. F. Lutman, Ph. D., *Prof. Plant Path.; Plant Path.*

*†E. J. Dole, Ph. D., *Instr. and Asst. Bot.*

*†Alexander Gershoy, B. S., *Instr. and Asst. Bot.*

*†A. H. Gilbert, M. S., *Asst. Prof. Bot.; Assoc. Plant Path.*

†Anna S. Lutman, B. S., *Seed Analyst.*

Chemistry: *A. B. Willmarth, M. S., *Asst. Prof. in charge Agr. Chem.*

†C. H. Jones, M. S., *Chem.*

†G. F. Anderson, *Asst. Chem.*

Economics (Agr.): †H. P. Young, B. S., *Farm Mgt. Dem.*

*†J. A. Hitchcock, B. S., *Instr. Farm Mgt., Asst. Farm Mgt. Dem.*

Education (Agr.): *†F. B. Jenks, B. S., *Prof. Agr. Ed., Asst. Dean Coll. of Agr.*

Engineering (Agr.): *†F. C. Fiske, B. S., *Instr. Farm Mech.*

Extension (Admin.):² Director Bradlee in charge, and County Agt. Leader.

†Lydia M. Potter, B. S., *State Home Dem. Leader.*

†E. L. Ingalls, A. B., *State Club Leader.*

†J. E. Carrigan, B. S., *Asst. County Agt. Leader.*

†Marjorie E. Luce, B. S., *Asst. State Club Leader.*

†C. H. Winslow, B. S., *Asst. to Dir.*

Home Economics: *Bertha M. Terrill, A. M., *Prof. Home Econ.*

*Florence Bailey, B. S., *Instr. Home Econ.*

*Alice E. Blundell, B. S., *Asst. Prof. Home Econ.*

*Sue C. Blundell, B. S., *Instr. Home Econ.*

*Hazel G. Field, B. S., *Instr. Home Econ.*

†Emma A. Fuller, B. S., *Home Econ. Specialist.*

*Jessie A. Winchell, B. S., *Asst. Prof. Home Econ.*

Horticulture: *††M. B. Cummings, Ph. D., *Prof. Hort.; Hort.*

†E. W. Jenkins, M. S., *Asst. Hort.*

Veterinary Science: *†F. A. Rich, V. S., M. D., *Prof. Vet. Sci.*

Zoology: *†H. F. Perkins, Ph. D., *Prof. Zool.*

Miscellaneous: *W. H. Crockett, *Editor.*

¹ On leave.

² For subject-matter workers see the respective division, i. e., agronomy, animal industry, etc.

VIRGINIA.

Virginia Agricultural and Mechanical College and Polytechnic Institute and the Agricultural Experiment Station, Blacksburg.

*College faculty. †Station staff. ‡Extension staff.

*J. A. Burruss, A. M., Ph. D., *President.**†H. L. Price, M. S., *Dean School of Agr.*†A. W. Drinkard, jr., Ph. D., *Dir. of Sta.*†J. R. Hutcheson, M. S., *Dir. of Ext. Div.*S. R. Pritchard, A. M., *Dean School of Engin.***Agronomy:** *†T. B. Hutcheson, M. S., *Prof. Agron.; Agron. and Supvr. of Substas.**†T. K. Wolfe, Ph. D., *Prof. Agron.; Agron.*†G. A. Jackson, B. S., *Asst. Agron.*†M. S. Kipps, B. S., *Asst. in Agron.*†G. W. Patteson, jr., B. S., *Agron. Specialist.**H. B. Redd, B. S., *Instr. Agron.***Animal Industry:** ††W. D. Saunders, *Dairy and An. Husb., Dairy Specialist.**R. E. Hunt, M. S., *Prof. An. Husb.**†C. W. Holdaway, M. S., *Prof. Dairy Husb.; Dairy Husb., Supt. of Creamery, Dairy, and Advanced Registry.**†A. F. Treakle, *Prof. Poultry Husb.**†F. A. Buchanan, B. S., *Assoc. Prof. Dairy Husb.**C. T. Cornman, *Asst. Prof. Poultry Husb.*†A. L. Dean, *Assoc. Poultry Husb.*†L. P. Emmerich, B. S., *Asst. Dairy Husb.*†G. C. Herring, B. S., *Asst. An. Husb.*†Bessie M. Hodsdon, *Asst. Poultry Specialist.*†C. R. Nobles, B. S., *Asst. An. Husb.**†T. S. Starnes, *Instr. Poultry Husb.*†Rachel F. Treakle, *Asst. in Poultry Husb.***Bacteriology and Plant Pathology:** *†F. D. Fromme, Ph. D., *Prof. Bact. and Plant Path.; Bact. and Plant Path.*†James Godkins, *Ext. Path.*†R. H. Hurt, B. S., *Asst. Plant Path. in charge Field Lab., P. O., Crozet.**†A. B. Massey, B. S., *Assoc. Prof. and Assoc. Bact. and Plant Path.*†F. J. Schneiderhan, M. S., *Asst. Plant Path.*†S. A. Wingard, M. S., *Assoc. Plant Path.***Chemistry:** *†W. B. Ellett, Ph. D., *Prof. Agr. Chem.; Chem.*†W. G. Harris, M. S., *Assoc. Chem.**†H. H. Hill, M. S., *Assoc. Chem.**†J. B. Lucas, M. S., *Assoc. Prof. Chem.***Economics (Agr.):** *†C. C. Taylor, M. S., *Assoc. Prof. Agr. Econ. and Specialist in Econ. and Marketing.*†J. J. Vernon, M. S., *Assoc. Agr. Economist.***Education (Agr.):** *D. S. Lancaster, M. S., *Prof. Agr. Ed.**W. B. Coggin, A. M., *Prof. Agr. Ed.**E. C. Magill, B. S., *Assoc. Prof. Agr. Ed.**W. S. Newman, M. S., *Assoc. Prof. Agr. Ed.***Engineering (Agr.):** *††C. E. Seitz, *Prof. Agr. Engin.; Agr. Engin.**W. T. Ackerman, B. S. A. E., *Instr. Agr. Engin.*

† State Crop Pest Commission Work.

‡ For subject-matter workers see the respective division, i. e., agronomy, animal industry, etc

Engineering (Agr.)—Continued.*†M. J. Markuson, B. S., *Instr. and Asst. Agr. Engin.*†J. A. Waller, jr., M. S., *Asst. Agr. Engin.***Entomology:** *†W. J. Schoene, M. S., *Prof. Econ. Ent.; Ent. (State Ent.).*†W. S. Hough, A. M., *Asst. Ent.¹*†L. A. Stearns, M. S., *Asst. Ent.¹*†G. W. Underhill, M. S., *Asst. Ent.¹*†C. R. Willey, B. S., *Asst. Ent.¹***Extension (Admin.):** ‡ Director Hutcheson in charge.†W. P. Moore, *Asst. Dir.*†Mrs. M. M. Davis, *State Home Dem. Agt.*†C. G. Burr, B. A., *State Agt. Boys' Club Work.*†Hallie L. Hughes, *State Agt. Girls' Club Work.*†C. A. Montgomery, B. S., *Asst. State Boys' Club Agt.***Home Economics:** †J. Eldona Oliver, B. S., *Clothing Specialist.*†Lula V. Walker, M. S., *Home Econ. Specialist.***Horticulture:** Dean Price in charge.*†T. C. Johnson, A. M., *Prof. Veg. Gard. (P. O., Norfolk).**†G. S. Ralston, M. S., *Prof. and Field Hort.*†Kent Apperson, *Asst. Hort.*†L. C. Beamer, *Asst. in Veg. Ext.**L. B. Dietrick, B. S., *Field Instr. Hort.*†R. C. Moore, B. S., *Asst. Hort.*†F. A. Motz, B. S., *Asst. Hort.**C. B. Price, *Instr. Hort.**†A. G. Smith, jr., B. S., *Asst. Prof. and Specialist in Veg. Gard.**†D. A. Tucker, B. S., *Instr. and Asst. Hort.***Veterinary Science:** *I. D. Wilson, D. V. M., M. S., *Prof. Vet. Sci.***Miscellaneous:***†Bettye Bell, *Asst. Libr. in charge Agr. Sec.**Frances M. Benson, *Acty. Libr.*†Mrs. A. P. Cunningham, *Asst. Libr.*†E. R. Price, *Editor.**†C. I. Wade, *Treas. (P. O., Christiansburg).***Substations:** T. B. Hutcheson, M. S., *Supervisor.*Appomattox—B. G. Anderson, B. S., *Supt.*Bowling Green—W. W. Green, *Supt. and Supr. of Tobacco Invest. (Coop. U. S. D. A.).*Charlotte Court House—H. C. Marshall, *Supt.*Chatham—T. L. Copley, B. S., *Supt.*Fishersville—P. C. Manley, B. S., *Supt.*Holland—E. T. Batten, B. S., *Supt.*Lightfoot—R. P. Cocke, *Supt.*Martinsville—O. P. Strawn, *Supt.*

Virginia Truck Experiment Station, Norfolk.

†Station staff.

†T. C. Johnson, A. M., *Director. Hort.*†R. J. Davis, A. B., *Assoc. Plant Path.*†G. R. Gardner, *Hort. Foreman.*†M. M. Parker, B. S., *Asst. Hort.*†G. R. Parrish, *Treas.*†D. M. Scott, *Supt. Eastern Shore Expt. Farm, P. O., Olney.*†Herbert Spencer, Ph. D., *Assoc. Ent. in charge Insect Invest.*†H. H. Zimmerley, B. S., *Hort.*

Virginia Normal and Industrial Institute, Petersburg.

*Agricultural faculty.

*J. M. Gandy, A. M., Pd. D., *President.**G. W. Owens, M. S., *Dir. of Agr. School.**Cassie Bellinger, B. S., *Asst. in Dom. Art.**L. S. Boyer, B. S., *Instr. Voc. Agr.**L. A. Derbigny, A. B., *Instr. Chem.**Letitia I. Flowers, *Pract. Dom. Sci.**Mattie L. Jackson, B. S., *Asst. in Dom. Art.**A. A. Kildare, A. B., *Asst. in Chem.**H. F. McFadden, B. S., *Instr. An. Husb.**F. D. Patterson, D. V. M., *Instr. Vet. Sci.**Esther I. Tate, B. S., *Instr. Dom. Sci.**J. B. Tynes, *Instr. Farm Shop.**Pearl M. Vaughan, *Instr. Home Craft.**C. J. Wartman, *Pract. Agr.**Mamie L. White, *Libr.**Edwina M. Wright, B. S., *Dir. Home Econ.*

VIRGIN ISLANDS.

Agricultural Experiment Station, St. Croix.

Under the supervision of the Office of Experiment Stations, United States Department of Agriculture.

†Station staff.

†J. B. Thompson, B. S., *Agronomist in charge.*†W. M. Perry, *Hort. and Asst. in Ext.*| †M. S. Baker, B. S., *Asst. Agron.*

WASHINGTON.

State College of Washington, the Agricultural Experiment Station, and the Extension Service, Pullman.

*College faculty. †Station staff. ‡Extension staff.

*E. O. Holland, Ph. D., *President.**†E. C. Johnson, M. A., *Dean Coll. of Agr., Dir. of Sta.**†S. B. Nelson, D. V. M., *Dean and Dir. of Ext. Service.*H. V. Carpenter, M. S., *Dean Coll. of Mech. Arts and Engin., Dir. of Engin. Expt. Sta.***Animal Industry:** *†Howard Hackedorn, B. S.,
*Head Dept. of An. Husb.**†E. V. Ellington, B. S., *Head Dept. of Dairy Husb.**†J. S. Carver, B. S., *Head Dept. of Poultry Husb.*†G. C. Anderson, B. S., *Dairy Specialist.*†W. D. Buchanan, B. S., *Poultry Specialist.**L. W. Cassel, B. S., *Instr. Poultry Husb.**H. A. Collins, B. S., *Instr. Dairy Mfrs.*†C. M. Hubbard, B. S., *An. Husb. Specialist.*†F. W. Kherli, B. S., *Asst. Dairy Specialist.**†Joe Knott, B. S., *Herdsmen.*†D. G. Magruder, M. A., *Dairy Specialist.**A. H. Rishoi, B. S., *Instr. Dairy Mfrs.**R. T. Smith, B. S., *Instr. An. Husb.**†Jerry Sotola, M. S., *Asst. Prof. and Asst. An. Husb.**†R. D. Tucker, B. S., *Supt. Official Testing.***Bacteriology:** †S. C. Vandecaveye, Ph. D., *Bact.**Victor Burke, Ph. D., *Assoc. Prof. Bact.**L. A. Burkey, M. S., *Instr. Bact.**Vera E. Lautenschlager, M. A., *Instr. Bact.***Botany:** *F. L. Pickett, Ph. D., *Head of Dept.**Hannah C. Aase, Ph. D., *Asst. Prof. Bot.**Mildred E. Manuel, A. B., *Instr. Bot.**Harold St. John, Ph. D., *Asst. Prof. Bot.***C Chemistry:** *C. C. Todd, Ph. D., *Head of Dept.*†J. L. St. John, M. S., *Chem. (State Chem.).**C. M. Brewster, A. M., *Prof. Chem.**H. L. Cole, B. S., *Asst. Prof. Chem.**†R. P. Cope, M. S., *Assoc. Prof. Anal. and Agr. Chem.; Asst. Chem.**J. L. Culbertson, M. A., *Instr. Chem.**R. W. Gelbach, Ph. D., *Instr. Chem.*†E. L. Green, B. S., *Asst. Chem.**A. A. Levine, Ph. D., *Instr. Chem.*†J. R. Neller, Ph. D., *Asst. Chem.**Alice G. Paterson, A. B., *Asst. Prof. Anal. Chem.***Education (Agr.):** *D. W. Hamilton, Ph. D.,
*Prof. Agr. Ed.**F. J. Stevenson, B. S., *Instr. Agr. Ed.***Engineering (Agr.):** *†L. J. Smith, B. S., *Head of Dept.*

Engineering (Agr.)—Continued.

- *†O. L. Waller, Ph. M., *Head of Irrig. Div.*
Vice Pres. of Coll.
 †A. B. Crane, M. S., *Drainage Specialist.*
 *C. C. Johnson, B. A., *Instr. Agr. Engin.*

Extension (Admin.): †Dean and Dir. Nelson in charge.

- ‡R. M. Turner, B. S., *Asst. Dir.*
 †W. W. Underwood, B. S., *Asst. Dir.*
 †Maud M. Wilson, B. S., *Asst. Dir.*
 †Elmina White, B. S., *Asst. State Club Leader.*

Farm Crops and Farm Management: *†E. G. Schafer, M. S., *Head Dept. of Farm Crops.*

- *†George Severance, B. S., *Head Dept. of Farm Mgt. Vice Dean of Coll.*
 †O. E. Barbee, M. S., *Asst. in Farm Crops.*
 *†E. F. Gaines, D. Sc., *Assoc. Prof. Farm Crops; Cerealist (Coop. U. S. D. A.).*
 †R. N. Miller, B. S., *Farm Mgt. Specialist.*

Forestry: *E. H. Steffen, M. F., *Head of Dept.***Home Economics:** *Florence Harrison, M. A., *Dean Coll. of Home Econ.*

- *Edna I. Avery, A. M., *Head Div. of Clothing and Textiles.*
 *Leila W. Hunt, A. M., *Head Div. of Foods and Nutr.*
 †Eulalia B. Alger, B. S., *Clothing Specialist.*
 *Catherine T. Bryden, M. A., *Asst. Prof. Home Econ.*
 *Mary Elliott, B. S., *Asst. Dietitian.*
 *Vivian L. Garrett, B. S., *Instr. Home Econ.*
 *Nellie B. Jacobs, B. A., *Instr. Home Econ.*
 †M. Minerva Lawrence, B. S., *Home Mgt. Specialist.*
 *Alice H. Mustard, B. S., *Instr. Institutional Mgt., Asst. Dietitian.*
 *Helen K. Robson, B. S., *Asst. Prof. Home Econ.*
 *Mae M. Slemens, B. S., *Instr. Institutional Mgt.*
 *Ida M. Smith, *Supervising Dietitian.*
 †Mary E. Sutherland, B. S., *Foods and Nutr. Specialist.*

Horticulture: *†O. M. Morris, M. S., *Head of Dept.*

- †M. D. Armstrong, B. S., *Asst. Specialist in Hort.*
 †W. A. Luce, B. S., *Asst. Hort. (P. O., Wenatchee).*

Horticulture—Continued.

- *F. L. Overley, M. S., *Instr. Hort.*
 *C. L. Vincent, B. S., *Instr. Hort.*
Plant Pathology: *†F. D. Heald, Ph. D., *Head of Dept.*

- *†B. F. Dana, M. S., *Asst. Prof. and Asst. Plant Path.*

- †G. L. Zundel, M. S., *Plant Path.*
Soils: *†F. J. Sievers, M. S., *Head of Dept.*

- *A. F. Heck, M. S., *Asst. Prof. Soils.*
 †Leonard Hegnauer, B. S., *Soils and Crops Specialist.*
 †H. F. Holtz, M. S., *Asst. Soil Physicist.*

Veterinary Science: *E. E. Wegner, D. V. S., B. S., *Dean Coll. of Vet. Sci., Prof. Surg.*

- *S. L. Brown, B. S., D. V. S., *Instr. Anat. and Surg.*
 *J. A. Howarth, D. V. M., *Prof. Vet. Sci.*
 †J. W. Kalkus, D. V. S., *Vet. (P. O., Puyallup)*
 *J. E. McCoy, D. V. S., *Instr. Vet. Med.*
 *E. A. Rodier, D. V. M., *Instr. Path. and Bact.*

Zoology: *†A. L. Melander, Sc. D., *Head of Dept., Prof. Ent.; Ent.*

- *†W. T. Shaw, M. S., *Prof. Zool.; Zool.*
 †B. A. Slocum, B. S., *Specialist in Apiculture.*
 †Anthony Spuler, M. S., *Asst. Ent.*

Substations:

- Adams Branch Sta., P. O., *Lind—*
 M. A. McCall, M. S., *Supt.*
 H. M. Wanser, B. S., *Asst. in Crops and Soils.*
 Cranberry Lab., P. O., *Seaview—D. J. Crowley,*
 B. S., *Specialist in Cranberry Invest.*
 Irrig. Branch Sta., P. O., *Prosser—*
 R. P. Bean, B. S., *Supt. (Coop. U. S. D. A.).*
 T. R. Hall, M. S., *Asst. Hort.*
 H. P. Singleton, M. S., *Asst. in Soils and Crops.*
 C. C. Wright, B. S., *Specialist in Irrig. Invest.*
 (Coop. U. S. D. A.).
 Waterville Branch Sta., P. O., *Waterville—C. E.*
 Hill, B. S., *Supt. (Coop. U. S. D. A.).*

Western Washington Station, P. O., Puyallup:

- W. A. Linklater, B. S., *Supt.*
 Arthur Frank, B. S., *Plant Path.*
 W. T. Johnson, B. S., D. V. M., *Vet.*
 M. E. McCollam, B. S., *Agron.*
 H. D. Locklin, M. S., *Hort.*
 G. R. Shoup, *Poultryman.*
 Mrs. G. R. Shoup, *Poultry Specialist.*

WEST VIRGINIA.**College of Agriculture and Agricultural Experiment Station of West Virginia University, Morgantown.**

*College faculty. †Station staff. ‡Extension staff.

- *F. B. Trotter, A. M., LL. D., *President of University.*
 *G. R. Lyman, Ph. D., *Dean Coll. of Agr.*
 †H. G. Knight, Ph. D., *Dir. of Sta.*
 †N. T. Frame, A. B., *Dir. of Agr. Ext. Div.*
 C. R. Jones, M. M. E., *Dean Coll. of Engin.*

Agronomy: *†R. J. Garber, Ph. D., *Prof. Agron.; Agron.*

- ‡D. R. Dodd, M. S., *Agron. Specialist.*
 *†T. E. Odland, M. S., *Asst. Prof. and Asst. Agron.*
 *†K. S. Quisenberry, B. S., *Instr. and Junior Agron.*

Animal and Poultry Husbandry: *†E. A. Live-

- say, M. S., *Prof. An. Husband.; An. Husband.*
 †Horace Atwood, M. S., *Poultry Husband.*
 *E. L. Andrews, B. S., *Assoc. Prof. Poultry Husband.*
 †B. F. Creech, B. S., *Beef Cattle and Hog Specialist.*

† For subject-matter workers see the respective division, i. e., animal industry, bacteriology, etc.

Animal and Poultry Husbandry—Continued.

- *†E. L. Shaw, B. S., *Instr. An. Husb., Sheep Specialist.*
 *†E. C. Stillwell, M. S., *Instr. and Junior An. Husb.*
 †R. H. Tuckwiller, B. S., *Asst. in An. Husb. (Coop. U. S. D. A.).*
 *†C. V. Wilson, B. S., *Instr. and Junior An. Husb.*

Chemistry: Director Knight in charge.

- †T. J. Cochrane, B. S., *Junior Chem.*
 †F. B. Kunst, A. B., *Asst. Chem.*
 †T. B. Leith, A. B., *Asst. Chem.*
 †C. E. Weakley, jr., *Asst. Chem.*

Dairy Husbandry: *†E. L. Anthony, M. S., *Prof. Dairy Husb.: Dairy Husb.*

- *†Warren Gifford, B. S., *Asst. in Dairy Husb.*
 *†H. O. Henderson, M. S., *Assoc. Prof. and Assoc. Dairy Husb.*
 †J. V. Hopkins, B. S., *Dairy Specialist.*
 *†G. M. Trout, B. S., *Asst. in Dairy Husb.*

Economics (Agr.): *†A. J. Dadisman, M. S., *Assoc. Prof. Farm Econ.; Assoc. Farm Economist.*

- †A. H. Rapking, B. D., *Rural Organ.*
 *†J. H. Shaffer, B. S., *Asst. in Farm Econ.*

Education (Agr.): *H. B. Allen, M. S., *Assoc. Prof. Agr. Ed.*

- *R. A. Olney, M. S., *Asst. Prof. Agr. Ed.*
 *D. W. Parsons, M. S., *Instr. and Asst. Supvr. Voc. Agr.*

Engineering (Agr.): *†F. D. Cornell, jr., B. S., *Instr. and Junior Farm Mech.*

- *F. F. Shafer, C. E., *Drainage Engin.*

Entomology: *†L. M. Peairs, M. S., *Prof. Ent.; Ent.*

- †W. E. Rumsey, B. S., *Asst. Ent. (State Ent.).*

Extension (Admin.):¹ Director Frame in charge.

- †C. H. Hartley, B. S., *Asst. Dir.*
 †H. S. Vandervort, B. S., *Asst. Dir. in charge Coop. Work with Counties.*
 †W. H. Kendrick, B. S., *Asst. Dir. in charge Club Work.*
 †Margaret Ford, B. S., *State Home Dem. Agt.*
 †Hazel Horsfall, B. S., *State Club Agt.*

Home Economics: *Rachel H. Colwell, A. M., *Prof. Home Econ.*

- *Marion F. Breck, M. S., *Asst. Prof. Ed. and Home Econ.*
 *Margaret J. Chambers, B. S., *Instr. Home Econ.*
 *Isabelle D. Lowe, B. S., *Instr. Home Econ.*
 *Mary A. Milner, B. S., *Instr. Home Econ.*
 *Ruth K. Trail, M. S., *Asst. Prof. Home Econ.*

Horticulture: *†M. J. Dorsey, Ph. D., *Prof. Hort.; Hort.*

- *†Ernest Angelo, B. S., *Instr. and Junior Hort.*
 †Dee Crane, *Potato Specialist.*
 *†H. L. Crane, M. S., *Assoc. Prof. and Assoc. Hort.*
 *†T. M. Currence, B. S., *Asst. in Hort.*
 †D. T. Gray, B. S., *Hort. Specialist.*
 *†H. E. Knowlton, Ph. D., *Assoc. Prof. and Assoc. Hort.*
 †H. W. Prettyman, B. S., *Supt. Spray and Packing Service (P. O., Inwood).*
 *†K. C. Westover, B. S., *Asst. Prof. and Asst. Hort.*

Journalism: *††C. E. Stockdale, B. S., *Instr. Agr. Journalism; Agr. Editor.***Plant Pathology:** *†N. J. Giddings, Ph. D., *Prof. Plant Path.; Plant Path.*

- †Anthony Berg, B. S., *Asst. Plant Path.*
 *†L. H. Leonian, Ph. D., *Asst. Prof. and Asst. Plant Path.*

- ††E. C. Sherwood, M. S., *Asst. Plant Path., Specialist in Plant Diseases and Insects.*

Soils: *†E. P. Deatrick, Ph. D., *Assoc. Prof. Soils; Assoc. Soil Tech.***Veterinary Science:** *††C. A. Lueder, D. V. M., *Assoc. Prof. Vet. Sci.; Assoc. Vet.***Miscellaneous:**

- *L. D. Arnett, Ph. D., *Libr.*

Substations:

- Maggie Substa., *P. O., Maggie*—T. C. Mellvaine, M. S., *Asst. Agron. in charge (Coop. U. S. D. A.).*
 Reymann Memorial Farms, *P. O., Wurdensville*—L. F. Sutton, B. S., *Supt. and Asst. Hort.*

The West Virginia Collegiate Institute, Institute.***Agricultural faculty.**

*J. W. Davis, A. M., *President.*

*A. W. Curtis, M. Agr., *Dir. of Agr. Dept.*

*Miss E. J. Anderson, B. S., *Dom. Arts and Sci.*

*Mrs. Portia S. Blackiston, *Dom. Arts.*

*Mary E. Eubank, *Supt. of Home Econ. Dept.*

*A. P. Hamblin, B. S., *Biol.*

*R. W. James, *Asst. Dir. Agr. Dept.*

*Exie L. Kelly, B. S., *Dir. Teacher Training in Home Econ.*

*D. M. Prillerman, B. S., *Chem.*

*Ednora Prillerman, *Dom. Sci.*

*W. F. Savoy, *Libr.*

*Mabel Sinkford, *Home Nursing.*

*Mrs. Amanda D. Spriggs, *Dom. Arts.*

¹ For subject-matter workers see the respective division, i. e., agronomy, animal husbandry, etc.

WISCONSIN.

College of Agriculture and the Agricultural Experiment Station of the University of Wisconsin,
Madison.

*College faculty. †Station staff. ‡Extension staff.

*E. A. Birge, Ph. D., Sc. D., LL. D., *President of University.*

*†H. L. Russell, Ph. D., *Dean Coll. of Agr., Dir. of Sta., Dir. of Agr. Ext. Service.*
F. E. Turneaure, C. E., D. Eng., *Dean Coll. of Engin.*

Agronomy: *†R. A. Moore, *Chair. of Dept.*

*†H. W. Albertz, M. S., *Instr. and Asst. Agron.*

*G. M. Briggs, B. S., *Asst. Prof. Agron.*

*†E. J. Delwiche, M. S., *Prof. Agron. (P. O., Green Bay).*

*†L. F. Graber, M. S., *Prof. Agron.; Agron.*

*†E. D. Holden, M. S., *Instr. and Asst. Agron.*

†George Janssen, M. S., *Asst. in Agron.*

*†B. D. Leith, B. S., *Assoc. Prof. Agron.; Agron.*

*†G. B. Mortimer, B. S., *Assoc. Prof. Agron.; Agron.*

*†A. L. Stone, *Asst. Prof. and Asst. Agron.*

*†A. H. Wright, M. S., *Assoc. Prof. Agron.; Agron. (Coop. U. S. D. A.).*

Animal and Poultry Husbandry: *†G. C.

Humphrey, B. S., *Chair. An. Husb. Dept.*

*†J. G. Halpin, B. S., *Chair. Poultry Husb. Dept.*

†H. J. Brant, M. S., *An. Husb. Specialist.*

†A. O. Collettine, *An. Husb. Specialist.*

†A. J. Cramer, B. S., *Supvr. in charge Cow*

Testing Assoc. (Coop. U. S. D. A.).

*†J. M. Fargo, M. S., *Asst. Prof. and Asst. An. Husb.*

*†J. G. Fuller, B. S. *Prof. An. Husb.; An. Husb.*

†R. T. Harris, *Supvr. in charge Dairy Tests.*

†J. B. Hayes, B. S., *Asst. Prof. Poultry Husb.*

*†R. S. Hulce, M. S., *Assoc. Prof. An. Husb.; An. Husb.*

*†O. N. Johnson, *Asst. in Poultry Husb.*

*††Frank Kleinheinz, *Asst. Prof. and Asst. An. Husb. (Sheep Work).*

*†C. E. Lampman, B. S., *Instr. Poultry Husb.*

*†A. W. Lathrop, M. S., *Asst. in An. Husb.*

*†F. B. Morrison, B. S., *Prof. An. Husb.; An. Husb. and Asst. Dir. of Sta.*

†R. F. Murray, B. S., *An. Husb. Specialist.*

*S. D. Sims, B. S., *Instr. An. Husb.*

Bacteriology: *††E. G. Hastings, M. S., *Chair. of Dept.*

*†Freda M. Bachmann, Ph. D., *Instr. and Asst. Agr. Bact.*

*†W. R. Carroll, B. S., *Asst. in Agr. Bact.*

*†W. C. Frazier, B. S., *Instr. and Asst. Agr. Bact.*

*†E. B. Fred, Ph. D., *Prof. Agr. Bact.; Agr. Bact.*

*††W. D. Frost, Ph. D., Dr. P. H., *Prof. Agr. Bact.; Agr. Bact.*

*Edith Haynes, M. S., *Asst. in Agr. Bact.*

*†J. W. Stevens, M. S., *Asst. in Agr. Bact.*

*A. L. Whiting, Ph. D., *Assoc. Prof. Agr. Bact.*

*†W. H. Wright, M. S., *Assoc. Prof. Agr. Bact.; Agr. Bact.*

Chemistry: *†E. B. Hart, B. S., *Chair. of Dept.*

*†Archie Black, B. S., *Asst. in Agr. Chem.*

*†C. A. Elevehjem, B. S., *Asst. in Agr. Chem.*

*†J. H. Jones, M. S., *Asst. Agr. Chem.*

*†Samuel Lepkovsky, B. S., *Instr. and Asst. Agr. Chem.*

Chemistry—Continued.

*Mrs. Mariana S. Nelson, M. S., *Instr. Agr. Chem.*

*†W. H. Peterson, Ph. D., *Assoc. Prof. Agr. Chem.; Agr. Chem.*

†E. G. Schmidt, B. S., *Asst. in Agr. Chem.*

*†Harry Steenbock, Ph. D., *Prof. Agr. Chem.; Agr. Chem.*

*W. H. Stroud, Ph. D., *Lect. in Agr. Chem.*

*†W. E. Tottingham, Ph. D., *Assoc. Prof. Agr. Chem.; Agr. Chem.*

Dairy Husbandry: *††E. H. Farrington, M. S., *Chair. of Dept.*

*††J. L. Sammis, Ph. D., *Assoc. Prof. Dairy Husb.; Dairy Husb.*

*†H. H. Sommer, Ph. D., *Asst. Prof. and Asst. Dairy Husb.*

*†L. C. Thomsen, G. A., *Instr. and Asst. Dairy Husb.*

Economics (Agr.): *††B. H. Hibbard, Ph. D., *Chair. of Dept.*

†J. S. Donald, D. D. S., *Agr. Econ. Specialist (Coop. U. S. D. A.).*

*W. W. Fetrow, B. S., *Asst. in Agr. Econ.*

*†A. J. Haas, *Asst. in Agr. Econ.*

†Stella Jacobus, *Asst. in Agr. Econ.*

*O. M. Johnson, B. S., *Asst. in Agr. Econ.*

*††J. H. Kolb, Ph. D., *Assoc. Prof. Agr. Econ. (Rural Life); Agr. Econ.*

*†P. E. McNall, M. S., *Assoc. Prof. Agr. Econ.; Agr. Econ.*

*†Theodore Macklin, Ph. D., *Prof. Agr. Econ.; Agr. Econ.*

*M. C. Riley, LL. B., *Lect. in Agr. Econ.*

*Eleazer Tetreau, M. A., *Lect. in Agr. Econ.*

*F. L. Thomsen, M. S., *Asst. in Agr. Econ.*

Education (Agr.): *J. A. James, B. S., *Chair. of Dept. and Asst. Dean of Resident Instr.*

*K. L. Hatch, B. S., *Prof. Agr. Ed.*

*†E. M. Tiffany, M. S., *Asst. Prof. Agr. Ed.*

Engineering (Agr.): *††E. R. Jones, M. S., *Chair. of Dept.*

*George Arbuthnot, B. S., *Asst. in Agr. Engin.*

*††F. W. Duffee, B. S., *Assoc. Prof. and Asst. Agr. Engin.*

*†N. S. Fish, B. S., *Asst. Agr. Engin.*

*†E. R. Meacham, B. S., *Asst. in Agr. Engin.*

†W. A. Rowlands, B. S., *Agr. Engin. Specialist (Land Clearing).*

*††J. H. Swenhardt, B. S., *Prof. Agr. Engin. (Land Clearing); Agr. Engin.*

†O. R. Zeasman, B. S., *Asst. Prof. Agr. Engin.*

Entomology: *††H. F. Wilson, M. S., *Chair. of Dept.*

*††C. L. Fluke, jr., M. S., *Asst. Prof. and Asst. Econ. Ent.*

*†A. A. Granovsky, M. S., *Instr. and Asst. Econ. Ent.*

*†V. G. Milum, M. S., *Instr. and Asst. Econ. Ent.*

†L. P. Whitehead, B. S., *Instr. Econ. Ent. (Coop. U. S. D. A.).*

Extension (Admin.):¹ Director Russell in charge.

- †K. L. Hatch, B. S., *Asst. Dir. in charge.*
- †J. F. Wojta, M. S., *County Agt. Leader.*
- †T. L. Bewick, M. S., *State Club Leader.*
- †G. M. Briggs, B. S., *Asst. County Agt. Leader.*
- †W. W. Clark, B. S., *Asst. County Agt. Leader.*
- †Mildred I. Hagerty, B. S., *Asst. State Club Leader.*
- †E. L. Luther, B. S., *Supvr. Ext. Courses and Schools and Supt. Farmers' Insts.*
- †Wakelin McNeel, B. S., *Asst. State Club Leader.*

Genetics: *†L. J. Cole,² Ph. D., *Chair. of Dept.*

- †F. A. Abegg, M. S., *Asst. in Genetics.*
- *†R. A. Brink, D. Sc., *Asst. Prof. Genetics; Asst. Geneticist.*
- †Augustin Rodolfo, B. S., *Asst. in Genetics.*
- †A. A. Saunders, B. S., *Asst. in Genetics.*
- †D. G. Steele, M. S., *Asst. in Genetics.*
- †Henry Stevens, M. S., *Asst. in Genetics.*
- †E. E. Van Lone, B. S., *Asst. in Genetics.*

Home Economics: *†Abby L. Marlatt, M. S., *Chair. of Dept. and Dir. of Courses.*

- *Ann G. Braun, M. S., *Instr. Home Econ.*
- †Lucy A. Case, B. S., *Home Econ. Specialist.*
- *Mrs. Olive L. Cooper, B. S., *Instr. Home Econ.*
- *Florence Corbin, B. S., *Instr. Home Econ.*
- *May L. Cowles, M. S., *Asst. Prof. Home Econ.*
- *Eleanor R. Craighill, B. S., *Instr. Home Econ.*
- *Bernice F. Dodge, B. S., *Asst. Prof. Home Econ.*
- †Wealthy Hale, B. S., *Home Econ. Specialist.*
- *Ruth Henderson, B. S., *Asst. Prof. Home Econ.*
- *Ellen G. Hillstrom, B. S., *Asst. Prof. Home Econ.*
- †Mrs. Nellie K. Jones, M. S., *State Leader Home Econ. Ext.*
- *Alice Kinslow, B. S., *Instr. Home Econ.*
- †Sadie A. McNulty, B. S., *Home Econ. Specialist.*
- *Hazel Manning, M. S., *Asst. Prof. Home Econ.*
- †Gladys L. Meloche, M. S., *Home Econ. Specialist.*
- *Dorothy R. Mendenhall, M. D., *Lect. in Home Econ.*
- *Ruth H. Myrland, B. A., *Asst. to Chair. of Dept.*
- *Helen T. Parsons, M. S., *Asst. Prof. Home Econ.*
- †Mary Purcell, B. S., *Home Econ. Specialist.*
- *Eva S. Schairer, B. S., *Instr. Home Econ.*
- †Margaret Schwenker, B. S., *Asst. Home Econ.*
- †Gladys S. Stillman, Ph. B., *Home Econ. Specialist.*
- *Dorothy B. Wood, B. S., *Instr. Home Econ.*
- *Mrs. Mabel Wood, M. S., *Instr. Home Econ.*

Horticulture: *†J. G. Moore, M. S., M. H., *Chair. of Dept.*

- *†F. A. Aust, M. S., *Assoc. Prof. Hort. (Landscape Design).*
- †Dorothy Bradbury, M. A., *Asst. in Hort.*
- †J. W. Brann, M. S., *Asst. Prof. Hort.*
- †F. H. Gifford, *Orchard and Gard. Dem.*
- *†James Johnson, Ph. D., *Prof. Hort.; Hort.*
- *†Laura R. Kremers, B. A., *Asst. in Hort.*
- *†C. L. Kuehner, B. S., *Hort. Specialist.*
- *†M. E. Luther, B. S., *Hort. Specialist.*

¹ For subject-matter workers see the respective division, i. e., agronomy, animal husbandry, etc.² On leave.**Horticulture:**—Continued.

- *†J. G. Milward, M. S., *Prof. Hort.; Hort.*
 - *Maurice Mulvania, M. S., *Instr. Hort.*
 - *†G. T. Nightingale, M. S., *Instr. and Asst. Hort.*
 - *†R. H. Roberts, M. S., *Assoc. Prof. Hort.; Hort.*
- Journalism:** *†A. W. Hopkins, B. L., *Chair. of Dept., Editor.*
- *†Grace E. Langdon, B. S., *Instr. Agr. Journalism.*
 - *†W. A. Sumner, B. S., *Assoc. Prof. Agr. Journalism, Asst. Editor.*
- Plant Pathology:** *†L. R. Jones, Ph. D., D. Sc., *Chair. of Dept.*
- †J. W. Brann, M. S., *Asst. Prof. Plant Path.*
 - *†J. G. Dickson, Ph. D., *Assoc. Prof. and Plant Path. (Coop. U. S. D. A.).*
 - *E. M. Gilbert, Ph. D., *Prof. Plant Path.*
 - †George Janssen, M. S., *Asst. in Plant Path.*
 - *†L. K. Jones, Ph. D., *Instr. and Asst. Plant Path. (Coop. U. S. D. A.).*
 - *†G. W. Keitt, Ph. D., *Prof. Plant Path.; Plant Path.*
 - *R. B. Streets, M. S., *Instr. Plant Path.*
 - †R. E. Vaughan, M. S., *Assoc. Prof. Plant Path.*
 - †E. F. Vestal, M. S., *Asst. in Plant Path.*
- Soils:** *†A. R. Whitson, B. S., *Chair. of Dept.*
- †A. R. Albert, B. S., *Asst. in Soils (P. O., Hancock).*
 - †C. J. Chapman, B. S., *Asst. Prof. Soils and Chem. in State Soils Lab.*
 - *W. J. Geib, M. Agr., *Asst. Prof. Soils, Soil Survey Work (Coop. U. S. D. A.).*
 - *†E. J. Graul, M. S., *Asst. Prof. and Asst. in Soils.*
 - *†F. L. Musbach, B. S., *Assoc. Prof. Soils (P. O., Marshfield).*
 - *†Griffith Richards, B. S., *Asst. Prof. Soils.*
 - *†H. W. Stewart, B. S., *Asst. Prof. and Asst. in Soils.*
 - *†Emil Truog, M. S., *Prof. Soils; Soils.*
 - ††H. W. Ullsperger, B. S., *Asst. Prof. Soils (P. O., Sturgeon Bay).*
 - †O. R. Zeasman, B. S., *Asst. Prof. Soils.*
- Veterinary Science:** *†F. B. Hadley, D. V. M., *Chair. of Dept.*
- *A. S. Alexander, F. H., A. S., M. D. C., *Prof. Vet. Sci.*
 - *†B. A. Beach, D. V. M., *Assoc. Prof. Vet. Sci.; Vet.*
 - ††E. M. Gildow, D. V. M., *Asst. in Vet. Sci.*
- Miscellaneous:**
- ††W. H. Ebling, B. S., *Asst. to Dean and Dir.*
 - †A. J. Haas, *Executive Secy.*
 - *†C. S. Hearn, B. A., *Libr.*
 - *†Mable C. Little, B. S., *Assoc. Prof. Institutional Admin.*
 - *†Margaret E. Smith, B. A., *Asst. in Institutional Admin.*
- Substations:**
- Ashland, Spooner, and Peninsular Stas.—E. J. Delwiche, M. S., *in charge (P. O., Green Bay).*
 - Coddington—
 - Cranberry Sta., P. O., Wisconsin Rapids—
 - , *in charge.*
 - Hancock—H. W. Ullsperger, B. S., *in charge (P. O., Sturgeon Bay).*
 - Marshfield—F. L. Musbach, B. S., *in charge.*

WYOMING.

College of Agriculture and the Agricultural Experiment Station of the University of Wyoming,
Laramie.

*College faculty. †Station staff. ‡Extension staff.

*A. G. Crane, Ph. D., *President.*

*†J. A. Hill, B. S., *Dean Coll. of Agr., Dir. of Sta. Wool Specialist.*

†A. E. Bowman, B. S., *Dir. of Agr. Ext.*

J. C. Fitterer, C. E., *Engineering.*

Agronomy: *†A. F. Vass, M. S., *Prof. Agron.; Agron.*

*†Glen Hartman, B. S., *Asst. Prof. and Asst. Agron.*

†R. O. Westley, M. S., *Farm Crops Specialist.*

Animal Industry: *†F. S. Hultz, M. S., *Assoc. Prof. An. Husb.; An. Husb.*

†H. F. Eaton, B. S., *Asst. Wool Specialist.*

*†F. J. Kohn, B. S., *Instr. and Asst. Poultry Husb.*

*†E. B. Krantz, M. S., *An. Husb. in charge Horse Brdg. Farm (Coop. U. S. D. A.).*

†W. H. McNeas, B. S., *Poultry Specialist.*

*†L. P. Reeve, B. S., *Instr. and Asst. An. Husb.*

†D. J. Robertson, B. S., *Livestock and Dairy Specialist.*

*†H. S. Willard, M. S., *Instr. and Asst. An. Husb.*

Botany: *†Aven Nelson, Ph. D., *Prof. Bot.; Bot.*

*†E. B. Payson, Ph. D., *Assoc. Prof. Bot.; Bot.*

†R. U. Cotter, B. S., *Specialist in Barberry Erad. Work (Detailed by U. S. D. A.).*

Chemistry: *L. E. Walter, M. S., *Prof. Chem. (State Chem.).*

*†O. A. Beath, M. A., *Prof. Chem.; Head Research Chem.*

†A. T. Cundy, A. R. C. Sc., *Asst. Research Chem.*

*†F. E. Hepner, M. S., *Assoc. Prof. and Asst. Research Chem.*

*P. T. Miller, M. A., *Prof. Chem.*

†E. R. Schierz, Ph. D., *Asst. Research Chem.*

Education (Agr.): *S. H. Dadisman, M. S., *Assoc. Prof. Agr. Ed.*

Engineering (Agr.): Professor Fitterer in charge.

Extension (Admin.):¹ Director Bowman in charge.

†F. P. Lane, B. S., *County Agt. Leader.*

†Mary Rokahr, A. B., *State Home Dem. Leader.*

†A. R. Chase, B. S., *State Club Leader.*

†Alta J. Emerson, B. S., *Asst. State Club Leader*

†G. W. O'Roke, *Admin. Asst.*

Home Economics: *Elizabeth J. McKittrick, Ph. D., *Assoc. Prof. Home Econ.*

*Olga M. Hoesly, M. S., *Asst. Prof. Teacher Training in Home Econ.*

*Bernice Tucker, B. S., *Instr. Home Econ.*

*Katherine A. Waller, B. S., *Asst. Prof. Home Econ.*

†Charlotte E. Weiss, B. S., *Clothing Specialist.*

Veterinary Science: *†Cecil Elder, D. V. M., *Assoc. Prof. and Head Dept. of Vet. Sci. and Bact.; Research Path.*

*†A. M. Lee, D. V. M., *Instr. Vet. Sci. and Bact.; Asst. in An. Diseases.*

Zoology: *†J. W. Scott, Ph. D., *Prof. Zool.; Research Parasitol.*

*C. L. Corkins, M. S., *Asst. Prof. Ent. (State Ent.).*

†A. M. Day, B. S., *Junior Biol. (Detailed by U. S. D. A.).*

*†E. C. Harrah, Ph. D., *Assoc. Prof. Zool.; Asst. Parasitol.*

Miscellaneous:

*Reba Davis, B. L. S., *Libr.*

†Marion V. Higgins, B. S., *Libr.*

†W. L. Quayle, B. S., *Dir. Div. of State Farms.*

¹ For subject-matter workers see the respective division, i. e., agronomy, animal industry, etc.



INDEX OF NAMES.

PART 2.

- Aamodt, C. G., 34.
 Aase, H. C., 68.
 Abbey, M. J., 40.
 Abbott, C. E., 11.
 Abbott, C. L., 2.
 Abbott, F. H., 5.
 Abbott, J. B., 30.
 Abbott, R. C., 41.
 Abbott, W. C., 28.
 Abegg, F. A., 72.
 Abell, M. F., 31.
 Abell, T. H., 66.
 Ackerman, W. T., 67.
 Ackerson, C. W., 41.
 Ackert, J. E., 25.
 Adair, Mrs. D. W., 2.
 Adams, B., 48.
 Adams, C. S., 37.
 Adams, F., 6.
 Adams, G. E., 59.
 Adams, J. E., 51.
 Adams, J. F., 10.
 Adams, J. W., 8.
 Adams, M., 42.
 Adams, M. G., 52.
 Adams, O. V., 8.
 Adams, R. L., 6.
 Adams, R. M., 47.
 Adams, W. L., 60.
 Addy, R. H., 32.
 Adriance, G. W., 65.
 Agar, H. L., 17.
 Agee, H. P., 14.
 Agnew, M. A., 1.
 Ahlson, C. B., 14.
 Ahrens, I. V., 21.
 Aieher, L. C., 25.
 Aiken, J. B., 10.
 Aitken, W. A., 23.
 Aitkenhead, W., 18.
 Aitkenhead, W. C., 18.
 Albert, A. R., 72.
 Albert, D. W., 3.
 Albertz, H. W., 71.
 Albrecht, W. A., 39.
 Alcock, J. R., 30.
 Alex, Mrs. O. S., 22.
 Alder, B., 65.
 Alderman, G. W., 31.
 Alderman, O. A., 54.
 Alderman, W. H., 35.
 Alex, A. H., 64.
 Alexander, A. S. (N. Mex.), 45.
 Alexander, A. S. (Wis.), 72.
 Alexander, C. P., 31.
 Alexander, E. D., 12.
 Alexander, J. M., 65.
 Alexander, W. H., 54.
 Alford, C. H., 7.
 Alford, S. W., 42.
 Alger, E. B., 69.
 Alger, H. B., 46.
 Allard, H. W., 25.
 Allbaugh, L. G., 20.
 Allen, A. A., 48.
 Allen, C. L., 46.
 Allen, E. W., III.
 Allen, F. J., 18.
 Allen, F. L., 52.
 Allen, F. W., 7.
 Allen, H. B. (N. J.), 43.
 Allen, H. B. (W. Va.), 70.
 Allen, H. L., 31.
 Allen, H. R., 27.
 Allen, H. W., 37.
 Allen, J. C., 19.
 Allen, L. J., 56.
 Allen, P. W., 62.
 Allen, W. H., 43.
 Allison, I. M. K., 8.
 Allison, J. H., 35.
 Allred, C. E., 63.
 Almy, E. F., 52.
 Alway, F. J., 36.
 Amadon, R. S., 51.
 Ambrose, A. S., 16.
 Ambrose, M. A., 63.
 Ames, C. T., 37.
 Ames, J. W., 53.
 Amidon, E., 35.
 Amos, E. G., 32.
 Amundson, G., 33.
 Anderegg, L. T., 20.
 Anders, C. B., 37.
 Anders, I. A., 21.
 Andersen, E. N., 41.
 Anderson, A., 41.
 Anderson, A. B. (Ariz.), 3.
 Anderson, A. B. (Ark.), 4.
 Anderson, A. K., 58.
 Anderson, A. L., 19.
 Anderson, B. G., 67.
 Anderson, B. M., 23.
 Anderson, C. R., 58.
 Anderson, C. S., 16.
 Anderson, E., 35.
 Anderson, E. E., 55.
 Anderson, E. J., 70.
 Anderson, E. O., 41.
 Anderson, F. P., III, 26.
 Anderson, G. C. (Ida.), 14.
 Anderson, G. C. (Wash.), 68.
 Anderson, G. F., 66.
 Anderson, H. W., 17.
 Anderson, J. A., 36.
 Anderson, J. C., 15.
 Anderson, M. A., 51.
 Anderson, M. B., 27.
 Anderson, O. G., 19.
 Anderson, P. A., 34.
 Anderson, P. J., 31.
 Anderson, R. G., 19.
 Anderson, R. J., 48.
 Anderson, R. L., 4.
 Anderson, W. A., 50.
 Anderson, W. C., 37.
 Anderson, W. S., 26.
 Andrew, R. E., 10.
 Andrews, E. L., 69.
 Andrews, Mrs. E. M., 64.
 Andrews, K., 32.
 Andrews, M. E., 55.
 Angelo, E., 70.
 Ankeney, J. V., 38.
 Annan, M. C., 9.
 Anthony, E. L., 70.
 Anthony, R. D., 58.
 Apperson, K., 67.
 Appleman, C. O., 30.
 Appleton, H. C., 12.
 Arbour, M. B., 27.
 Archibald, G., 71.
 Archibald, J. G., 31.
 Arey, J. A., 49.
 Armes, M. J., 58.
 Armstrong, F. E., 15.
 Armstrong, G. B., 17.
 Armstrong, L. O., 50.
 Armstrong, M. D., 69.
 Armstrong, W. F., 49.
 Arneson, R., 22.
 Arnett, C. N., 40.
 Arnett, L. D., 70.
 Arnold, C. R., 52.
 Arnold, E. M., 25.
 Arnold, F. R., 66.
 Arnquist, J. A., 21.
 Arny, A. C., 34.
 Arrington, M. B., 65.
 Arthur, C. M., 34.
 Asbury, S. E., 64.
 Ashbaugh, W. W., 17.
 Ashworth, J. T., 10.
 Atkeson, F. W., 14.
 Atkinson, A., 40.
 Atkinson, T. W., 27.
 Atwood, F. J., 41.
 Atwood, H., 69.

- Atwood, M. V., 48.
 Atwood, R. B., 65.
 Atwood, W. M., 56.
 Aubel, C. E., 23.
 Auchter, E. C., 30.
 Aull, G. H., 61.
 Aull, W. B., 60.
 Aust, F. A., 72.
 Austin, C. L., 7.
 Austin, E., 17.
 Austin, E. L., 19.
 Austin, R. H., 4.
 Averill, A. W., 29.
 Averitt, S. D., 26.
 Avery, E. I., 69.
 Avery, G. T., 8.
 Avery, R. C., 31.
 Avery, S., III, 41.
 Axt, R. W., 17.
 Axtell, F. E., 46.
 Ayers, E. L., 11.
 Ayres, J. C., 14.
 Ayres, Q. C., 21.
 Ayres, W. E. (Miss.), 37.
 Ayres, W. E. (N. Y.), 46.

 Babcock, E. B., 6.
 Bachmann, F. M., 71.
 Backus, L. S., 39.
 Badger, C. J., 15.
 Baer, A. A., 41.
 Baer, A. C., 54.
 Baerg, W. J., 4.
 Bahnsen, P. F., 2.
 Baie, E. A., 43.
 Bailey, C. H., 34.
 Bailey, E. M., 10.
 Bailey, F., 66.
 Bailey, G. W., 66.
 Bailey, J. S., 31.
 Baker, A. L. (Mont), 40.
 Baker, A. L. (Pa.), 58.
 Baker, C. A., 8.
 Baker, C. C., 18.
 Baker, C. E., 19.
 Baker, G. J., 51.
 Baker, G. L., 10.
 Baker, H. J., III, 43.
 Baker, H. R., 10.
 Baker, K. G., 1.
 Baker, M. M., 22.
 Baker, M. P., 20.
 Baker, M. S., 68.
 Baker, T. A., 10.
 Baker, W. G., 21.
 Bakke, A. L., 20.
 Balch, W. B., 25.
 Baldwin, E. J., 14.
 Baldwin, F. M., 23.
 Baldwin, G. H., 59.
 Baldwin, I. L., 18.
 Baldwin, R. J., 32.
 Bales, A., 51.
 Ball, A. S., 31.
 Ball, C. D., 32.
 Ball, E. D., III.
 Ball, G. I., 44.

 Ball, O. M., 64.
 Ballantyne, A. B., 3.
 Ballard, C. V., 32.
 Ballard, F. L., 56.
 Ballard, W. R., 30.
 Ballou, F. H., 54.
 Balmer, F. E., 35.
 Baltzer, A. C., 32.
 Bancroft, C., 52.
 Bancroft, L., 29.
 Bane, G. M., 52.
 Banks, R. A., 2.
 Banta, L., 30.
 Barbee, O. E., 69.
 Bardsley, J. H., 19.
 Barer, A. P., 17.
 Barger, E. H., 7.
 Barham, J. F., 39.
 Barkas, B. W., 46.
 Barker, Mrs. E., 21.
 Barker, H. D., 37.
 Barker, J. R., 40.
 Barker, P. I., 21.
 Barkman, J. O., 26.
 Barlow, J., 60.
 Barner, J. A., 51.
 Barnes, B. F., 25.
 Barnes, Mrs. D. R., 64.
 Barnes, E. E., 53.
 Barnes, G., 30.
 Barnes, G. F., 37.
 Barnes, G. W., 64.
 Barnes, I. M., 17.
 Barnes, M. C., 1.
 Barnett, A., 3.
 Barnett, E., 36.
 Barnett, R. J., 25.
 Barnhart, A. S., 58.
 Barr, G. W., 42.
 Barre, H. W., 60.
 Barrett, DuP., 12.
 Barrett, J. T., 7.
 Barron, J. H., 45.
 Barrow, D. N., 27.
 Barrows, W. M., 53.
 Barrus, M. F., 48.
 Barry, Mrs. M. W., 64.
 Barss, H. P., 56.
 Bartel, F. O., 50.
 Bartholomew, E. T., 7.
 Bartholomew, H., 17.
 Bartlett, J. M., 28.
 Bartlett, J. W., 43, 44.
 Bartley, M. A., 31.
 Barto, H. T., 17.
 Barton, O. A., 51.
 Barts, A. A., 47.
 Basore, C. A., 1.
 Bassett, L. B., 34.
 Batchelder, C. H., 28.
 Batchelor, E. M., 24.
 Batchelor, H. W., 14.
 Batchelor, L. D., 7.
 Bateman, J. R., 66.
 Bates, E., 47.
 Bates, M., 25.
 Bates, S. L., 22.

 Bates, W. E., 6.
 Batten, E. T., 67.
 Bauer, F., 60.
 Bauer, F. C., 15.
 Bauer, G., 64.
 Baver, L. D., 54.
 Baxter, R. L., 32.
 Bayles, B. B., 57.
 Bayles, J. J., 65.
 Bazore, K., 52.
 Beach, B. A., 72.
 Beach, C. L., 9.
 Beach, F. H., 53.
 Beach, J. R., 7.
 Beach, W. S., 58.
 Beadle, A. P., 19.
 Beal, A. C., 47.
 Beal, J. M., 37.
 Beale, A. M., 28.
 Beam, A. L., 58.
 Beamer, L. C., 67.
 Bean, R. P., 69.
 Beanblossom, W. E., 19.
 Bear, F. E., 53, 54.
 Bear, K. L., 3.
 Bearer, E. V., 43.
 Beath, O. A., 73.
 Beaty, L., 3.
 Beaudette, F. R., 43.
 Beaumont, A. B., 30.
 Beaumont, J. H., 35.
 Bechdel, S. I., 58.
 Beckett, S. H., 6.
 Beckman, F. W., 22.
 Beckwith, C. S., 44.
 Beckwith, F. S., 44.
 Becraft, R. J., 65.
 Bedenbaugh, P. G., 36.
 Begg, R. E., 9.
 Beggs, A. F., 43.
 Behr, J. R., 18.
 Behre, E. H., 28.
 Behrends, F. G., 46.
 Behrens, C. A., 18.
 Bell, B., 67.
 Bell, C. E., 11.
 Bell, D. S., 53.
 Bell, F., 13.
 Bell, F. W., 23.
 Bell, J. C., 57.
 Bell, Mrs. M. C., 30.
 Bell, R. H., 58.
 Bell, R. W., 46.
 Bell, V. M., 22.
 Bellinger, C., 68.
 Belton, H. L., 6.
 Bemis, E., 33.
 Bemis, H. E., 24.
 Benbrook, E. A., 23.
 Bender, W. H., 21.
 Bendixen, H. A., 14.
 Benedict, A. A., 22.
 Benedict, M. R., 62.
 Bennett, C. W., 32.
 Bennett, D. H., 65.
 Bennett, E., 25.
 Bennett, E. R., 15.

- Bennett, F. W., 12.
 Bennett, G. L., 15.
 Bennett, J. P., 7.
 Bennewies, E. R., 62.
 Benson, F. M., 67.
 Benson, H. B., 2.
 Benson, O. K., 61.
 Bent, D. S., 65.
 Bentley, F. L., 57.
 Bentley, G. M., 63.
 Bentley, J., jr., 47.
 Bentley, M. R., 64.
 Bentley, W. D., 55.
 Benton, A. H., 51.
 Benton, J. R., 11.
 Benton, T. H., 21.
 Beresford, R., 19.
 Berg, A., 70.
 Berg, H. A., 17.
 Berg, W. E., 6.
 Berger, A., 49.
 Bergh, O. I., 36.
 Bergman, H. D., 23.
 Bergman, H. F., 13.
 Bergquist, S. G., 33.
 Berly, J. A., 61.
 Bernard, P. M., 38.
 Berridge, A. M., 34.
 Berry, J. A., 56.
 Besley, F. W., 30.
 Besse, R. S., 56.
 Bessey, E. A., 32.
 Bethke, R. M., 53.
 Betten, C., 45.
 Bewick, T. L., 72.
 Beyer, A. H., 11.
 Bias, J. H., 2.
 Bieberdorf, G. A., 55.
 Biekart, H. M., 44.
 Bierman, H., 29.
 Biester, A. M., 35.
 Biester, H. E., 23.
 Billinghamurst, R. A., 42.
 Billings, W. A., 36.
 Bilsborrow, J. D., 16.
 Bilsing, S. W., 64.
 Binney, T. H., 18.
 Binzel, C. E., 46.
 Bioletti, F. T., 6.
 Birch, H. A., 60.
 Birge, E. A., 71.
 Bishop, F. F., 64.
 Bishop, H. A., 25.
 Bissell, G. W., III, 32.
 Bisson, C. S., 5.
 Bitler, R. O., 18.
 Bittenbender, H. A., 19.
 Bivans, E. H., 30.
 Bixby, F. L., 42.
 Bizzell, J. A., 45.
 Bizzell, W. B., III, 63.
 Bjorka, K., 20.
 Black, A., 71.
 Black, A. P., 11.
 Black, C. S., 37.
 Black, J. D., 34.
 Black, L. M., 57.
 Black, M. A., 61.
 Black, W. D., 27.
 Blackiston, Mrs. P. S., 70.
 Blacklock, R. W., 11.
 Blackmon, G. H., 11.
 Blackmore, B., 47.
 Blackshear, L. E., 12.
 Blackwell, C. P., 60.
 Blair, A. W., 43.
 Blair, E. C., 49.
 Blair, G. B., 42.
 Blair, J. C., 17.
 Blair, L. W., 62.
 Blake, I. H., 28.
 Blake, M. A., 44.
 Blakely, R. W., 46.
 Blandford, J. B., 30.
 Blasingame, R. U., 58.
 Blauser, I. P., 17.
 Bledsoe, R. P., 13.
 Bleecker, W. L., 4.
 Blinn, A. M., 47.
 Blinn, P. K., 8.
 Blish, M. J., 41.
 Bliss, C. M., 45.
 Bliss, H. B., 63.
 Bliss, R. K., 19.
 Blizzard, W. L., 54.
 Blodgett, F. M., 48.
 Blodgett, M. C., 8.
 Bloodgood, D. W., 45.
 Bloye, A. I., 19.
 Blum, J. K., 64.
 Blundell, A. E., 66.
 Blundell, S. C., 66.
 Boardman, H. S., 28.
 Boatman, B., 21.
 Boatman, J. L., 21.
 Bode, I. T., 22.
 Bodman, G. B., 36.
 Boehr, J. W., 54.
 Bogart, M. T., 58.
 Bohanan, C. R., 50.
 Bohstedt, G., 53.
 Bolender, E. O., 52.
 Boles, A. P., 39.
 Bolley, H. L., 51.
 Bolton, F. C., 63.
 Bomberger, F. B., 29.
 Bonazzi, A., 54.
 Bond, G. W., 53.
 Bonde, R., 29.
 Boney, W. C., 38.
 Bonnell, J. A., 62.
 Bonnen, C. A., 17.
 Bonnet, L., 7.
 Bonslagel, C. J., 4.
 Boomer, G. R., 41.
 Booth, J. F., 46.
 Bopst, L. E., 29.
 Borgman, S. I., 33.
 Borland, A. A., 58.
 Borst, H. L., 52.
 Borthwick, H. A., 5.
 Bosque, R. E., 50.
 Boss, A., 34.
 Boss, W., 35.
 Boston, D. E., 61.
 Boswell, V. R., 30.
 Botkin, C. W., 45.
 Botsford, H. E., 48.
 Botsford, R. C., 10.
 Botteron, G. W., 62.
 Bottomley, M. E., 22.
 Boughton, I. B., 16.
 Bouquet, A. G. B., 57.
 Bourne, A. I., 31.
 Bourne, B. A., 59.
 Bourne, R. F., 8.
 Boutelle, C. A., 46.
 Bouyoucos, G. J., 33.
 Bowden, R. B., 40.
 Bowen, I. G., 43.
 Bowers, B. B., 52.
 Bowers, M. D., 30.
 Bowles, P. S., 38.
 Bowling, L. C., 28.
 Bowman, A. E., 73.
 Bowman, L. T., 4.
 Boyd, A. E., 58.
 Boyd, E. P., 54.
 Boyd, F. E., 1.
 Boyd, T. D., III, 27.
 Boyd, W. L., 36.
 Boyer, C. A., 65.
 Boyer, L. S., 68.
 Boyle, J. E., 46.
 Boys, Mrs. J. A., 47.
 Bracken, A. F., 66.
 Bracken, E., 63.
 Brackett, E. E., 41.
 Brackett, R. N., 60.
 Bradbury, D., 72.
 Bradfield, R., 39.
 Bradford, F. C., 33.
 Bradford, H. E., 41.
 Bradford, W., 12.
 Bradford, Z. B., 49.
 Bradlee, T., 66.
 Bradley, J. C., 47.
 Bradley, R. C., 48.
 Bradley, W. G., 28.
 Bradt, A. H., 41.
 Brady, M. W., 52.
 Brainard, P. P., 24.
 Braman, W. W., 59.
 Branaman, G. A., 32.
 Brandmeyer, J. D., 51.
 Brandt, I. L., 21.
 Brandt, L. M., 56.
 Brandt, P. M., 55.
 Branegan, G. A., 40.
 Brann, J. W., 72.
 Brannon, J. M., 16.
 Branson, E. B., 39.
 Branstetter, B. B., 39.
 Brant, H. J., 71.
 Braun, A. G., 72.

- Braun, R. A., 41.
 Brauner, V. J., 65.
 Brautlecht, L. M., 10.
 Bray, C. I., 7.
 Bray, Mrs. J. L., 2.
 Bray, R. H., 15.
 Brayton, H. R., 64.
 Breck, M. F., 70.
 Breed, R. S., 48.
 Breeden, E. K., 27.
 Brehm, C. E., 63.
 Brentzel, W. E., 5.
 Bressler, R. G., 58.
 Bressman, E. N., 56.
 Brett, C. E., 59.
 Brew, J. D., 46.
 Brewbaker, H. E., 34.
 Brewer, S. L., 47.
 Brewster, C. M., 68.
 Brewster, J. F., 28.
 Bridgford, R. O., 36.
 Brierley, W. G., 35.
 Briggs, G., 54.
 Briggs, G. M., 71, 72.
 Briggs, I. A., 3.
 Briggs, R. G., 1.
 Brightman, M. H., 57.
 Brink, R. A., 72.
 Brintnall, E. P., 36.
 Briscoe, C. F., 37.
 Briscoe, J. M., 29.
 Britton, W. E., 10.
 Broach, W. E., 12.
 Broadbent, F. W., 14.
 Brock, W. S., 17.
 Brockman, H., 55.
 Broderick, S. J., 31.
 Brodie, A., 14.
 Brody, S., 38.
 Broemel, A., 22.
 Brokaw, W. H., III, 41.
 Brookins, F. A., 47.
 Brooks, D. W., 12.
 Brooks, E. C., 49.
 Brooks, F. D., 18.
 Brooks, F. G., 10.
 Brooks, S. D., 38.
 Broome, F. H., 63.
 Brossard, E. B., 66.
 Broughton, L. B., 29.
 Brouse, E. M., 42.
 Brown, B. A., 9.
 Brown, B. F., 50.
 Brown, B. M., 8.
 Brown, C. L., 42.
 Brown, Carlotta M., 35.
 Brown, Clara M., 35.
 Brown, F. E., 20.
 Brown, F. J., 35.
 Brown, F. L., 55.
 Brown, G. A., 32.
 Brown, G. G., 57.
 Brown, H. D., 19.
 Brown, H. L., 11.
 Brown, H. M., 32.
 Brown, J. B., 6.
 Brown, J. G., 3.
 Brown, L., 37.
 Brown, L. A., 27.
 Brown, Mrs. L. S., 22.
 Brown, M. (N. H.), 43.
 Brown, M. (N. Dak.), 61.
 Brown, M-E., 41.
 Brown, Mrs. M. M., 63.
 Brown, O., 1.
 Brown, P. E., 21.
 Brown, P. T., 57.
 Brown, S. L., 69.
 Brown, S. M., 5.
 Brown, W. S., 57.
 Brownell, S. J., 58.
 Brownfield, W. W., 52.
 Browning, H. W., 60.
 Brubaker, H. W., 24.
 Bruce, D., 6.
 Bruce, O. C., 30.
 Bruce, W. F., 52.
 Brumley, O. V., 53.
 Brundage, A. J., 9.
 Bruner, E., 24.
 Brunner, J. J., 20.
 Bryan, A. B., 61.
 Bryan, J. D., 11.
 Bryan, K. V., 18.
 Bryan, L. W., 14.
 Bryan, O. C., 11.
 Bryan, W. E., 3.
 Bryant, T. R., 26.
 Bryant, V. C., 6.
 Bryden, C. T., 69.
 Buchanan, C., 2.
 Buchanan, D. S., 64.
 Buchanan, F. A., 67.
 Buchanan, J. H., 20.
 Buchanan, R. E., 20.
 Buchanan, W. D., 68.
 Buchanan, W. H., 61.
 Buchholz, J. T., 4.
 Buck, J. P., 63.
 Buckels, I. A., 62.
 Buckley, D. S., 9.
 Buckman, H. O., 45.
 Buckner, G. D., 26.
 Buechel, F. A., 64.
 Buehler, C. A., 63.
 Buehrer, T. F., 3.
 Buie, T. S., 60.
 Bulger, R., 6.
 Bull, M. L., 35.
 Bull, S., 16.
 Bullard, J. F., 25.
 Bullington, W. E., 63.
 Bullis, D. E., 56.
 Bullock, B. F., 50.
 Bunnell, C. E., 2.
 Burch, J. W., 38.
 Burd, J. S., 5.
 Burdick, H., 59.
 Burdick, R. T., 8.
 Burford, L. B., 17.
 Burg, A. G., 36.
 Burge, C. A., 20.
 Burger, O. F., 11.
 Burgess, P. S., 60.
 Burkart, F. L., 14.
 Burke, A. D., 54.
 Burke, E., 40.
 Burke, V., 68.
 Burkey, L. A., 68.
 Burkhart, W. C., 12.
 Burkholder, C. L., 19.
 Burkholder, W. H., 48.
 Burleigh, T. D., 12.
 Burleson, D. J., 1.
 Burleson, G. L., 27.
 Burlison, W. L., 15.
 Burnam, A., 26.
 Burnham, D. R., 45.
 Burnham, S. H., 48.
 Burnett, E. A., 41, 42.
 Burnett, J. E., 32.
 Burnett, L. C., 21.
 Burnett, W. L., 8.
 Burns, A. E., 56.
 Burns, Mrs. F. S., 35.
 Burns, F. W., 1.
 Burns, G. P., 66.
 Burns, R. H., 3.
 Burr, C. G., 67.
 Burr, W. H., 24.
 Burr, W. W., 41.
 Burrell, R. C., 52.
 Burrill, B. I., 36.
 Burritt, M. C., 45.
 Burroughs, A. M., 39.
 Burrows, J. A., 20.
 Buruss, J. A., 67.
 Burson, S., 12.
 Burt, F. A., 64.
 Burt, H., 64.
 Burt, J. H., 25.
 Busby, A. T., 38.
 Bushey, A. L., 61.
 Bushnell, J. W., 54.
 Bushnell, L. D., 24.
 Bushnell, T. M., 17.
 Busse, F. E., 21.
 Bussell, F. P., 45.
 Butcher, F. D., 23.
 Butler, G. M., 3.
 Butler, Mrs. I., 55.
 Butler, J., 52.
 Butler, J. C., 64.
 Butler, L. W., 22.
 Butler, O. R., 43.
 Butterfield, H. M., 6.
 Butterfield, K. L., 30.
 Butters, M., 44.
 Butterworth, J. E., 46.
 Button, F. C., 43, 44.
 Bux, J. H., 4.
 Buyer, E., 39.
 Byrne, C. D., 58.
 Cady, G. H., 4.
 Cady, L. C., 14.
 Cahn, E., 50.
 Caine, A. B., 20.
 Caine, G. B., 65.
 Caine, III, J. T., 65.
 Caldwell, A. B., 62.
 Caldwell, G. T., 3.

- Calhoun, F. H. H., 60.
 Call, L. E., 23.
 Callahan, E., 52.
 Calloway, C. J., 2.
 Calloway, R. C., 27.
 Calvert, S., 38.
 Calvert, W. C., 22.
 Cammack, W. A., 2.
 Camp, W. R., 6.
 Campbell, E., 12.
 Campbell, E. G., 18.
 Campbell, F. L., 44.
 Campbell, F. P., 12.
 Campbell, L. G., 44.
 Campbell, Mrs. L. H., 32.
 Campbell, M. H., 16.
 Campbell, R. B. J., 63.
 Campbell, T. M., 2.
 Campbell, W. A., 63.
 Campbell, W. W., 5.
 Canan, R. D., 18.
 Cance, A. E., 31.
 Canon, H., 47.
 Carbery, J. L., 60.
 Card, C. G., 32.
 Card, D. G., 26.
 Card, L. E., 16.
 Carder, D. S., 66.
 Cardinell, H. A., 33.
 Carlton, D. W., 64.
 Carman, G. G., 16.
 Carmichael, B. E., 29.
 Carney, S. S., 15.
 Carp, E. M., 25.
 Carpenter, C. E., 8.
 Carpenter, D. C., 48.
 Carpenter, H. V., 68.
 Carpenter, J. W., 37.
 Carpenter, O. L., 65.
 Carpenter, R. W., 29.
 Carr, R. G., 32.
 Carr, R. H., 18.
 Carrero, J. O., 59.
 Carrick, C. W., 18.
 Carrick, D. B., 47.
 Carrick, L. L., 51.
 Carrigan, J. E., 66.
 Carrington, C. C., 65.
 Carroll, G. W., 37.
 Carroll, W. E., 65.
 Carroll, W. R., 71.
 Carter, C. E., 39.
 Carter, D. G., 4.
 Carter, E. G., 65.
 Carter, G. G., 18.
 Carter, L. M., 12.
 Carter, W. T., jr., 65.
 Carver, F. E., 17.
 Carver, G. W., 2.
 Carver, J. S., 68.
 Carver, W. A., 21.
 Cary, C. A., 1, 2.
 Cary, C. E., 36.
 Case, H. C. M., 17.
 Case, L. A., 72.
 Cashen, D. J., 24.
 Caslick, E. A., 26.
 Cason, F. J., 19.
 Cassel, L. W., 68.
 Cassidy, M. H., 31.
 Castetter, E. F., 20.
 Cathcart, C. S., 44.
 Catlin, C. N., 3.
 Caton, F. B., 39.
 Cavanaugh, G. W., 46.
 Cave, H. W., 23.
 Cavert, W. L., 34.
 Chace, E. P., III, 58.
 Chadwick, D. H., 22.
 Chamberlain, F. W., 33.
 Chamberlain, J. S., 31.
 Chamberlain, R., 44.
 Chamberlin, W. J., 56.
 Chambers, C. O., 54.
 Chambers, M. J., 70.
 Chandler, F. C., 12.
 Chandler, W. H., 7.
 Chandler, W. L., 33.
 Chapman, C. C., 27.
 Chapman, C. J., 72.
 Chapman, C. W., 33.
 Chapman, C. W. L., 29.
 Chapman, G., 21.
 Chapman, I. N., 24.
 Chapman, J. E., 50.
 Chapman, N. E., 34.
 Chapman, O. W., 20.
 Chapman, P. W., 12.
 Chapman, R. N., 35.
 Chappell, V. D., 55.
 Charles, F. G., 53.
 Chase, A. R., 73.
 Cheney, L. J., 19.
 Chenoweth, W. W., 31.
 Chesnut, S. L., 1.
 Cheyney, E. G., 35.
 Chichester, P. W., 29.
 Child, A. M., 35.
 Childs, L., 57.
 Childs, R. R., 12.
 Chipman, M. E., 13.
 Chittenden, A. K., 33.
 Chittenden, D. W., 38.
 Christ, J. H., 15.
 Christensen, F. W., 51.
 Christensen, J. J., 36.
 Christensen, V. B., 66.
 Christian, C. F., 52.
 Christian, K. B., 27.
 Christie, A. W., 7.
 Christie, G. I., III, 17.
 Christopher, W. N., 40.
 Chrysler, M. A., 43.
 Chung, H. L., 14.
 Chupp, C. D., 48.
 Church, E., 51.
 Churchill, F. G., 21.
 Churchill, G. W., 48.
 Churchill, O. O., 50.
 Claassen, P. W., 47.
 Clapp, S. C., 50.
 Clark, A. J., 32.
 Clark, A. W., 49.
 Clark, B. B., 15.
 Clark, C. E., 30.
 Clark, C. M., 20.
 Clark, C. W., 3.
 Clark, D. B., 19.
 Clark, E., 44.
 Clark, F. M., 15.
 Clark, I. F., 39.
 Clark, J. H., 44.
 Clark, J. S., 28.
 Clark, K. A., 29.
 Clark, L., 14.
 Clark, L. D., 6.
 Clark, L. V., 10.
 Clark, M. G., 16.
 Clark, N. A., 20.
 Clark, O. L., 31.
 Clark, O. M., 55.
 Clark, S. P., 3.
 Clark, W. E., 42.
 Clark, W. W., 72.
 Clarke, F. R., 25.
 Clarke, W. T., 6.
 Clausen, R. E., 6.
 Clausberg, H. D., 3.
 Clayton, C. B., 66.
 Clayton, C. F., 35.
 Clayton, E. E., 48.
 Clayton, E. P., 36.
 Clayton, J. P. H., 36.
 Clayton, Mrs. B., 64.
 Clegg, W. A., 12.
 Cleland, S. B., 35.
 Clemens, L. I., 33.
 Cleveland, C. R., 18.
 Clevenger, W. L., 49.
 Cline, J. A., 39.
 Clinton, G' P., 10.
 Clutter, J. A., jr., 64.
 Clyde, A. W., 21.
 Coale, J. W., 15.
 Coates, C. E., 27.
 Cobb, A. D., 10.
 Cobb, E. M., 29.
 Cobb, F. E., 47.
 Cobb, J. S., 57.
 Cobb, W. B., 27.
 Cobleigh, W. M., 40.
 Cochran, G. W., 55.
 Cochran, R. L., 20.
 Cochrane, D. C., 59.
 Cochrane, T. J., 70.
 Cocke, R. P., 67.
 Code, W. E., 3.
 Coe, M. H., 23.
 Coen, B. F., 8.
 Coffey, J. S., 52.
 Coffey, W. C., III, 34.
 Coffin, R. G., 8.
 Coffin, R. L., 30.
 Coffman, L. D., 34.
 Coggin, W. B., 67.
 Coggins, C. L., 60.
 Colbert, F., 10.
 Colburn, F. E., 25.
 Colby, A. S., 17.
 Colclough, F. E., 12.
 Cole, F. E., jr., 31.

- Cole, H. L., 68.
 Cole, L. J., 72.
 Cole, Mrs. M. G., 51.
 Cole, W. R., 31.
 Coleman, D. H., 63.
 Coleman, I., 11.
 Coleman, J. M., 11.
 Coleman, T. A., 19.
 Coles, E. H., 25.
 Collentine, A. O., 71.
 Collings, G. F., 60.
 Collins, B., 47.
 Collins, E. V., 21.
 Collins, F. H., 14.
 Collins, H. A., 68.
 Collins, J. L., 6.
 Collins, W. O., 12.
 Collison, R. C., 48.
 Colman, H. N., 55.
 Colson, E. F., 5.
 Colver, C. W., 24.
 Colwell, R. H., 70.
 Combs, W. B., 58.
 Comish, N. H., 56.
 Compton, L. E., 18.
 Conant, G. E., 4.
 Cone, G., 33.
 Conklin, C. T., 52.
 Conn, H. J., 48.
 Connaway, J. W., 39.
 Connell, W. B., 57.
 Conner, A. B., 63.
 Conner, S. D., 18.
 Connor, M., 19.
 Connors, C. H., 44.
 Conover, J. A., 29.
 Conrad, C. M., 30.
 Conrad, J. P., 5.
 Conradi, A. F., 61.
 Conrey, G. W., 53, 54.
 Converse, B., 22.
 Converse, J. E., 62.
 Conway, W. T., 45.
 Cook, H. A., 14.
 Cook, L. E., 50.
 Cook, M. T., 59.
 Cook, W. C., 40.
 Cooke, C., 34.
 Coledge, L. H., 33.
 Cooley, E. B., 56.
 Cooley, F. S., 40.
 Cooley, R. A., 40.
 Cooley, R. B., 18.
 Coon, B. I., 41.
 Coon, R., 35.
 Coons, G. H., 32.
 Cooper, F. L., 8.
 Cooper, H. P., 45.
 Cooper, J. R., 4.
 Cooper, O. C., 54.
 Cooper, Mrs. O. L., 72.
 Cooper, T. P., III, 26.
 Coover, W. F., 20.
 Cope, R. P., 68.
 Copeland, J. T., 37.
 Copeland, L., 62.
 Copley, T. L., 67.
 Copson, G. V., 56.
 Corbett, L. S., 28.
 Corbett, R. A., 51.
 Corbin, F., 72.
 Corbould, M. K., 53.
 Cordley, A. B., 55.
 Cork, F. O., 36.
 Corkins, C. L., 73.
 Corl, J. C., 5.
 Cormany, C. E., 32.
 Cornell, F. D., jr., 70.
 Cornell, L. M., 27.
 Cornman, C. T., 67.
 Corpening, W. H., 63.
 Cory, C. L., 5.
 Cory, E. N., 29.
 Cory, V. L., 64.
 Coryell, J., 47.
 Cosby, H. E., 55.
 Cosby, S. W., 5.
 Cotner, J. B., 49.
 Cotter, R. U., 73.
 Cotterman, H. F., 29.
 Couey, W. G., 51.
 Coulter, I. P., 12.
 Coulter, J. L., 50.
 Coulter, S., 18.
 Covault, C. H., 23.
 Covell, G. A., 55.
 Covell, M. R., 28.
 Coville, P., 22.
 Covington, N. G., 2.
 Cowan, D. R., 38.
 Cowan, L., 39.
 Cowan, R. M., 33.
 Cowart, R., 36.
 Cowell, A. W., 58.
 Cowen, T. N., 2.
 Cowgill, H. J., 56.
 Cowles, H. T., 59.
 Cowles, I. F., 25.
 Cowles, M. L., 72.
 Cowles, R. B., 47.
 Cowsert, W. C., 37.
 Cox, H. R., 43.
 Cox, J. F., 32.
 Crabb, G. A., 12.
 Craft, W. A., 54.
 Craig, R. A., 19.
 Craig, V., 4.
 Craig, W. T., 45.
 Craighill, E. R., 72.
 Crain, L. D., 7.
 Cramer, A. J., 71.
 Crammond, R. G., 15.
 Crampton, G. C., 31.
 Crampton, H. G., 39.
 Crandall, B. R., 6.
 Crandall, C. S., 17.
 Crandall, F. K., 59.
 Crandall, L. B., 9.
 Crandall, W. G., 60.
 Crandall, W. T., 46.
 Crane, A. B., 69.
 Crane, A. G., 73.
 Crane, D., 70.
 Crane, F. H., 15.
 Crane, G. B., 52.
 Crane, H. L., 70.
 Cranor, K. T., 22.
 Cratty, R. I., 20.
 Crawford, C. W., 16.
 Crawford, D. L., 13.
 Crawford, I. C., 14.
 Crawford, J. C., 50.
 Crawford, R. F., 45.
 Crawford, R. P., 42.
 Cray, R. E., 52.
 Creech, B. F., 69.
 Creel, C. W., 42.
 Cresal, Mrs. I. K., 11.
 Cresswell, R. M., 32.
 Creswell, E. V., 12.
 Cresswell, M. E., 12.
 Crews, A. P., 2.
 Cribbs, W. C., 32.
 Crickman, C. W., 20.
 Crider, F. J., 3.
 Crigler, N. B., 3.
 Crim, R. F., 34.
 Crisler, O. S., 39.
 Crist, J. W., 33.
 Critz, H., 37.
 Crocheron, B. H., III, 5.
 Crockett, W. H., 66.
 Cromer, C. O., 57.
 Cromer, S. S., 18.
 Cron, A. B., 65.
 Crooks, N., III, 63.
 Crosby, C. R., 47.
 Crosby, D. J., 47.
 Cross, F., 8.
 Cross, F. B., 55.
 Crouch, C. H., 42.
 Crouch, W. E., 15.
 Crowe, L. K., 7.
 Crowley, D. J., 69.
 Croy, O. C., 52.
 Crozier, W. J., 44.
 Cruess, W. V., 7.
 Crum, L. V., 22.
 Crumley, J. J., 54.
 Crutcher, B. H., 11.
 Crutchfield, C. L., 14.
 Culbertson, C. C., 20.
 Culbertson, J. L., 68.
 Cullinan, F. P., 19.
 Cummings, M. B., 66.
 Cummins, A. B., 6.
 Cundy, A. T., 73.
 Cunningham, Mrs. A. P., 67.
 Cunningham, C. C., 18.
 Cunningham, G. V., 12.
 Cunningham, J. C., 22.
 Cunningham, O. C., 45.
 Cunningham, W. S., 3.
 Cureton, M. L., 1.
 Curie, I. H., 54.
 Currence, T. M., 70.
 Currier, E. L., 40.
 Currin, H. R., 46.
 Currin, R. E., 61.
 Currin, R. E., jr., 50.
 Curry, A. S., 45.

- Curtis, A. W., 70.
 Curtis, H. E., 27.
 Curtis, O. F., 46.
 Curtis, P. B., 18.
 Curtis, R. S., 49.
 Curtis, R. W., 47.
 Curtis, W. C., 39.
 Curtiss, C. F., 19.
 Curtiss, J. W., 8.
 Cushman, C. G., 60.
 Cushman, H. E., 40.
 Cutler, J. S., 52.
 Cutright, C. R., 53.
- Daane, A., 54.
 Dadisman, A. J., 70.
 Dadisman, S. H., 73.
 Dahl, A. von B., 13.
 Dahl, H. E., 58.
 Dahlberg, A. C., 48.
 Dahlberg, I. T., 47.
 Dahle, C. D., 34.
 Dahnke, M., 63.
 Dakan, E. L., 52.
 Dakin, M. E., 9.
 Dalbey, N. E., 24.
 Dale, C. S., 17.
 Dalrymple, G. B., 31.
 Dalrymple, W. H., 28.
 Dalton, L. A., 45.
 Damel, J. W., 39.
 Damon, S. C., 59.
 Dana, B. F., 69.
 Dancy, C. E., 66.
 Danforth, R. E., 59.
 Daniels, H. E., 61.
 Darlington, H. T., 32.
 Darlow, A. E., 54.
 Darnell, A. L., 64.
 Darrow, W. H., 9.
 Darst, W. H., 49.
 Daugherty, M. M., 64.
 Davenport, F. S., 24.
 Davidson, A. P., 24.
 Davidson, F. A., 16.
 Davidson, J. B., 21.
 Davidson, S. F., 49.
 Davis, A. R., 5.
 Davis, C. C., 61.
 Davis, C. D., 23.
 Davis, D. E., 7.
 Davis, E., 55.
 Davis, E. C., 28.
 Davis, E. G., 47.
 Davis, F., 6.
 Davis, G. E., 22.
 Davis, H. L., 56.
 Davis, H. P., 41.
 Davis, I. G., 9.
 Davis, I. P., 61.
 Davis, J. J., 18.
 Davis, J. W., 70.
 Davis, L. E., 50.
 Davis, L. V., 12.
 Davis, Mrs. M. M., 67.
 Davis, P. O., 2.
 Davis, R., 73.
- Davis, R. J., 68.
 Davis, R. L., 59.
 Davis, R. N., 3.
 Davis, W., 37.
 Davis, W. A., 49.
 Davis, W. E., 24.
 Davis, W. H., 31.
 Davis, W. J., 13.
 Davison, E., 22.
 Davison, F. R., 34.
 Day, A. M., 73.
 Day, E. J., 58.
 Day, F. D., 29.
 Day, J. W., 11.
 Day, L. H., 7.
 Day, O., 47.
 Day, R. T., 22.
 Dean, A. L. (Hawaii), 13.
 Dean, A. L. (Va.), 67.
 Dean, F. W., 54.
 Dean, G. A., 24.
 Dean, H. K., 57.
 Dean, J. M., 37.
 Dearing, C., 50.
 Dearstyne, R. S., 49.
 Deatrick, E. P., 70.
 Deats, M. E., 60.
 DeBaun, R. W., 44.
 DeBord, G. G., 20.
 DeBusk, E. F., 11.
 DeCamp, J. C., 53.
 Decker, J. L., 6.
 Deen, E. E., 37.
 Deering, A. L., 29.
 DeGroft, G. M., 54.
 Dellinger, S. C., 4.
 DeLong, D. M., 53.
 DeLong, G., 51.
 del Valle, M. A., 59.
 Delwiche, E. J., 71, 72.
 Demarest, W. H. S., 43.
 Demeritt, D. B., 29.
 Dennis, F. H., 45.
 Dennis, W. V., 58.
 Denny, J. A., 5.
 Denson, W. P., 27.
 Dent, B. R., 61.
 Dent, J. G., 35.
 de Ong, E. R., 6.
 DePew, H. F., 42.
 Derbigney, I. A., 68.
 de Regt, A. C., 43.
 Derieux, J. B., 50.
 De Rose, H. R., 24.
 Derrick, J. W., 13.
 Derrick, W. W., 41.
 Detjen, L. R., 10.
 Detmers, F., 53.
 DeTurk, E. E., 15.
 Devan, T. A., 44.
 DeVault, S. H., 30.
 Dewar, E. S., 49.
 Dexter, J., 40.
 DeYoung, W., 39.
 de Zeeuw, R., 32.
 Diaz, M. R., 69.
- Dice, J. R., 51.
 Dickens, A., 25.
 Dickerson, H. G., 65.
 Dickey, J. A., 46.
 Dickey, J. B. R., 57.
 Dickinson, S., 35.
 Dickson, J. G., 72.
 Dickson, R. E., 65.
 Didlake, M. LeG., 26.
 Diehl, M., 55.
 Dietrick, L. B., 67.
 Dietz, C. L., 39.
 Diggs, C. H., 22.
 Dike, C. E., 53.
 Dikmans, G., 35.
 Dillingham, F. T., 13.
 Dillon, Mrs. N. B., 65.
 Dills, L. E., 23.
 Dimock, W. W., 26.
 Dixon, A. A., 50.
 Dixon, B., 8.
 Dobbins, R. A., 52.
 Dobbs, E. C., 2.
 Dobbs, J. S., 25.
 Dodd, D. R., 69.
 Dodge, B. F., 72.
 Dodge, R. E., 9.
 Dodson, E. M., 6.
 Dodson, W. R., 27, 28.
 Doehert, C. A., 44.
 Doermann, M. C., 44.
 Dole, E. J., 66.
 Dolve, M. A., 62.
 Donald, J. S., 71.
 Donham, C. R., 57.
 Donnell, O. G., 50.
 Donnelly, A. M., 52.
 Door, J. M., 26.
 Doran, E. B., 28.
 Doran, W. L., 31.
 Dorchester, C. S., 21.
 Dore, W. H., 5.
 Dorney, H. B., 17.
 Dorsey, E., 45.
 Dorsey, H., 9.
 Dorsey, L. M., 28.
 Dorsey, M. J., 70.
 Doten, S. D., 42.
 Doty, H. E., 54.
 Dougherty, J. E., 5.
 Douglass, E., 8.
 Dow, B. K., 9.
 Dowdell, D. M., jr., 37.
 Dowdle, L. P., 12.
 Dowdy, G., 52.
 Dowell, A. A., 34.
 Dowell, C. T., 54.
 Dowell, S., 1.
 Down, E. E., 32.
 Downey, U. J., 51.
 Downing, P., 29.
 Downs, P. A., 41.
 Doxsee, E. D., 3.
 Doyle, L. P., 19.
 Dozier, C. C., 66.
 Dozier, M. L., 58.
 Drain, B. D., 31.

- Drain, H. D., 52.
 Drake, C. J., 23.
 Drake, E. T., 51.
 Drake, V., 25.
 Draper, F. G., 20.
 Dreesen, W. H., 56.
 Drew, J. M., 35.
 Driftmier, R. H., 24.
 Drinkard, A. W., jr., 67.
 Drollinger, P. H., 18.
 Dubbert, F. K., 21.
 Dubbs, M., 25.
 DuBois, R., 55.
 Dudley, J. B., 50.
 Duecker, W. W., 20.
 Duffee, F. W., 71.
 Duggar, J. F., 1, 5.
 Dukes, H. H., 23.
 Duley, F. L., 39.
 Dunbar, B. A., 61.
 Duncan, H. R., 62.
 Duncan, J. R., 32.
 Duncan, L. N., 1.
 Duncan, W. O., 20.
 Duncombe, E., 18.
 Dunford, C. S., 32.
 Dunham, R. S., 36.
 Dunkle, P. B., 65.
 Dunlap, T. E., 59.
 Dunn, L. C., 9.
 Dunn, P. L., 47.
 Dunnam, E. W., 28.
 Dunning, F., 41.
 Dunshee, C. F., 6.
 Durant, A. J., 39.
 DuRant, A. L., 60.
 Durham, B., 28.
 Durham, H., 25.
 Durrell, L. W., 20.
 Duruz, W. P., 7.
 Durward, M. E., 8.
 DuSault, D. D., 14.
 Dutcher, R. A., 58.
 Dutton, W. C., 33.
 Dvorachek, H. E., 4.
 Dworak, M., 51.
 Dye, M., 33.
 Dyer, W. P., 35.
 Dykstra, R. R., 25.
 Dynes, O. W., 62.

 Eames, A. J., 46.
 Earle, S. B., 60.
 Easley, M., 41.
 Easson, R. B., 5.
 Easter, E. C., 1.
 Eastman, M. G., 42.
 Eastwood, G. R., 52.
 Eaton, F. M., 36.
 Eaton, H. F., 73.
 Eaton, T. H., 46.
 Eaton, W. H., 1.
 Ebersole, A., 63.
 Ebling, W. H., 72.
 Eckert, J. E., 50.
 Eckles, C. H., 34.
 Eddy, C. O., 61.

 Eddy, G. C., 8.
 Eddy, H. G., 6.
 Eddy, J., 1.
 Edgerton, C. W., 27.
 Edgington, B. H., 53.
 Edlefsen, N. E., 66.
 Edmonds, J. L., 16.
 Edmondson, C. H., 13.
 Edmondson, R. A., 11.
 Edmonson, E., 9.
 Edson, E. O., 64.
 Edwards, A. L., 60.
 Edwards, C. W., 13.
 Edwards, F. M., 57.
 Edwards, H., 59.
 Edwards, L. F., 53.
 Edwards, L. S., 62.
 Edwards, W. E. J., 32.
 Edwards, W. G., 58.
 Efferson, H. M., 11.
 Eichelberger, M., 27.
 Eilert, M. A., 22.
 Einset, O., 49.
 Elder, C., 73.
 Elder, M., 22.
 Eldred, Mrs. F. A., 37.
 Eldredge, B. R., 65.
 Eldredge, J. C., 21.
 Eldridge, A. S., 18.
 Elevehjem, C. A., 71.
 Ellenberger, H. B., 66.
 Ellenwood, C. W., 54.
 Ellett, W. B., 67.
 Elling, C. G., 23.
 Ellington, E. V., 68.
 Elliott, E. C., 17.
 Elliott, J., 63.
 Elliott, J. W., 59.
 Elliott, M., 69.
 Elliott, N. R., 26.
 Ellis, B. W., 9.
 Ellis, O. I., 15.
 Elrod, J. M., 12.
 Elser, W. L., 45.
 Elwood, C. F., 6.
 Elwood, P. H., jr., 22.
 Ely, A. G., 44.
 Ely, F., 20.
 Emberson, R. H., 38.
 Embleton, H., 3.
 Embody, G. C., 47.
 Emerson, A. J., 73.
 Emerson, D., 29.
 Emerson, P., 21.
 Emerson, R. A., 45.
 Emery, F. E., 25.
 Emery, H. M., 43.
 Emmerich, L. P., 67.
 Ende, C. L. von, 14.
 Enders, H. E., 18.
 Engbretson, A. E., 57.
 English, L., 45.
 English, P. F., 64.
 Englund, E., 24.
 Enright, E. M., 27.
 Epple, W. F., 18.
 Eppley, G. F., 29.

 Erb, E. S., 58.
 Erdman, H. E., 6.
 Erdman, L. W., 21.
 Erf, O., 52.
 Erickson, E. T., 21.
 Erickson, T. A., 35.
 Eriksen, S., 39.
 Erwin, A. T., 22.
 Essary, S. H., 62.
 Essig, E. O., 6.
 Esten, W. M., 9.
 Estill, H. W., 3.
 Estill, M. H., 3.
 Eswine, H. E., 52.
 Etheridge, R. B., 49.
 Etheridge, W. C., 39.
 Eubank, M. E., 70.
 Evans, A. T., 61.
 Evans, B. V., 37.
 Evans, E. B., 65.
 Evans, M., 24.
 Evans, P. N., 18.
 Evans, R. J., 65.
 Evans, R. W., 58.
 Evans, S. C., 64.
 Evans, S. W., 61.
 Everett, G. A., 47.
 Everhardy, L. H., 25.
 Evvard, J. M., 20.
 Ewell, E., 32.
 Ewing, D. T., 32.
 Eyster, W. H., 38.

 Fabian, F. W., 33.
 Fagan, F. N., 58.
 Fager, G. E., 17.
 Fair, J. R., 12.
 Fairbank, J. P., 6.
 Fairbanks, B. W., 7.
 Fairbanks, F. L., 46.
 Fairchild, L. H., 18.
 Falconer, J. I., 52.
 Fallgatter, F., 40.
 Faneuf, L. J., 44.
 Fant, G. W., 49.
 Fargo, J. M., 71.
 Farley, A. J., 44.
 Farley, D. C., 62.
 Farley, G. L., 31.
 Farmer, L. A., 47.
 Farnham, F. R., 49.
 Farquharson, J., 8.
 Farr, J. L., 27.
 Farrand, L., 45.
 Farrell, A. W., 5.
 Farrell, F. D., III, 23.
 Farrell, H., 65.
 Farrington, E. H., 71.
 Fasten, N., 57.
 Fatout, P. L., 57.
 Faulkner, J. G., 62.
 Faurot, F. W., 39.
 Faust, F., 22.
 Faust, H., 7.
 Fawcett, C. J., 30.
 Fawcett, H. S., 7.
 Fay, A. C., 24.

- Fecht, E. F., 25.
 Fedde, M. S., 41.
 Feeley, R. O., 61.
 Feldman, W. H., 8.
 Felker, C. A., 65.
 Feltner, J. M., 26.
 Felton, R. A., 46.
 Felts, R. H., 8.
 Fenner, L. M., 48.
 Fenton, F., 47.
 Fenton, F. A., 23.
 Fenton, F. C., 21.
 Fergus, E. N., 26.
 Ferguson, C. M., 32.
 Ferguson, H. C., 37.
 Ferguson, J. A., 58.
 Ferguson, O. J., 41.
 Fernald, E. I., 46.
 Fernald, H. T., 31.
 Ferrin, E. F., 34.
 Ferris, C. E., 62.
 Ferris, E. B., 37.
 Ferriss, E. N., 46.
 Ferry, E. S., 19.
 Fetrow, W. W., 71.
 Field, A. M., 35.
 Field, H. G., 66.
 Filley, H. C., 41.
 Filley, W. O., 10.
 Findley, J., 53.
 Finlayson, H. C., 51.
 Finley, C. B., 20.
 Finley, L. M., 25.
 Finnell, H. H., 54.
 Firkins, B. J., 21.
 Firor, G. H., 12.
 Fish, E. E., 26.
 Fish, F. H., 64.
 Fish, N. S., 71.
 Fisher, H. J. (Conn.), 9, 10.
 Fisher, H. J. (Minn.), 35.
 Fisher, M. C., 22.
 Fisher, M. J., 48.
 Fisher, M. L., 17.
 Fisher, R. C., 9.
 Fisher, W. I., 45.
 Fisk, W. W., 46.
 Fiske, F. C., 66.
 Fiske, J. G., 44.
 Fitch, C. L., 22.
 Fitch, C. P., 36.
 Fitch, F. W., 12.
 Fitch, J. B., 23.
 Fitch, L. E., 12.
 Fitch, W. Q., 19.
 Fite, A. B., 45.
 Fitschen, F., 27.
 Fitterer, J. C., 73.
 Fitting, H. W., 18.
 Fitts, E. B., 58.
 Fitts, P. I., 42.
 Fitzgerald, M., 55.
 Fitzgerald, N., 27.
 Fitzgerald, N. E., 63.
 Fitzpatrick, H. M., 48.
 Fix, A. A., 59.
 Flanery, C. C., 62.
 Flaningham, N. K., 19.
 Flansburgh, E. A., 47.
 Fleenor, B. H., 24.
 Fleming, C. E., 42.
 Fleming, J., 53.
 Fletcher, L. J., 6.
 Fletcher, R. K., 64.
 Fletcher, S. W., 58.
 Flint, C. L., 7.
 Flint, O. S., 30.
 Flor, H. H., 36.
 Flora, E., 56.
 Flowers, L. I., 68.
 Floyd, E. M., 3.
 Floyd, W. L., 11.
 Fluharty, L. W., 6.
 Fluke, C. L., jr., 71.
 Fogg, H. C., 43.
 Fogle, F. E., 33.
 Fogle, Mrs. J. R., 33.
 Felger, A. H., 5.
 Folsom, D., 29.
 Foord, J. A., 31.
 Forbes, D., 14.
 Forbes, E. B., 59.
 Forbes, W. T. M., 47.
 Ford, A. L., 62.
 Ford, C., 17.
 Ford, M., 70.
 Ford, O. W., 18.
 Foreman, E. C., 32.
 Foresman, G. K., 18.
 Forman, L. W., 21.
 Forrest, E., 40.
 Forster, G. W., 50.
 Foss, P. E., 31.
 Foster, J. D., 26.
 Foster, Mrs. L. M., 42.
 Foster, M. E., 22.
 Foster, M. T., 38.
 Foster, R. G., 42.
 Foster, R. L., 4.
 Foster, W. A., 12.
 Foulkrod, G. M., 58.
 Foust, H. L., 51.
 Fowlds, M., 61.
 Fox, C. E., 58.
 Fox, F. E., 55.
 Fox, H. D., 41.
 Frame, B. H., 38.
 Frame, N. T., 69.
 Francioni, J. B., 27.
 Francis, E., 58.
 Francis, M., 65.
 Frandsen, P., 42.
 Frank, A., 69.
 Franklin, H. J., 31.
 Fraps, G. S., 64.
 Fraser, A. C., 45.
 Fraser, W. J., 16.
 Frazier, D. M., 55.
 Frazier, J. S., 13.
 Frazier, R., 11.
 Frazier, W. C., 71.
 Frear, D. W., 39.
 Fred, E. B., 71.
 Frederick, H. J., 66.
 Freeborn, S. B., 6.
 Freeman, B., 60.
 Freeman, B. W., 37.
 Freeman, E. M., 34.
 Freeman, J. F., 26.
 Freeman, V. A., 32.
 Freeman, W. R., 8.
 Freestrom, S., 52.
 French, A. P., 31.
 French, F. E., 45.
 French, Mrs. M. H., 44.
 French, R. B., 59.
 Friant, R. J., 22.
 Frick, E. J., 25.
 Friend, R. B., 10.
 Friend, W. H., 65.
 Frier, G. M., 19.
 Fries, J. A., 59.
 Frisbie, L. I., 41.
 Fristoe, H. W., 37.
 Fritts, T. A., 4.
 Fritz, E., 6.
 Frodsham, J., 39.
 Fromme, F. D., 67.
 Frost, H. B., 7.
 Frost, S. W., 58.
 Frost, W. D., 71.
 Frost, W. S., 43.
 Fudge, B. R., 44.
 Fugimoto, G., 13.
 Fuhr, A. H., 55.
 Fuller, E. A., 66.
 Fuller, F. D., 64.
 Fuller, J. G., 71.
 Fuller, J. M., 42.
 Fuller, O. M., 51.
 Fulmer, E. I., 20.
 Fulton, B. B., 56.
 Funchess, M. J., 1.
 Funk, L. C., 20.
 Futrall, J. C., 4.
 Gabbard, L. P., 64.
 Gabrielson, M. L., 22.
 Gaddis, L. R., 19.
 Gaessler, W. G., 20.
 Gage, G. E., 31.
 Gail, F. W., 14.
 Gaines, E. F., 69.
 Gaines, J. G., 43.
 Gaines, N. W., 41.
 Gaines, W. L., 16.
 Gainey, P. L., 24.
 Gallagher, H. J., 33.
 Galloway, M., 4.
 Galloway, J. C., 20.
 Galloway, Z. L., 26.
 Gallup, W. D., 55.
 Gamble, J. A., 29.
 Gamble, M. E., 19.
 Gandy, J. M., 68.
 Gannon, A. F., 12.
 Gannon, E. A., 18.
 Garber, R. J., 69.
 Garcia, F., 45.
 Gard, N. A., 27.

- Gardner, A. K., 28.
 Gardner, F. D., 57.
 Gardner, G. R., 68.
 Gardner, J. S., 27.
 Gardner, L. P., 28
 Gardner, M. B., 22.
 Gardner, M. N., 47.
 Gardner, M. W., 18.
 Gardner, V. R., 33.
 Gardner, W., 66.
 Gardner, W. A., 1.
 Garey, L. F., 34.
 Garlock, F. L., 21.
 Garlock, H. M., 38.
 Garman, H., 26.
 Garman, F., 10.
 Garnett, W. E., 64.
 Garren, G. M., 49.
 Garrett, V. L., 69.
 Garrigus, H. L., 9.
 Garrison, E. P., 33.
 Garside, M. S., 26.
 Garvey, M. E. M., 31.
 Garvin, A. L., 53.
 Gaskill, E. F., 30.
 Gasser, G. W., 3.
 Gatchell, D., 1.
 Gates, C. E., 16.
 Gates, F. C., 24.
 Gates, W. H., 28.
 Gault, L., 27.
 Gaumnitz, E. W., 35.
 Gay, C. W., 52.
 Gay, M. C., 12
 Gaylord, F. C., 19.
 Gearhart, C. R., 58.
 Gee, E. A., 32.
 Geib, H. V., 63.
 Geib, W. J., 72.
 Geiger, B. J., 8.
 Geise, F. W., 30.
 Gelbach, R. W., 68.
 Gemmell, G. A., 24.
 Gentner, L. G., 32.
 Gentry, C. B., 9.
 George, G. D., 36.
 George, L. R., 19.
 Georgeson, C. C., 3.
 Georgia, Mrs. L., 47.
 Gerhardt, F., 20.
 Gericke, W. F., 5.
 Gerlaugh, P., 52.
 Gershoy, A., 66.
 Getman, G. S., 33.
 Gettemy, W. S., 33.
 Getty, R. E., 25.
 Gibbons, G. C., 54.
 Gibbs, W. M., 14.
 Gibson, A. W., 45.
 Gibson, E., 22.
 Gibson, H. H., 56.
 Gibson, I. G., 38.
 Gibson, J. M., 15.
 Giddings, M. L., 17.
 Giddings, N. J., 70.
 Giesecker, L. F., 40.
 Giesen, Mrs. M. B., 27.
 Gifford, F. H., 72.
 Gifford, W., 70.
 Gilbert, A. H., 66.
 Gilbert, E. M., 72.
 Gilbert, H. C., 36.
 Gilbertson, G. I., 62.
 Gilchrist, D. A., 3.
 Gilcreast, R. M., 62.
 Gildow, E. M., 72.
 Giles, J. K., 12.
 Gilkey, H. M., 56.
 Gillette, C. P., 7.
 Gillis, M. C., 45.
 Gillison, B., 61.
 Gilman, H., 20.
 Gilman, J. C., 20.
 Gilmer, P. M., 35.
 Gilmore, J. W., 5.
 Gilmore, W. J., 56.
 Giltner, W., 33.
 Ginsberg, J. M., 44.
 Gladwin, F. E., 49.
 Glanton, L. P., 24.
 Glasgow, H., 49.
 Glatfelter, G. V., 30.
 Gleason, E. G., 47.
 Gleason, F., 11.
 Glenn, M. A., 2.
 Glick, H. N., 31.
 Glines, N. W., 53.
 Glover, A. C., 15.
 Glover, G. H., 8.
 Gloyer, W. O., 48.
 Gobble, C. F., 18.
 Godbey, E. G., 60.
 Goddard, R. W., 45.
 Godfrey, R., 39.
 Godkins, J., 67.
 Goeder, F. P., 8.
 Goff, R. A., 14.
 Goldstein, H., 35.
 Goldstein, V., 35.
 Goldthwaite, N. E., 8.
 Gooch, M. E., 28.
 Good, E. S., 26.
 Good, H. G., 47.
 Goodale, B. E., 60.
 Gooding, T. H., 41.
 Goodell, C. J., 37.
 Goodling, C. L., 58.
 Goodman, A. M., 46.
 Goodwin, G. W., 2.
 Gardner, L. G., 19.
 Gordon, A. H., 61.
 Gordon, C. E., 31.
 Gordon, C. H., 63.
 Gordon, E., 63.
 Gordon, N. E., 29.
 Gordon, W. R., 58.
 Gorman, N. D., 51.
 Gortner, R. A., 34.
 Gorzycki, C. J., 65.
 Goss, E. F., 20.
 Goss, H., 7.
 Goss, L. W., 53.
 Goss, R. B., 18.
 Goss, R. W., 41.
 Goss, W. G., 18.
 Gossard, H. A., 53.
 Gott, E. J., 27.
 Gottschalck, C. A., 51.
 Gould, O. J., 23.
 Gourley, J. H., 54.
 Gowen, J. W., 28.
 Graber, L. F., 71.
 Graff, Mrs. E. F., 22.
 Graham, J. C., 30.
 Graham, K. H., 11.
 Graham, R., 16.
 Graham, R. E., 58.
 Graham, S. A., 35.
 Graham, V., 64.
 Gramelspacher, C. U., 17.
 Gramlich, H. J., 41.
 Grams, W. T., 46.
 Granovsky, A. A., 71.
 Grant, Mrs. A. L., 46.
 Grant, E. A., 2.
 Grant, G. A., 58.
 Grantham, G. M., 33.
 Gratz, L. O., 11.
 Graul, E. J., 72.
 Gravitt, W. T., 2.
 Gray, D. M., 57.
 Gray, D. S., 21.
 Gray, D. T., (Ark.) 4.
 Gray, D. T. (W. Va.), 70.
 Gray, E. R., 17.
 Gray, F. G., 3.
 Gray, G. F., 10.
 Gray, J., 11.
 Gray, J. M., 50
 Gray, R. B., 15.
 Graybeal, H. C., 63.
 Greaves, J. E., 65.
 Green, E. L., 68.
 Green, F. L., 2.
 Green, G. R., 58.
 Green, H. S., 31.
 Green, R. M., 24.
 Green, T. C., 54.
 Green, W. J., 54.
 Green, W. W., 67.
 Greenbank, W. K., 54.
 Greene, F. M., 8.
 Greene, J. G., 41.
 Greene, L., 19.
 Greene, M., 14.
 Greene, P. S., 29.
 Greene, S. S., 37.
 Greene, S. W., 37.
 Gregg, J. W., 7.
 Gregory, C. T., 18.
 Gregory, H. W., 18.
 Grettenberger, M. L., 32.
 Griebel, Mrs. C. H., 44.
 Griffee, F., 34.
 Griffin, F. L. (Calif.), 6.
 Griffin, F. L. (Mont.), 40.
 Griffin, L., 4.
 Griffith, J. P., 59.
 Grimes, J. C., 1.

- Grimes, M. F., 57.
 Grimes, W. E., 24.
 Grindley, H. S., 16.
 Grinnells, C. D., 61.
 Griswold, D. J., jr., 51.
 Griswold, G. H., 47.
 Gromer, S. D., 38.
 Gromme, H., 53.
 Grose, L. R., 31.
 Gross, D. L., 41.
 Gross, E. R., 43.
 Gross, I. H., 33.
 Gross, L. G., 48.
 Grossley, H. B., 10.
 Grossley, R. S., 10.
 Grossman, J. D., 53.
 Groth, A. H., 64.
 Grout, G. P., 64.
 Grover, E. L., 32.
 Guard, W. F., 23.
 Guba, E. F., 48.
 Guerrero, F. B. L., 13.
 Guerrero, J., 13.
 Guilbert, H. R., 23.
 Guise, C. H., 47.
 Gullickson, T. W., 34.
 Gumbart, E. H., 9.
 Gumble, K., 10.
 Gunderson, L. E., 42.
 Guinness, C. I., 31.
 Gunns, C. A., 25.
 Gunson, T., 33.
 Gurst, L. J., 28.
 Gustafson, A. F., 45.
 Guthrie, D. V., 28.
 Guthrie, E. S., 46.
 Guthrie, J. E., 23.
 Guthrie, M. L., 63.
 Guyton, F. E., 2.

 Haag, J. R., 34.
 Haas, A. J., 71, 72.
 Haas, A. R., C., 5.
 Haber, E. S., 22.
 Haber, Mrs. J. M., 46.
 Haber, V. R., 47.
 Hackedorn, H., 68.
 Hackleman, J. C., 15.
 Haddon, C. B., 28.
 Hadley, E. E., 55.
 Hadley, F. B., 72.
 Hadwen, S., 66.
 Haedecke, A., 34.
 Haenseler, C. M., 44.
 Hafner, V. E., 65.
 Hagerty, M. I., 72.
 Hague, F. S., 57.
 Haig, F. M., 49.
 Haigh, L. D., 38.
 Hale, H., 4.
 Hale, W., 72.
 Hale, W. J., 63.
 Haley, D. E., 58.
 Hall, A. R., 38.
 Hall, E. W., 62.
 Hall, F. A., 44.
 Hall, F. H., 49.
 Hall, G. O., 48.
 Hall, H. E., 13.
 Hall, H. F., 16.
 Hall, H. W., 28.
 Hall, I. F., 46.
 Hall, M., 22.
 Hall, M. L., 19.
 Hall, M. V., 9.
 Hall, N., 39.
 Hall, O. F., 19.
 Hall, S. W., 17.
 Hall, T. R., 69.
 Hall, W. J., 40.
 Haller, F. W., 58.
 Halligan, C. P., 33.
 Hallman, E. T., 33.
 Hallstedt, A. L., 25.
 Halm, H. H., 41.
 Halma, F. F., 5.
 Halpin, J. G., 71.
 Halversen, W. V., 56.
 Halverson, J. O., 49.
 Hamblin, A. P., 70.
 Hamiel, G. R., 45.
 Hamilton, A. G., 27.
 Hamilton, C. C., 29.
 Hamilton, D. W., 68.
 Hamilton, H. G., 11.
 Hamilton, J. M., 40.
 Hamilton, J. O., 25.
 Hamilton, R. W., 60.
 Hamilton, T. S., 16.
 Hamlin, H. M., 21.
 Hamlin, M., 31.
 Hammans, C. W., 21.
 Hammer, B. W., 20.
 Hammer, J. G., 20.
 Hammond, L. K., 42.
 Hammond, R. E., 33.
 Hammond, W. E., 20.
 Hand, W. F., 37.
 Hanger, W. E., 52.
 Hannah, J. A., 32.
 Hannas, R. R., 44.
 Hansen, A. A., 18.
 Hansen, D., 40.
 Hansen, E., 66.
 Hansen, J. M., 21.
 Hansen, L. S., 53.
 Hansen, N. E., 62.
 Hansen, T. S., 36.
 Hanson, E. A., 34.
 Hanson, F. P., 17.
 Hansson, F., 14.
 Haralson, F., 36.
 Harbaugh, A. E., 13.
 Harden, T. D., 63.
 Hardenburg, E. V., 47.
 Hardie, W., 1.
 Hardies, E. W., 61.
 Hardman, G., 42.
 Hare, C. L., 1.
 Harford, R. M., 34.
 Haring, C. M., 5.
 Harkey, F. L., 60.
 Harlan, J. D., 48.
 Harlan, M. L., 19.
 Harland, M. B., 15.
 Harling, Mrs. E. P., 23.
 Harman, J. H., 32.
 Harman, M. T., 25.
 Harman, S. W., 49.
 Harmer, P. M., 33.
 Harmon, E. M., 38.
 Harmon, K. G., 39.
 Harms, A. H., 26.
 Harnden, E. E., 55.
 Harned, H. H., 37.
 Harned, R. W., 37.
 Harper, C., 18.
 Harper, C. H., 63.
 Harper, E. H., 64.
 Harper, F., 48.
 Harper, H. J., 21.
 Harper, M. W., 46.
 Harper, W. L., 21.
 Harrah, E. C., 73.
 Harrington, E. A., 31.
 Harrington, F. M., 40.
 Harrington, H. L., 12.
 Harrington, Mrs. I. S., 44.
 Harris, A. E., III, 1.
 Harris, C. E., 26.
 Harris, J. A., 50.
 Harris, M. H., 66.
 Harris, R. D., 31.
 Harris, R. J., 49.
 Harris, R. T., 71.
 Harris, W. G., 67.
 Harris, W. J., 26.
 Harrison, A. K., 31.
 Harrison, B. M., 23.
 Harrison, F., 69.
 Harrison, T. B., 62.
 Harriss, S. M., 24.
 Harshaw, H. M., 38.
 Hart, E. B., 71.
 Hart, G. H., 7.
 Hart, J. C., 13.
 Hart, O. P., 37.
 Hart, P. H., 50.
 Hart, V. B., 46.
 Harter, E. L., 64.
 Harter, W. L., 21.
 Hartley, C. H., 70.
 Hartman, C., jr., 7.
 Hartman, G., 73.
 Hartman, H., 57.
 Hartman, L. W., 42.
 Hartman, S. C., 54.
 Hartnett, E. E., 62.
 Hartsell, F. Z., 49.
 Hartsuch, B. E., 32.
 Hartwell, B. L., III, 59.
 Harvey, A. L., 34.
 Harvey, E. M., 57.
 Harvey, H. W., 12.
 Harvey, R. B., 36.
 Harvey, S. H., 29.
 Harwood, N. D., 25.
 Hasbrouck, P. B., 31.
 Haseman, L., 38.
 Haskell, S. B., 30.
 Haskins, H. D., 31.

- Haslerud, E. J., 40.
 Hasselman, J. B., 32.
 Hastings, E. G., 71.
 Haston, C., 54.
 Haswell, J. R., 58.
 Hatch, K. L., 71, 72.
 Hathaway, C. L., 26.
 Hathcock, J. S., 44.
 Hauge, S. M., 18.
 Haugh, M. B., 17.
 Hauser, M. A., 21.
 Hausman, L. A., 44.
 Hauter, L. H., 45.
 Havenhill, M., 24.
 Havner, H. H., 57.
 Haw, J. W., 51.
 Hawker, H. W., 65.
 Hawkins, B. M., 39.
 Hawkins, R. S., 3.
 Hawks, J. W., 20.
 Hawley, I. M., 66.
 Hawley, R. D., 31.
 Hawthorn, H. B., 21.
 Hayden, A., 20.
 Hayden, C. C., 53.
 Hayes, F. M., 7.
 Hayes, G., 11.
 Hayes, H. K., 34.
 Hayes, J. B., 71.
 Hayes, W. P., 24.
 Hayes, W. W., 2.
 Haymaker, H. H., 24.
 Haynes, C. D., 61.
 Haynes, E., 71.
 Hays, F. A., 30.
 Hays, J. G., 32.
 Hays, W. P., 38.
 Hays, W. V., 49.
 Haywood, W. G., 49.
 Hazeltime, D. M., 24.
 Hazen, L. E., 55.
 Hazen, W., 60.
 Headden, W. P., 8.
 Headlee, T. J., 44.
 Heald, F. D., 69.
 Healy, D. J., 26.
 Hean, C. S., 72.
 Hearne, C. C., 38.
 Heaton, V. E., 22.
 Heck, A. F., 69.
 Heck, C. M., 50.
 Hecker, H., 36.
 Heckert, L. C., 20.
 Hedges, C. C., 64.
 Hedrick, U. P., 49.
 Hedrick, W. O., 32.
 Heebink, G., 61.
 Hegnauer, L., 69.
 Heifner, L. E., 20.
 Heim, R. W., 10.
 Helmlich, L. F., 18.
 Hein, M. A., 15.
 Heiner, A., 22.
 Heinicke, A. J., 47.
 Heinrici, G., 39.
 Helm, C. A., 39.
 Helme, N., 60.
 Helmick, B. C., 28.
 Helmreich, F. H., 61.
 Helsler, M. D., 20.
 Helyar, F. G., 43, 44.
 Hemenway, A. F., 3.
 Hemenway, C. F., 13.
 Hemmer, C. W., 18.
 Hendershott, R. A., 53.
 Henderson, A. M., 22.
 Henderson, E. W., 38.
 Henderson, H. O., 70.
 Henderson, P. I., 20.
 Henderson, R., 72.
 Hendricks, S. B., 24.
 Hendrickson, A. H., 7.
 Hendrickson, C. I., 9.
 Hendrix, W. R., 27.
 Hendry, G. W., 5.
 Henke, L. A., 13.
 Henney, H. J., 24.
 Henning, J. C., 48.
 Henning, W. L., 57.
 Henricksen, H. C., 59.
 Henry, A. W., 36.
 Henry, M. F., 47.
 Hensel, F. W., 65.
 Hensley, H. C., 38.
 Henson, E. R., 21.
 Hepburn, W. M., 19.
 Hepler, J. R., 43.
 Hepner, F. E., 73.
 Heppner, M. J., 7.
 Herbert, P. A., 33.
 Herms, W. B., 6.
 Herrick, G. W., 47.
 Herring, G. C., 67.
 Herrington, G. L., 63.
 Hertz, H. F., 21.
 Herzer, F. H., 37.
 Hesler, L. R., 62.
 Hetzel, R. D., III, 42.
 Heukelekian, H. N., 44.
 Heuser, G. F., 48.
 Hewitt, E. A., 36.
 Heyle, E. M., 39.
 Hibbard, B. H., 71.
 Hibbard, P. L., 5.
 Hibbard, R. P., 32.
 Hickman, C. W., 14.
 Hicock, H. W., 10.
 Hienton, T. E., 18.
 Hieronymus, R. E., 16.
 Higgins, B. B., 13.
 Higgins, F. L., 34.
 Higgins, H., 64.
 Higgins, L. A., 37.
 Higgins, M. V., 73.
 Hill, C. E., 69.
 Hill, C. O., 63.
 Hill, E. B., 34.
 Hill, G. R., jr., 65.
 Hill, H. H., 67.
 Hill, H. S., 29.
 Hill, J. A., 73.
 Hill, J. B., 58.
 Hill, J. E., 16.
 Hill, R. L., 65.
 Hill, S. W., 49.
 Hillman, V. R., 24.
 Hills, J. L., III, 66.
 Hillstrom, E. G., 72.
 Hiltabrand, W. P., 15.
 Hilyer, V., 11.
 Hinds, W. E., 28.
 Hine, J. S., 53.
 Hinkle, C. P., 52.
 Hinman, R. B., 46.
 Hinote, J., 38.
 Hinse, F. C., 20.
 Hinshaw, W. R., 24.
 Hirst, C. T., 65.
 Hisaw, F. L., 25.
 Hitch, R. E., 63.
 Hitchcock, E. A., 52.
 Hitchcock, J. A., 66.
 Hitchner, E. R., 28.
 Hite, B. C., 56.
 Hitt, J. W., 39.
 Hixon, R. M., 20.
 Hoagland, D. R., 5.
 Hobart, I., 35.
 Hobbs, C. W., 25.
 Hobbs, W. R., 53.
 Hoblitzell, J. M., 30.
 Hodges, J. A., 24.
 Hodgkins, Mrs. W. H., 63.
 Hodgkiss, H. E., 58.
 Hodgson, M., 56.
 Hodgson, R. E., 36.
 Hodsden, B. M., 67.
 Hodson, E. A., 4.
 Hoerner, J. L., 8.
 Hobar, O. M., 73.
 Hoffarth, J., 33.
 Hoffer, G. N., 18.
 Hoffman, A. H., 6.
 Hoffman, G., 40.
 Hoffman, I. C., 19.
 Hoffman, J., 62.
 Hoffman, L., 19.
 Hoffman, L. M., 55.
 Hoffman, W. F., 34.
 Hoffmann, C. P., 61.
 Hoffmann, W. E., 35.
 Hogan, A. G., 38.
 Hogenson, J. C., 65.
 Hoke, S., 23.
 Holben, F. J., 57.
 Kolbert, J. C., 20.
 Holdaway, C. W., 67.
 Holden, E. D., 71.
 Holden, J. A., 42.
 Holland, C. S., 22.
 Holland, E. B., 31.
 Holland, E. O., 68.
 Holland, L. R., 51.
 Hollen, E. E., 47.
 Hollis, M. M., 17.
 Hollister, S. P., 9.
 Holman, A., 25.
 Holman, R. M., 5.
 Holmes, C. L., 20.
 Holmes, F. S., 29.
 Holmes, S. P., 38.
 Holsinger, C. V., 22.

- Holt, B. A., 35.
 Holton, E. L., 24.
 Holtz, H. F., 69.
 Honey, E. E., 48.
 Honeywell, E., 39.
 Hood, F. H., 64.
 Hook, A. M., 29.
 Hooker, H. D., jr., 39.
 Hooper, J. J., 26.
 Hooper, S., 51.
 Hooper, W. B., 7.
 Hootman, H. D., 33.
 Hopkins, A. W., 72.
 Hopkins, E. F., 48.
 Hopkins, H. S., 23.
 Hopkins, J. A., jr., 21.
 Hopkins, J. V., 70.
 Hopper, H. A., 46.
 Hopper, T. H., 51.
 Hoppert, E. H., 42.
 Hopphan, E. L., 27.
 Horat, L. E., 18.
 Horlacher, L. J., 26.
 Horlacher, W. R., 64.
 Horne, C. E., 59.
 Horne, W. T., 7.
 Horner, J. T., 32.
 Horsfall, H., 70.
 Horsfall, J. L., 58.
 Horst, H. E., 52.
 Horton, H. D., 8.
 Horton, M. F., 64.
 Horton, P. M., 27.
 Hoskins, E. R., 46.
 Hoskins, W. M., 42.
 Hosmer, R. S., 47.
 Hostetler, E., 49.
 Hotchkiss, M., 44.
 Hotchkiss, W. S., 65.
 Hott, N. M., 35.
 Hottes, A. C., 53.
 Hottes, C. F., 15.
 Hough, W. S., 67.
 House, E. B., 8.
 Houser, J. S., 53.
 Houser, T., 53.
 Hoverstad, A. T., 34.
 Hovis, W. A., 39.
 Howard, G. F., 35.
 Howard, J. T., 31.
 Howard, J. W., 12.
 Howard, R. F., 42.
 Howard, W. H. A., 11.
 Howard, W. L., 7.
 Howarth, J. A., 69.
 Howe, A., 19.
 Howe, E., 24.
 Howe, F. B., 45.
 Howe, G. H., 49.
 Howe, W. F., 31.
 Howell, C. E., 5.
 Howell, W. C., 37.
 Howells, M. K., 22.
 Howes, H. L., 43.
 Howey, M. O., 41.
 Howlett, F. S., 48.
 Hoy, H. H., 62.
 Hoyle, S. C., 65.
 Hoyt, H. R., 54.
 Hrutford, S., 36.
 Hubbard, B., 58.
 Hubbard, C. M., 68.
 Huber, B., 22.
 Huber, H. F., 44.
 Huber, L. L., 53.
 Hubert, B. F., 2.
 Huberty, M. R., 6.
 Hucker, G. J., 48.
 Hockett, H. C., 49.
 Huddleson, I. F., 33.
 Hudson, C. R., 50.
 Hudson, K., 25.
 Hudson, R. S., 32.
 Huelsen, W. A., 17.
 Huffman, C. F., 37.
 Huggins, B. E., 42.
 Hughes, E. H., 5.
 Hughes, H. D., 21.
 Hughes, H. L., 67.
 Hughes, J. L., 9.
 Hughes, J. S., 24.
 Hughes, O., 33.
 Hughes, W. L., 64.
 Hulbert, A. M., 44.
 Hulbert, H. W., 14.
 Hulce, R. S., 71.
 Hull, D. C., 36.
 Hull, E. D., 28.
 Hull, M., 28.
 Hullihen, W., 10.
 Hultz, S. F., 73.
 Humbert, E. P., 64.
 Hume, A. N., 61.
 Humfeld, H., 57.
 Hummel, B. L., 38.
 Humphrey, G. C., 71.
 Humphrey, J. E., 26.
 Hungerford, C. W., 15.
 Hungerford, DeF., 12.
 Hunn, C. E., 48.
 Hunsaker, A. F., 51.
 Hunt, C. H., 53.
 Hunt, H. R., 34.
 Hunt, J. J., 64.
 Hunt, L. W., 69.
 Hunt, R. E., 67.
 Hunt, T. F., 5.
 Hunt, T. Fr., 6.
 Hunter, F. B., 47.
 Hunter, H. M., 39.
 Hunter, J. E., 38.
 Hunter, Mrs. M. E. V., 65.
 Hunter, M. M., 40.
 Hurd, C. J., 56.
 Hurd, J. L., 22.
 Hurd, L. M., 48.
 Hursh, C. R., 36.
 Hurst, F. J., 37.
 Hurst, H., 45.
 Hurt, R. H., 67.
 Hussey, F., 62.
 Huston, H., 53.
 Huston, R. C., 32.
 Hutcheson, J. R., 67.
 Hutcheson, T. B., 67.
 Hutchinson, A. E., 40.
 Hutchinson, J., 17.
 Hutchison, C. B., 5.
 Hutson, J. B., 26.
 Hutson, R., 44.
 Hutton, C. A., 62.
 Hutton, J. G., 61.
 Hutton, J. P., 33.
 Huyke, J. B., 59.
 Hyde, Mrs. B. E., 8.
 Hyde, L. S., 20.
 Hypes, J. L., 9.
 Hyslop, G. R., 56.
 Ibsen, H. L., 23.
 Iddings, E. J., 14.
 Iftner, G. H., 15.
 Iler, W. D., 26.
 Ilg, C., 44.
 Imlay, F., 22.
 Ince, J. W., 60.
 Ingalls, E. L., 66.
 Ingram, C., 54.
 Ingram, D., 40.
 Irish, J. H., 7.
 Irvin, C. J., 57.
 Irving, D. F., 64.
 Isbell, C. L., 1.
 Isely, D., 4.
 Israelsen, O. W., 66.
 Itano, A., 31.
 Iverson, C. A., 20.
 Ives, F. W., 52.
 Ivey, J. E., 1.
 Jackman, E. R., 56.
 Jackson, A. D. (N. H.), 43.
 Jackson, A. D. (Tex.), 65.
 Jackson, C. F., 43.
 Jackson, G. A., 67.
 Jackson, H., 13.
 Jackson, H. C., 46.
 Jackson, H. L., 60.
 Jackson, H. R., 26.
 Jackson, H. S., 18.
 Jackson, M., 26.
 Jackson, M. B., 63.
 Jackson, M. E., 29.
 Jackson, M. L., 68.
 Jackson, S. C., 38.
 Jackson, S. K., 49.
 Jackson, T. H., 55.
 Jackson, W. E., 55.
 Jacob, H. E., 7.
 Jacob, M., 62.
 Jacobi, G. E., 29.
 Jacobs, N. B., 69.
 Jacobsen, E. A., 17.
 Jacobson, L. O., 22.
 Jacobson, M. A., 62.
 Jacobson, M. G., 35.
 Jacobson, W. E., 15.
 Jacobus, S., 71.
 Jaffa, M. E., 7.
 Jager, F., 35.
 James, C., 43.
 James, C. M., 18.

- James, J. A., 71.
 James, R. W., 70.
 Jamison, A. W., 4.
 Jamison, H. E., 16.
 Jamison, N. C., 55.
 Janssen, G., 71, 72.
 Jardine, J. T., 55.
 Jardine, W. M., 23.
 Jarmon, J. D., 63.
 Jarnagin, M. P., 12.
 Jason, W. B., 39.
 Jay, D. A., 8.
 Jefferies, J. H., 11.
 Jeffers, D. S., 22.
 Jefferson, L. P., 31.
 Jeffords, S. L., 60.
 Jeffrey, A. A., 39.
 Jeffries, C. D., 59.
 Jehle, R. A., 30.
 Jenkins, E. G., 29.
 Jenkins, E. H., 10.
 Jenkins, E. W., 66.
 Jenkins, H. F., 17.
 Jenkins, J. C., 24.
 Jenkins, J. M., 28.
 Jenks, F. B., 66.
 Jennings, B. A., 46.
 Jennings, D. S., 65.
 Jennings, W. C., 14.
 Jennonson, H. M., 62.
 Jensen, A. E., 56.
 Jensen, C., 55.
 Jensen, I. J., 40.
 Jensen, K., 15.
 Jerdan, A. L., 63.
 Jernigan, W. J., 4.
 Jesness, O. B., 26.
 Jessup, J. G., 23.
 Jeter, F. H., 50.
 Jewett, H. H., 26.
 Jewett, J. L., 8.
 Jewett, R. M., 29.
 Joffe, J. S., 43.
 Johannsen, O. A., 47.
 Johnakin, M., 61.
 Johnson, Mrs. A. E., 65.
 Johnson, A. G., 56.
 Johnson, A. N., 29.
 Johnson, Mrs. A. T., 63.
 Johnson, Mrs. B. M., 38.
 Johnson, C. C., 69.
 Johnson, C. E., 35.
 Johnson, D. R., 21.
 Johnson, E., 22.
 Johnson, E. C. (Minn.), 35.
 Johnson, E. C. (Wash.), 68.
 Johnson, E. M., 26.
 Johnson, H. E., 33.
 Johnson, Mrs. H. F., 60.
 Johnson, J., 72.
 Johnson, M., 4.
 Johnson, O. M., 71.
 Johnson, O. N., 71.
 Johnson, O. R., 38.
 Johnson, R. W., 15.
 Johnson, S. A., 7, 8.
 Johnson, T. C., 67, 68.
 Johnson, W. T., 69.
 Johnston, A. D., 35.
 Johnston, C. N., 6.
 Johnston, C. O., 24.
 Johnston, E. S., 30.
 Johnston, H., 1.
 Johnston, J. C., 7.
 Johnston, R. B., 61.
 Johnston, S., 34.
 Johnston, T. R., 19.
 Johnston, W. W., 57.
 Jolly, J. H., 27.
 Jonas, Mrs. M. D., 26.
 Jones, A., 53.
 Jones, Mrs. A. H., 22.
 Jones, B. C., 64.
 Jones, C. H., 66.
 Jones, C. P., 31.
 Jones, C. R. (Colo.), 8.
 Jones, C. R. (W. Va.), III, 69.
 Jones, C. W., 41.
 Jones, D. F., 10.
 Jones, D. L., 65.
 Jones, E., 52.
 Jones, E. B., 11.
 Jones, E. H., 51.
 Jones, E. R., 71.
 Jones, F. R., 64.
 Jones, H. A., 7.
 Jones, H. M. (Kans.), 23.
 Jones, H. M. (S. Dak.), 62.
 Jones, H. W., 63.
 Jones, J. C., 47.
 Jones, J. H., 71.
 Jones, J. M., 64.
 Jones, J. P., 30.
 Jones, J. S., 56.
 Jones, J. W., 26.
 Jones, K. D., 7.
 Jones, K. U., 37.
 Jones, L. G., 64.
 Jones, L. K., 72.
 Jones, L. L., 18.
 Jones, L. R., 72.
 Jones, M. D., 29.
 Jones, M. E., 44.
 Jones, M. L., 20.
 Jones, M. M., 38.
 Jones, Mrs. M. W., 2.
 Jones, Mrs. N. K., 72.
 Jones, R. B., 2.
 Jones, R. C., 55.
 Jones, R. E., 9.
 Jones, R. L., 60.
 Jones, R. W. (Ga.), 12.
 Jones, R. W. (Ky.), 27.
 Jones, S. C., 26.
 Jones, V., 15.
 Jordan, E. L., 27.
 Jordan, H. V., 39.
 Jordan, P. S., 36.
 Jordan, R., 19.
 Jordan, T. J., 28.
 Jordan, W. E., 49.
 Jordan, W. R., 64.
 Jordon, O., 37.
 Jorgenson, L., 51.
 Joseph, G. H., 24.
 Joseph, W. E., 40.
 Judd, S. G., 66.
 Judisch, G., 23.
 Judkins, H. F., 30.
 Julian, J. S., 63.
 Justin, M. M., 24.
 Kable, G. W., 56.
 Kadderly, W. L., 56.
 Kahl, L., 27.
 Kalkus, J. W., 69.
 Kammlade, W. G., 16.
 Karper, R. E., 65.
 Karraker, A. H., 15.
 Karraker, P. E., 26.
 Kaupp, B. F., 49.
 Kays, D. J., 52.
 Keaney, F. W., 60.
 Kedzie, R. H., 28.
 Keegan, L. A., 59.
 Keegan, W. J., 60.
 Keen, R. C., 28.
 Keene, E. S., 50.
 Keene, P. L., 62.
 Keener, R. L., 12.
 Keep, E., 47.
 Keever, A., 35.
 Keffer, C. A., 62.
 Keiffer, R. F., 8.
 Keim, F. D., 41.
 Keiser, L. A., 56.
 Keith, E. B., 24.
 Keith, M. H., 16.
 Keithline, M., 62.
 Keitt, G. W., 72.
 Kelk, O. M., 29.
 Kell, W. V., 19.
 Kellar, V. M., 29.
 Kelleher, R. C., 17.
 Keller, A. R., 13.
 Keller, H., jr., 43, 44.
 Keller, L., 63.
 Kellerman, K. F., III.
 Kelley, A. L., 63.
 Kelley, A. M., 44.
 Kelley, A. P., 43.
 Kelley, J. B., 26.
 Kelley, V. W., 17.
 Kelley, W. P., 5.
 Kellogg, C. E., 12.
 Kellogg, R. M., 47.
 Kelly, A., 24.
 Kelly, E., 10.
 Kelly, E. G., 24.
 Kelly, E. L., 70.
 Kelly, H. R., 56.
 Kelly, J. G., 11.
 Kelly, J. J., 64.
 Kelly, J. P., 58.
 Kely, R. H., 32.
 Kemp, W. B., 29.
 Kempster, H. L., 38.
 Kendall, F. E., 16.
 Kendall, J. C., 42.
 Kendrick, J. B., 18.
 Kendrick, W. H., 70.

- Kenestrick, H., 52.
 Kennard, D. C., 53.
 Kennedy, A. C., 52.
 Kennedy, C., 34.
 Kennedy, C. H., 53.
 Kennedy, M. M., 27.
 Kennedy, P. B., 5.
 Kennedy, R. H., 56.
 Kenney, F. C., 31.
 Kenney, R., 26.
 Kent, H. L., III, 45.
 Kerlin, I. B., 37.
 Kern, F. D., 58.
 Kern, O. J., 6.
 Kernkamp, H. C. H., 36.
 Kernohan, G., 58.
 Kerns, A. H., 25.
 Kerns, F. E., 13.
 Kerr, A. P., 27.
 Kerr, W. J., 55.
 Kessler, N. A., 33.
 Ketchum, M. S., III, 15.
 Kettunen, A. G., 32.
 Keyes, W. B., 22.
 Kezer, A., 7.
 Kherli, F. W., 68.
 Kiah, T. H., 30.
 Kidder, W., 7.
 Kieser, P. W., 62.
 Kiesselbach, T. A., 41.
 Kildare, A. A., 68.
 Kildee, H. H., 19.
 Kilgore, B. W., 49.
 Kilgore, Mrs. D. H., 22.
 Killough, D. T., 64.
 Kilpatrick, E. J., 26.
 Kimball, D. S., 45.
 Kime, P. H., 49.
 Kimrey, A. C., 49.
 King, A. C., 45.
 King, C., 28.
 King, C. M., 20.
 King, F. G., 18.
 King, H. H., 24.
 King, R. H., 14.
 Kinghorn, I. G., 8.
 Kingman, H. E., 8.
 Kinley, D., 15.
 Kinney, E. J., 26.
 Kinney, L. F., jr., 60.
 Kinnison, A. F., 3.
 Kinsella, J. C., 18.
 Kinslow, A., 72.
 Kinsman, D. F., 45.
 Kipps, M. S., 67.
 Kirby, R. S., 58.
 Kirby, S. J., 50.
 Kirkland, L. C., 45.
 Kirkpatrick, E. E., 2.
 Kirkpatrick, P., 13.
 Kirkpatrick, R. T., 39.
 Kirkpatrick, W. F., 9.
 Kirkwood, W. P., 36.
 Kirshman, H. D., 13.
 Kiser, O. M., 36.
 Kiser, R. W., 23.
 Kistler, P. T., 57.
 Kistner, R. C., 19.
 Kitselman, C. H., 25.
 Kjorlie, H. E., 51.
 Kjosness, A. W. B., 15.
 Kleinheinz, F., 71.
 Klingner, M. L., 39.
 Klotz, L. J., 43.
 Knandel, H. C., 57.
 Knapp, B., III, 54.
 Knapp, I. R., 58.
 Knappenberger, L., 22.
 Knight, B., 30.
 Knight, H., 6.
 Knight, H. G., III, 69.
 Knight, H. H., 35.
 Knight, R. B., 37.
 Knipe, F. W., 9.
 Knoll, F. P., 58.
 Knott, A. W., 23.
 Knott, J., 68.
 Knowles, N. S., 21.
 Knowles, W. F., 43.
 Knowlton, F. L., 55.
 Knowlton, H. E., 70.
 Knox, C. W., 20.
 Knox, J. H., 16.
 Knudson, L., 46.
 Knutsen, M. H., 58.
 Knutson, G., 8.
 Koch, A., 32.
 Kochheiser, D. S., 52.
 Koerber, J., 6.
 Koenig, L. A., 64.
 Kohl, E. J., 18.
 Kohn, F. J., 73.
 Kokoski, F. J., 31.
 Kolb, J. H., 71.
 Kolshorn, A., 35.
 Koon, R. M., 31.
 Kostalek, J. A., 14.
 Kostir, W. J., 53.
 Kotjla, J. E., 32.
 Kraft, J. H., 64.
 Kramer, M. M., 25.
 Kramer, W. H., 54.
 Krantz, E. B., 73.
 Krantz, F. A., 36.
 Krauss, F. G., 13.
 Krauss, W. E., 46.
 Kraybill, H. R., 43.
 Kreckler, F. H., 53.
 Kremer, J. C., 32.
 Kremers, L. R., 72.
 Kriss, M., 59.
 Kroh, S. J., 14.
 Krout, W. S., 58.
 Krueger, J., 33.
 Krueger, W. C., 63.
 Krum, O. C., 8.
 Krum, W. G., 48.
 Kruse, P. J., 46.
 Krusekopf, H. H., 39.
 Kuehner, C. L., 72.
 Kuenning, A. C., 51.
 Kuerner, G., 24.
 Kuhlman, A. H., 61.
 Kumlien, W. F., 61.
 Kumerth, W., 22.
 Kunst, F. B., 70.
 Kuntz, W. A., 58.
 Kurtz, L. D., 32.
 Kutsunai, Y., 14.
 Kyle, E. J., 63, 64.
 Kynette, C. M., 2.
 Kzyer, E. D., 61.
 La Bossier, I., 40.
 Lackey, J. B., 44.
 Lacroix, D. S., 31.
 La Croix, M. M., 28.
 Ladd, C. E., 46.
 Ladd, J. E., 59.
 Lafene, B. W., 27.
 LaGrange, W. F., 20.
 Laible, R. J., 16.
 La Master, J. P., 60.
 Lamb, A. R., 20.
 Lamb, J., jr., 15.
 Lambert, W. V., 21.
 Lampe, E. M. R., 10.
 Lampe, L., 52.
 Lampman, C. E., 71.
 Lamson, G. H., jr., 9.
 Lancaster, C. A., 2.
 Lancaster, D. S., 67.
 Lancaster, Mrs. L. R., 22.
 Lancaster, R. R., 64.
 Lancelot, W. H., 21.
 Landon, I. K., 23.
 Landon, Mrs. L. E., 34.
 Landrum, L. I., 60.
 Lane, F. P., 73.
 Lang, A. L., 16.
 Langdon, G. E., 72.
 Langsford, E. L., 26.
 Lanham, W. B., 64.
 Lanman, F. R., 52.
 Lanphear, M. O., 30.
 Lansden, H. B., 11.
 Lantow, J. L., 45.
 Lantz, H. L., 22.
 Lapp, W. H., 20.
 Larsen, C., 61.
 Larson, A. H., 36.
 Larson, G. A., 61.
 Larson, R. A., 61.
 Larson, R. G., 56.
 Lathrop, A. W., 71.
 Lathrop, F. H., 49.
 Lathrop, F. W., 35.
 Latimer, L., 11.
 Latshaw, W. L., 24.
 Latta, W. C., 17.
 Lattig, H. E., 15.
 Laude, H. H., 23.
 Lauman, G. N., 46.
 Lautenschlager, V. E., 68.
 Lawrence, E. R., 54.
 Lawrence, M. M., 69.
 Lawrence, W. E., 56.
 Lawritson, M. N., 41.
 Laws, A. G., 38.
 Lawson, B. C., 16.

- Lawson, W. W., 10.
 Laycock, W. E., 33.
 Layton, H. B., 61.
 Lea, E. J., 7.
 Leach, J. G., 36.
 Leaming, M. M., 44.
 Learn, C. D., 8.
 Leaton, L. L., 62.
 Leavenworth, C. S., 10.
 Leazenby, A.-J., 25.
 LeBron, L. C., 1.
 Lee, A. M., 73.
 Lee, B. L., 40.
 Lee, C. E., 48.
 Lee, D. W., 55.
 Lee, H. A., 14.
 Lee, J. G., 28.
 Lee, J. G., jr., 27.
 Lee, V. P., 64.
 Leeb, C., 51.
 Leete, B. E., 54.
 Leggett, H. A. D., 66.
 Lehenbauer, P. A., 42.
 Lehman, S. G., 49.
 Lehmann, E. W., 17.
 Leiby, R. W., 50.
 Leidigh, A. H., 63.
 Leith, B. D., 71.
 Leith, T. B., 70.
 Leland, E. W., 45.
 Leland, O. M., III, 34.
 Leland, T. W., 64.
 Lenhart, L. A., 35.
 Lent, B. F., 3.
 Lentz, J. B., 31.
 Leonian, L. H., 70.
 Lepkovsky, S., 71.
 Lesh, C. Z., 3.
 Lesley, J. W., 6.
 Letson, O. W., 39.
 Levie, T., 12.
 Levine, A. A., 68.
 Levine, M., 20.
 Lewis, A., 15.
 Lewis, E. M., 30.
 Lewis, E. P., 33.
 Lewis, F. C., 18.
 Lewis, I. D., 61.
 Lewis, I. P., 54.
 Lewis, J. V., 44.
 Lewis, L. H., 60.
 Lewis, L. M., 57.
 Lewis, M. R., 15.
 Lewis, R. D., 57.
 Lewis, S. L., 42.
 Lewis, V. W., 50.
 Lewis, W. C., 32.
 Lewis, W. P., 43.
 Liddell, J. G., 12.
 Lienhardt, H. F., 25.
 Lightbody, H. D., 32.
 Lindberg, H., 3.
 Linder, G., 8.
 Lindgren, H. A., 55.
 Lindquist, R. M., 22.
 Lindsay, R. H., 38.
 Lindsey, J. B., 31.
 Lindstrom, E. W., 21.
 Linfield, A., 62.
 Linfield, F. B., 40.
 Linford, J. H., 66.
 Linklater, W. A., 69.
 Linsley, C. M., 16.
 Lipman, C. B., 5.
 Lipman, J. G., III, 43, 44.
 Lipp, C. C., 62.
 Lippincott, W. A., 5.
 Lippincott, W. L., 60.
 Lipscomb, J. N., 37.
 Lisse, M. W., 58.
 List, G. M., 8.
 Little, C. C., III, 28.
 Little, E., 43.
 Little, M. C., 72.
 Little, V. A., 64.
 Littlehale, A. D., 43.
 Littlejohn, L. W., 55.
 Lively, C. E., 52.
 Livermore, J. R., 45.
 Livesay, E. A., 69.
 Livingston, A. S., 41.
 Livingston, L. F., 33.
 Livingston, R. H., 52.
 Lloyd, J. W., 17.
 Lloyd, O. G., 19.
 Lloyd, W. E., 5.
 Lobdell, R. N., 37.
 Locklin, H. D., 69.
 Lockwood, Mrs. M. P., 3.
 Lockwood, W. P. B., 30.
 Loeffel, W. J., 41.
 Logan, L. E., 26.
 Lohmann, K. B., 17.
 Lomanitz, S., 43.
 Lommel, C. H., 19.
 Lommel, W. E., 19.
 Long, C. L., 57.
 Long, H. D., 51.
 Long, J. D., 6.
 Long, R. L., 63.
 Long, W. W., 60.
 Longley, L. E., 15.
 Longyear, B. O., 8.
 Loomer, H. G., 21.
 Loomis, W. E., 48.
 López, F. A., 59.
 Lord, E. L., 11.
 Lord, R., 53.
 Loree, R. E., 33.
 Lory, C. A., III, 7.
 Lott, E. H., 40.
 Lott, W. A., 43.
 Loudon, Mrs. D. A., 51.
 Love, H. H., 45.
 Lovejoy, O. L., 5.
 Loveland, G. A., 42.
 Lovett, A. L., 56.
 Lowe, Mrs. E. S., 55.
 Lowe, I. D., 70.
 Lowell, A. W., 32.
 Lowry, P. H., 54.
 Lowrey, G. E., 25.
 Lowry, E. M., 8.
 Lowry, M. W., 12.
 Lowry, P. R., 43.
 Lowry, R. B., 62.
 Lubbehusen, R. E., 36.
 Lucas, D. B., 43.
 Lucas, J. B., 67.
 Lucas, P. S., 32.
 Luce, M. E., 66.
 Luce, W. A., 69.
 Luckett, J. D., 49.
 Ludwig, C. A., 60.
 Lueder, C. A., 70.
 Lundberg, M. G., 9.
 Lunn, A. G., 55.
 Lush, J. L., 64.
 Lush, R. H., 23.
 Lute, A. M., 8.
 Luther, E. L., 72.
 Luther, M. E., 72.
 Lutman, A. S., 66.
 Lutman, B. F., 66.
 Luttrell, E., 3.
 Lyles, T. J., 61.
 Lyman, G. R., III, 69.
 Lyman, J. F., 52.
 Lynch, J. E., 57.
 Lyness, W. E., 41.
 Lynn, G. I., 22.
 Lyon, H. L., 14.
 Lyon, T. L., 45.
 Lyons, E. S., 23.
 Lyons, J. H., 27.
 McAdams, J. H., 24.
 McAdams, M. E., 17.
 McAdory, I. S., 2.
 McAlister, J. T., 60.
 McAlle, W. R., 13, 14.
 McAlpine, J. G., 9.
 McAmis, J. C., 62.
 McArthur, L. J., 62.
 McBride, C. G., 52.
 McBride, O. C., 35.
 McCall, A. G., 30.
 McCall, L. J., 65.
 McCall, M. A., 69.
 McCall, T. M., 36.
 McCallan, S. E. A., 48.
 McCally, R. L., 18.
 McCampbell, C. W., 23.
 McCann, R., 7.
 McCarty, E. C., 8.
 McCarty, M. A., 34.
 McCaustland, E. J., 38.
 McChord, R. C., 40.
 McCleery, W. L., 14.
 McClelland, C. K., 4.
 McClelland, J. B., 52.
 McClelland, T. B., 59.
 McClintock, J. A., 62.
 McClintock, J. E., 53.
 McCluer, D., 37.
 McClure, F. J., 18.
 McClure, G. M., 53.
 McClymonds, A. E., 15.
 McCollam, M. E., 69.
 McCulloch, J. W., 24.

- McComb, J. D., 56.
 McConnell, R. E., 51.
 McCool, M. M., 33.
 McCord, J. L. E., 58.
 McCormick, F. A., 10.
 McCoy, J. E., 69.
 McCoy, W. C., 12.
 McCue, C. A., III, 10.
 McCuen, G. W., 52.
 McCullough, H., 17.
 McCullough, H. D., 62.
 McCurdy, J. C., 46.
 McDaniel, E. I., 32.
 McDole, G. R., 14.
 McDole, Mrs. R. P., 15.
 McDonald, C. W., 20.
 McDonald, M., 21.
 McDonel, K. H., 32.
 McDonnell, H. B., 29.
 McDowell, M. S., 57.
 McEldowney, G. A., 14.
 McElroy, C. H., 55.
 McFadden, H. F., 68.
 McFall, R. J., 31.
 McFarland, Mrs. F. M., 30.
 McFarland, K. H., 19.
 McFaul, H., 56.
 McFeely, A., 36.
 McGeorge, W. T., 14.
 McGilliard, P. C., 24.
 McGinnis, E., 29.
 McGinnis, F. W., 34.
 McGinty, R. A., 8.
 McGregor, H. L., 47.
 McGuire, L. M., 53.
 McHargue, J. S., 26.
 McHatton, T. H., 12.
 McLlroy, Mrs. C. B., 47.
 Mellroy, G. W., 16.
 Mellvaine, T. C., 70.
 Mellwain, D. W., 36.
 McInerney, T. J., 46.
 McIntosh, A., 37.
 McIntosh, C. J., 57.
 McKay, A. B., 37.
 McKay, H., 53.
 McKay, H. M., 12.
 McKay, J. F., 37.
 McKay, L. H., 60.
 McKay, L. J., 38.
 McKay, M. B., 56.
 McKee, C., 40.
 McKee, J. C., 37.
 McKellip, I., 52.
 McKenney, G., 26.
 McKenzie, M. C., 22.
 McKibben, E. G., 6.
 McKimmon, Mrs. J. S., 50.
 McKinley, Mrs. L. E., 19.
 McKittrick, E. J., 73.
 McLaughlin, F. A., 31.
 McLaughlin, Mrs. H. F., 43.
 McLaughlin, H. M., 20.
 McLean, F. T., 60.
 McLean, H. C., 44.
 McLeod, J. H., 62.
 McLeod, W. M., 25.
 McMahan, A. L., 40.
 McMahan, D., 51.
 McMahan, J., 35.
 McMiller, P. R., 36.
 McMullen, E. C., 48.
 McNabb, C. A., 45.
 McNair, A. D., 4.
 McNall, P. E., 71.
 McNaughton, E. B., 30.
 McNeal, N. H., 47.
 McNeal, W. B., 35.
 McNeel, W., 72.
 McNees, W. H., 73.
 McNess, G. T., 65.
 McNulty, S. A., 72.
 McNutt, G. W., 23.
 McNutt, J. C., 42.
 McNutt, S. H., 23.
 McPheeters, M. R., 55.
 McPheeters, W. H., 55.
 McRae, J. A., 50.
 McReynolds, R., 51.
 McTeer, F. D., 63.
 McVeety, Mrs. E., 51.
 McVey, F. L., 26.
 McVey, W. M., 18.
 Mabee, W. B., 50.
 Maberry, Mrs. E., 28.
 MacDaniels, L. H., 48.
 MacDonald, G. B., 22.
 MacDonald, L., 9.
 Macfarlane, J., 43.
 Machlis, J. A., 61.
 MacIntire, W. H., 63.
 Mack, M. E., 42.
 Mack, W. B., 58.
 Mackenzie, P. C., 57.
 Mackey, A. K., 16.
 Mackey, B. B., 27.
 Mackie, W. W., 5.
 Mackintosh, D. L., 24.
 Mackintosh, R. S., 36.
 Macklin, T., 71.
 MacLeod, G. F., 49.
 Macpherson, H., 56.
 Macy, H., 34.
 Madison, L. C., 57.
 Madson, B. A., 5.
 Maeser, S., 65.
 Magee, L. G., 22.
 Magill, E. C., 67.
 Magill, W. W., 27.
 Magnuson, H. P., 14.
 Magruder, D. G., 68.
 Magruder, R., 54.
 Mahan, C. A., 26.
 Mains, E. B., 18.
 Mairs, T. I., 58.
 Major, H. F., 39.
 Mallman, W. LeR., 33.
 Mallon, M. G., 19.
 Malone, R. E., 4.
 Manchester, A. W., 9.
 Maneval, W. E., 38.
 Maney, T. J., 22.
 Mangels, C. E., 51.
 Mangelsdorf, P. C., 10.
 Manhart, V. C., 18.
 Manley, P. C., 67.
 Mann, A. R., III, 45.
 Mann, M. C., 6.
 Manning, F. L., 43.
 Manning, H., 72.
 Manning, W. E., 46.
 Manns, T. F., 10.
 Manter, J. A., 9.
 Manuel, M. E., 68.
 Marcovitch, S., 63.
 Maris, P. V., 55.
 Marks, W. A., 4.
 Markuson, M. J., 67.
 Markwell, E. D., 55.
 Markwell, O. C., 14.
 Marlatt, A. L., 72.
 Marlatt, C. L., III.
 Marlatt, L. H., 12.
 Marquardt, J. C., 48.
 Marsh, G. H., 1.
 Marsh, H. V., 60.
 Marsh, R. F., 43.
 Marshall, C. E., 31.
 Marshall, H. C., 67.
 Marshall, J. D., 7.
 Marshall, R. E., 33.
 Marston, A., III, 19.
 Marston, H. W., 24.
 Marston, R. M., 29.
 Martin, A. C., 49.
 Martin, E. (Ark.), 4.
 Martin, E. (Nebr.), 41.
 Martin, E. F., 65.
 Martin, H. M. (Ala.), 1.
 Martin, H. M. (Nebr.), 42.
 Martin, J. C., 5.
 Martin, James H., 27.
 Martin, Jos. H., 26.
 Martin, J. N., 20.
 Martin, J. P., 14.
 Martin, L. (Md.), 30.
 Martin, L. (Mo.), 39.
 Martin, M. E. (Ala.), 2.
 Martin, M. E. (Ind.), 19.
 Martin, R. H., 27.
 Martin, T. T., 38.
 Martin, V. G., 37.
 Martin, W. H. (N. J.), 43, 44.
 Martin, W. H. (Pa.), 58.
 Martin, W. P., 25.
 Marvin, C. H., 3.
 Mason, A. F., 44.
 Mason, C. J., 9.
 Mason, E. L., 9.
 Mason, R. H., 4.
 Massey, A. B., 67.
 Massey, E. E., 37.
 Massey, L. M., 48.
 Matheson, R., 47.
 Mathews, C. W., 27.
 Mathews, F. P., 19.
 Mathews, H. B., 61.
 Mathews, S., 12.
 Mathewson, R. H., 9.
 Mathis, B. M., 55.
 Matthew, E. B., 4.

- Matthews, C. D., 50.
 Matthews, G. C., 35.
 Matthews, M. L., 19.
 Matthews, R. D. E., 37.
 Mauldin, E., 1.
 Maxwell, D., 37.
 Maxwell, M., 40.
 May, D. W., 59.
 May, E. C., 65.
 May, H. G., 59.
 Maycock, R. B., 66.
 Mayer, I. D., 18.
 Mayer, L. S., 62.
 Mayer, W. L., 50.
 Maynard, E. J., 8.
 Maynard, L. A., 46.
 Mayne, D. D., 35.
 Mayoue, G. C., 51.
 Meacham, E. R., 71.
 Meacham, F. T., 50.
 Mead, E., 6.
 Mead, R. F., 5.
 Meade, DeV., 29.
 Meader, A. L., 27.
 Meador, D. J., 2.
 Mebane, A. L., 11.
 Medlar, A. W., 41.
 Meek, H. B., 47.
 Megee, C. R., 33.
 Mehaffey, E. E., 43.
 Mehl, P., 9.
 Mehrhof, N. R., 43.
 Mekeel, A. G., 48.
 Melander, A. L., 69.
 Melchers, L. E., 24.
 Melhus, I. E., 20.
 Mellon, M. G., 18.
 Meloche, G. L., 72.
 Melvin, J. C., 26.
 Menaul, P. L., 55.
 Mendenhall, D. R., 72.
 Mendenhall, R., 4.
 Mensching, J. E., 48.
 Menville, R. L., 27.
 Merchant, C. H., 66.
 Mercier, W. B., 28.
 Meredith, R. M., 59.
 Merkle, F. G., 57.
 Merrill, A. R., 9.
 Merrill, E. D., 5.
 Merrill, J. F., 24.
 Merrill, J. H., 24.
 Merrill, L. H., 28.
 Merrill, L. S., 28.
 Merrill, R. M., 40.
 Merritt, J. L., 61.
 Mervine, E. M., 21.
 Metcalf, A. H., 40.
 Metcalf, H. J., 21.
 Metcalf, W., 6.
 Metcalf, Z. P., 50.
 Methley, W., 36.
 Metzger, H., 35.
 Metzger, H. J., 46.
 Metzger, J. E., 29.
 Meulen, P. A. van der, 43.
 Meybohm, Mrs. G. B., 35.
 Meyer, A. J., 38.
 Meyer, B. S., 52.
 Meyers, R., 55.
 Michels, C. A., 30.
 Mickel, C. E., 35.
 Mickey, M. R., 61.
 Middlebrook, R. L., 45.
 Middleton, A. R., 18.
 Middleton, J. A., 36.
 Milam, A. B., 56.
 Miles, G. F., 58.
 Miles, L. E., 1.
 Millar, C. E., 33.
 Miller, A. E., 53.
 Miller, C., 13.
 Miller, C. B., 21.
 Miller, C. E., 51.
 Miller, C. F., 49.
 Miller, E. A. (Okla.), 54.
 Miller, E. A. (Tex.), 65.
 Miller, E. C., 24.
 Miller, E. J., 32.
 Miller, E. R., 1.
 Miller, F. E., 50.
 Miller, F. G., 15.
 Miller, F. W., 57.
 Miller, G. E., 51.
 Miller, H. G., 56.
 Miller, J. W., 18.
 Miller, M. F., 39.
 Miller, M. M., 27.
 Miller, M. R., 42.
 Miller, P. E., 36.
 Miller, P. L., 21.
 Miller, P. T., 73.
 Miller, R. C. (Ky.), 26.
 Miller, R. C. (N. Dak.), 51.
 Miller, R. F., 5.
 Miller, R. N., 69.
 Miller, W. P., 52.
 Millin, R. B., 40.
 Mills, G. E., 8.
 Mills, H. S., 48.
 Mills, R. L., 49.
 Mills, W. H., 60.
 Milner, M. A., 70.
 Miltimore, C., 11.
 Milton, R. H., 62.
 Milum, V. G., 71.
 Milward, J. G., 72.
 Minns, L. A., 48.
 Minor, Mrs. E. H., 60.
 Minteer, C. C., 41.
 Misner, E. G., 46.
 Mitchell, E., 19.
 Mitchell, E. L., 28.
 Mitchell, H. H., 16.
 Mitchell, J. H., 60.
 Mixer, A. S., 29.
 Moen, J., 66.
 Moen, R. O., 50.
 Moffitt, E. L., 58.
 Mohlman, Z. H., 17.
 Moles, H. S., 45.
 Monahan, W. C., 30.
 Monosmith, P. B., 37.
 Monroe, C. F. (N. Mex.), 45.
 Monroe, C. F. (Ohio), 53.
 Monsch, H., 47.
 Montgomery, C. A., 67.
 Montgomery, C. W., 54.
 Montgomery, L. M., 53.
 Monzón, L. C., 59.
 Moody, H. W., 37.
 Mooers, C. A., 62.
 Moomaw, L., 51.
 Moon, C. B., 11.
 Moon, M. P., 46.
 Moore, A. R., 44.
 Moore, D. M., 52.
 Moore, H. C., 33.
 Moore, J. G., 72.
 Moore, J. S., 36.
 Moore, M. G., 49.
 Moore, M. H., 37.
 Moore, P., 14.
 Moore, R. A., 71.
 Moore, R. C., 67.
 Moore, V. P., 11.
 Moore, W., 22.
 Moore, W. D., 60.
 Moore, W. P., 67.
 Moorhead, J. G., 19.
 Moorhouse, L. A., 8.
 Mooring, D. C., 55.
 Moran, C., 43.
 Moran, W. H., 24.
 Mordoff, R. A., 48.
 Morehouse, M. C., 56.
 Moreland, C. C., 27.
 Moreland, C. F., 27.
 Moreland, E., 63.
 Moret, F. C., 59.
 Morgan, A. F., 6.
 Morgan, B., 21.
 Morgan, C. H., 2.
 Morgan, C. L., 60.
 Morgan, E. L., 38.
 Morgan, G. W., 40.
 Morgan, H. A., III, 62.
 Morgan, J. O., 63.
 Morgan, L. E., 27.
 Morgan, M., 51.
 Morgan, M. F., 10.
 Morgan, R. F., 41.
 Morgan, R. J., 63.
 Morgan, W. A., 13.
 Morison, F. L., 52.
 Morley, L. W., 58.
 Morrill, F. J., 29.
 Morrill, W. J., 8.
 Morris, H., 28.
 Morris, H. E., 40.
 Morris, H. J., 64.
 Morris, L. Z., 62.
 Morris, O. M., 69.
 Morris, V. H., 53.
 Morris, W. E., 35.
 Morrish, R. W., 24.
 Morrison, F. B., 71.
 Morrison, J., 53.
 Morrow, C. A., 34.
 Morrow, R. D., 36.
 Morse, A. P., 35.

- Morse, F. W., 31.
 Morse, W. C., 37.
 Morse, W. J., 28.
 Mortensen, M., 20.
 Mortimer, G. B., 171.
 Morton, C., 47.
 Morton, G. E., 7.
 Morton, G. M., 41.
 Morton, W. F., 49.
 Moses, B. D., 6.
 Moses, W., 47.
 Mosher, M. L., 17.
 Moss, A. E., 9, 10.
 Moss, E. G., 50.
 Moss, L. B., 58.
 Moss, W. A., 15.
 Most, B. R., 8.
 Mote, D. C., 56.
 Moton, R. R., 2.
 Motz, F. A., 67.
 Mount, M. M., 30.
 Mowry, H., 11.
 Moyer, J. H., 24.
 Mudge, C. S., 5.
 Muenschner, W. C., 46.
 Muggleston, H. B., 24.
 Muir, F., 14.
 Muldrow, M. W., 4.
 Mulford, W., 6.
 Muller, R. T., 31.
 Mullins, L. E., 30.
 Mulvania, M., 72.
 Mulvey, R. R., 17.
 Mumford, F. B., III, 38.
 Mumford, H. W., III, 15.
 Munn, M. T., 48.
 Munroe, H. D., 57.
 Murdock, D. W., 31.
 Murdock, H. E., 40.
 Murneek, A. E., 57.
 Murphey, F. T., 58.
 Murphey, H. S., 23.
 Murphree, A. A., 11.
 Murphy, E., 45.
 Murphy, H. F., 54.
 Murray, C., 23.
 Murray, M., 64.
 Murray, R. F., 71.
 Murray, T. J., 43.
 Musbach, F. L., 72.
 Musgrave, G. W., 43, 44.
 Mussehl, F. E., 41.
 Musselman, H. H., 33.
 Musser, A. M., 61.
 Musser, H. B., 57.
 Mustard, A. H., 69.
 Muttkowski, R. A., 15.
 Myer, D. S., 52.
 Myers, C. E., 58.
 Myers, C. H., 45.
 Myers, K. H., 17.
 Myers, L., 35.
 Myers, W. I., 46.
 Myrland, R. H., 72.
- Nabenhauer, F. P., 48.
 Nabours, R. K., 25.
 Nanz, R. S., 46.
 Naudain, G. G., 20.
 Naylor, H. R., 54.
 Naylor, N., 20.
 Naylor, P. B., 38.
 Neal, D. C., 37.
 Neale, P. E., 45.
 Neasham, E. W., 27.
 Neasham, R. L., 20.
 Needham, J. G., 47.
 Neel, L. R., 63.
 Neff, C. R., 28.
 Negley, N., 5.
 Nehrling, A. H., 48.
 Neidigh, R. E., 14.
 Neiswander, C. R., 53.
 Neller, J. R., 68.
 Nelson, A., 73.
 Nelson, B. G., 27.
 Nelson, C., 11.
 Nelson, C. I., 51.
 Nelson, D. H., 38.
 Nelson, J. A., 40.
 Nelson, J. B., 38.
 Nelson, M., 4.
 Nelson, M. A., 4.
 Nelson, M. H., 44.
 Nelson, Mrs. M. S., 71.
 Nelson, O. M., 56.
 Nelson, P. (Guam), 13.
 Nelson, P. (Utah), 66.
 Nelson, P. M., 22.
 Nelson, R., 32.
 Nelson, R. M., 36.
 Nelson, S. B., 68.
 Nelson, T. C., 44.
 Nelson, V. E., 20.
 Nelson, W. S., 38.
 Nesbitt, L. L., 51.
 Neson, G. H., 36.
 Ness, H. (Iowa), 23.
 Ness, H. (Tex.), 64.
 Nettleton, A. W., 54.
 Nettleton, H. I., 15.
 Nettleton, L. B., 54.
 Neubert, A. E., 62.
 Nevens, W. B., 16.
 Newell, P. F., 37.
 Newell, W., III, 11.
 Newlander, J. A., 66.
 Newlon, J. B., 31.
 Newlon, W. E., 5.
 Newman, C. C., 61.
 Newman, H. G., 39.
 Newman, W. S., 67.
 Newsom, I. E., 8.
 Newton, F. W., 17.
 Newton, H. D., 9.
 Newton, J. H., 8.
 Newton, J. O., 35.
 Newton, R. C., 18.
 Nicholas, J. H., 50.
- Nicholls, W. D., 26.
 Nichols, H. E., 22.
 Nichols, M. L., 1.
 Nichols, R. D., 24.
 Nicholson, J. F., 38.
 Nickell, P., 35.
 Nickels, C. B., 61.
 Nickolls, C. L., 55.
 Nierman, J. L., 38.
 Niesley, H. G., 58.
 Nightingale, G. T., 72.
 Nisonger, H. W., 52.
 Nissley, C. H., 44.
 Nissley, W. B., 58.
 Niswonger, H. R., 50.
 Nitcher, C., 24.
 Nixon, E. L., 58.
 Nixon, L. M., 49.
 Noble, C. V., 46.
 Noble, E. C., 42.
 Nobles, C. R., 67.
 Nodine, E. H., 30.
 Noer, R. D., 35.
 Nohavec, F. R., 41.
 Nolan, A. W., 16.
 Nolan, O. L., 10.
 Noland, T. W., 39.
 Noll, C. F., 57.
 Nordby, J. E., 14.
 Norris, E. B., 40.
 Norris, L. C., 48.
 Norton, E. A., 16.
 Norton, J. B. S., 29.
 Norton, W. J., 6.
 Novitski, J. F., 31.
 Nuckols, Mrs. W. W., 28.
 Nuffer, L. F., 65.
 Nungester, W. J., 27.
 Nussbaum, W. F., 20.
 Nutter, J. W., 26.
 Nye, C., 47.
- Oakes, C. W., 23.
 Oaks, C. S., 49.
 O'Brien, R., 20.
 Odland, T. E., 69.
 Ogaard, A. J., 40.
 Ogden, H. P., 62.
 Ogle, L., 53.
 Ogle, O., 63.
 Ogle, R. C., 48.
 O'Kane, W. C., 43.
 O'Kelly, J. F., 36.
 Oldenburg, F. W., 29.
 Oldis, G. J., 44.
 Oliver, A. G., 49.
 Oliver, A. W., 56.
 Oliver, C., 44.
 Oliver, J. E., 67.
 Oliver, J. G., 12.
 Olmstead, R. H., 58.
 Olney, A. J., 27.
 Olney, R. A., 70.
 Olsen, E. I., 50.

- Olson, N. E., 24.
 Olson, T. M., 62.
 Oman, A. E., 24.
 O'Neal, A. M., jr., 21.
 O'Neale, L. M., 56.
 Ong, E. R. de, 6.
 O'Roke, E. C., 62.
 O'Roke, G. W., 73.
 Orr, H. W., 55.
 Orrben, C. L., 21.
 Orton, C. R., 58.
 Osbeck, F., 35.
 Osborn, F. P., 56.
 Osborn, G. A., 44.
 Osborn, H., 53.
 Osborn, H. T., 14.
 Osborn, L. W., 4.
 Osborn, M. G., 27.
 Osborne, J. G., 65.
 Osborne, T. B., 10.
 Osburn, R. C., 53.
 Osenberg, A., 40.
 Oskamp, J., 48.
 Osmun, A. V., 31.
 Ostergaard, J. M., 13.
 Ostrander, J. E., 31.
 Ostrander, W. A., 18.
 Osuna, P., 59.
 Overbey, N., 28.
 Overholser, E. L., 7.
 Overholt, V., 52.
 Overholts, L. O., 58.
 Overley, F. L., 69.
 Overman, O. R., 16.
 Overpeck, J. C., 45.
 Overseth, O. E., 21.
 Overstreet, A. L., 61.
 Overton, M. H., 19.
 Owen, F. D., 50.
 Owen, I. L., 44.
 Owen, W. L., 28.
 Owens, C. A., 60.
 Owens, C. C., 2.
 Owens, C. E., 56.
 Owens, G. W., 68.
 Owens, J. S., 9.
 Owens, W. W., 66.
 Pack, H. J., 66.
 Paddock, F. B., 23.
 Paddock, W., 53.
 Page, E. M., 39.
 Pahau, R., 13.
 Paige, E. O., 11.
 Palmer, C. C., 10.
 Palmer, E., 19.
 Palmer, E. L., 46.
 Palmer, H. S., 13.
 Palmer, L. S., 34.
 Palmer, M., 1.
 Palmer, M. A., 8.
 Palmer, S., 4.
 Palmer, W. C., 51.
 Palmer, W. H., 52.
 Pammel, L. H., 20.
 Parfitt, E. H., 18.
 Paris, F. A., 14.
 Park, J. B., 52, 53.
 Parker, C. S., 50.
 Parker, F. W., 1.
 Parker, J. H., 23.
 Parker, J. R., 40.
 Parker, M. M., 68.
 Parker, R. L., 23.
 Parker, S. L., 5.
 Parker, S. R., 31.
 Parker, T. R., 2.
 Parkhurst, R. T., 14.
 Parks, H. B., 64.
 Parks, T. B., 49.
 Parks, T. H., 53.
 Parrish, G. R., 68.
 Parrott, P. J., 49.
 Parshall, R. L., 8.
 Parsons, D. W., 70.
 Parsons, H. T., 72.
 Parsons, J. D., 41.
 Partch, L. A., 19.
 Partridge, N. L., 33.
 Patch, E. M., 29.
 Patch, G., jr., 32.
 Patch, R. H., 9.
 Patchin, E. M., 35.
 Pate, W. F., 49.
 Paterson, A. G., 68.
 Patrick, A. L., 57.
 Patrick, C. S., 61.
 Patt, A. S., 18.
 Patt, E. M., 18.
 Patten, A. J., 32.
 Patterson, E. L., 53.
 Patterson, F. D., 68.
 Patterson, F. D., jr., 2.
 Patterson, H. J., 29.
 Patterson, M. F., 6.
 Patterson, T. M., 37.
 Patten, G. W., jr. 67.
 Pattison, F., 24.
 Patton, C. A., 53.
 Patton, L. A., 4.
 Patton, Z. B., 27.
 Patty, E., 4.
 Patty, R. L., 62.
 Paulson, W. E., 19.
 Payne, L. F., 23.
 Payne, R. F., 50.
 Payson, E. B., 73.
 Peabody, F. H., 46.
 Peabody, G. E., 47.
 Peacock, N. D., 63.
 Peairs, L. M., 70.
 Pearce, S. D., 64.
 Pearce, W. T., 51.
 Pearson, F. A., 46.
 Pearson, H. A., 51.
 Pearson, M. H., 1.
 Pearson, N., 32.
 Pearson, O., 2.
 Pearson, R. A., III, 19.
 Peck, A. L., 57.
 Peck, F. W., III, 34.
 Peck, G. W., 48.
 Peck, M., 21.
 Peckinbaugh, G., 19.
 Peitersen, A. K., 8.
 Peltier, G. L., 41.
 Pemberton, C. E., 14.
 Pence, M. O., 10.
 Pendleton, H. L., 30.
 Pennock, O. P., 8.
 Penquite, R., 54.
 Peppard, Mrs. L. L., 60.
 Perin, S. W., 42.
 Perkins, A. E., 53.
 Perkins, C. M., 25.
 Perkins, H. F., 66.
 Perkins, R. C. L., 14.
 Perkins, W. R., III, 27.
 Perley, G. A., 43.
 Perregaux, E. A., 46.
 Perrin, L. E., 28.
 Perry, E. J., 43.
 Perry, L. L., 54.
 Perry, W. M., 68.
 Persells, H. V., 12.
 Pershing, S. P., 18.
 Person, F. G., 8.
 Person, Mrs. L., 33.
 Persons, R. W., 64.
 Pessin, L. J., 37.
 Peter, A. M., 26.
 Peters, C. A., 31.
 Peters, E. M., 65.
 Peters, M. K., 41.
 Peters, W. H., 34.
 Petersen, W. E., 34.
 Peterson, A. (Minn.), 35.
 Peterson, A. (N. J.), 44.
 Peterson, A. G., 64.
 Peterson, E., 61.
 Peterson, E. G., III, 65.
 Peterson, L. I., 17.
 Peterson, V., 60.
 Peterson, W., 65.
 Peterson, W. H., 71.
 Petry, E. J., 61.
 Petry, L. C., 46.
 Pettigrove, H. R., 34.
 Pettit, R. H., 32.
 Peyton, J. C., 37.
 Phelan, J., 31.
 Phelps, E. L., 35.
 Phillips, A. G., 18.
 Phillips, C. A., 5.
 Phillips, N. E., 58.
 Phillips, S. W., 12.
 Phillips, T. G., 52.
 Philp, G. L., 7.
 Phinney, G. H., 23.
 Phipps, C. R., 39.
 Pickard, S., 24.
 Pickens, E. M., 29.
 Pickett, B. S., 22.
 Pickett, F. L., 28.
 Pickett, W. F., 25.
 Pickrell, C. U., 3.
 Piedalue, I. M., 27.
 Pieper, J. J., 16.
 Pierce, H. B., 58.
 Pierson, C. J., 29.
 Pierson, E., 62.
 Pilchard, E. I., 16.

- Pilkey, A. M., 36.
 Pillsbury, J. P., 50.
 Pinckney, R. M., 36.
 Pinckney, S. M., 61.
 Pirnie, M. D., 48.
 Pittman, B. C., 66.
 Pittman, D. W., 65.
 Pittman, E. E., 46.
 Pittman, M. S., 25.
 Plagge, H. H., 22.
 Plagge, H. J., 22.
 Plantevigne, L., 4.
 Plice, M. J., 18.
 Plumb, C. S., 52.
 Plunkett, C., 4.
 Poelma, L. J., 29.
 Polk, T. P., 26.
 Pollard, E. F., 1.
 Pollock, E. O., 64.
 Pollock, J. S., 55.
 Polson, M. E., 25.
 Pond, G. A., 34.
 Pontius, B. E., 18.
 Pool, R. J., 41.
 Poole, R. F., 43, 44.
 Pope, J. P., 42.
 Pope, W. T., 14.
 Popp, H. W., 58.
 Porter, A. L., 39.
 Porter, C. L., 18.
 Porter, D. R., 20.
 Porter, J. P., 48.
 Posson, M. B., 41.
 Post, R. E., 62.
 Potter, A. A., 17.
 Potter, C. E., 40.
 Potter, E. L., 55.
 Potter, G. F., 43.
 Potter, L. C., 61.
 Potter, L. M., 66.
 Potter, P. B., 52.
 Potts, A. T., 64.
 Potts, H. C., 54.
 Pound, G. H., 44.
 Powell, C. K., 48.
 Powell, E. B., 39.
 Powell, P. P., 1.
 Powell, S. V., 37.
 Powers, E. B., 63.
 Powers, W. L., 57.
 Pratt, B. A., 55.
 Pratt, D. J., 64.
 Pratt, F. R., 44.
 Pratt, J. S. B., jr., 14.
 Prentice, B. N., 19.
 Prentiss, S. W., 56.
 Pressley, E. H., 3.
 Preston, C. M., 8.
 Prettyman, H. W., 70.
 Prevost, E. S., 61.
 Prewitt, J. D., 64.
 Prewitt, E. M., 26.
 Prillerman, D. M., 70.
 Prillerman, E., 70.
 Price, C. B., 67.
 Price, E. R., 67.
 Price, F. E., 57.
 Price, H. B., 35.
 Price, H. L., 67.
 Price, J. C. C., 37.
 Price, M., 52.
 Price, O. B., 33.
 Price, R. B., jr., 39.
 Price, W. A., 18.
 Price, W. V., 46.
 Prince, A. H., 65.
 Prince, A. L., 43.
 Pritchard, S. R., 67.
 Pritchett, L., 55.
 Proctor, E. E., 12.
 Proebsting, E. L., 7.
 Proulx, E. G., 18.
 Frucha, M. J., 16.
 Przuluska, W., 53.
 Publow, H. L., 33.
 Pugsley, C. W., 61.
 Pulley, M. C., 30.
 Purcell, M., 72.
 Purves, C. M., 64.
 Puryear, C., 63.
 Pushee, G. F., 31.
 Putnam, G. W., 34.
 Putnam, P. L., 9.
 Pyle, N. J., 31.
 Pyrtle, R. N., 55.
 Quaife, E. L., 20.
 Quayle, H. J., 6.
 Quayle, W. L., 73.
 Quesenberry, G. R., 45.
 Quinn, J. T., 39.
 Quisenberry, K. S., 69.
 Quist, J. S., 21.
 Raburn, G. E., 25.
 Radspinner, W. A., 50.
 Raeder, J. M., 15.
 Raffetto, L. A., 5.
 Ragsdale, A. C., 38.
 Rainey, D. F., 33.
 Raleigh, G. J., 31.
 Ralston, G. S., 67.
 Ralston, W. R., 6.
 Ramirez, J. H., 59.
 Ramos, R. M., 59.
 Ramsower, H. C., III, 52.
 Randlett, G. W., 50.
 Randolph, E. E., 49.
 Randolph, E. O., 64.
 Randolph, F. R., 46.
 Randolph, J. W., 1.
 Raney, E. R., 50.
 Rankin, F. H., 16.
 Rankin, J. O., 41.
 Rankin, W. H., 48.
 Rapping, A. H., 70.
 Rapp, C. W., 4.
 Rasmussen, M. P., 46.
 Rathbone, R. V., 12.
 Rather, H. C., 33.
 Rauchenstein, E., 17.
 Raven, M. I., 44.
 Rawl, E. H., 61.
 Rea, H. E., 64.
 Rea, J. L., jr., 50.
 Read, J. W., 4.
 Reade, J. M., 12.
 Rearden, J. H., 15.
 Rebrasser, R., E., 53.
 Recknagel, A. B., 47.
 Records, E., 42.
 Redd, H. B., 67.
 Reddick, D., 46.
 Redditt, J. R., 20.
 Redfield, K. T., 62.
 Redman, R. W., 31.
 Reed, C. O., 52.
 Reed, E. P., 52.
 Reed, E. T., 57.
 Reed, F. P., 21.
 Reed, H. D., 48.
 Reed, H. E., 24.
 Reed, H. J., 17.
 Reed, H. S., (Calif.), 5.
 Reed, H. S. (Mich.), 32.
 Reed, O. E., 32.
 Reed, R. C., 29.
 Reed W. D., 61.
 Reeder, G., 39.
 Reeder, W. C., 50.
 Rees, C. W., 66.
 Reese, H. M., 39.
 Reese, N. M., 12.
 Reeve, L. P., 73.
 Reeves, O. G., 56.
 Regan, M. J., 38.
 Regan, W. M., 5.
 Regeimbal, L. O., 36.
 Regenbrecht, E. M., 64.
 Regt, A. C. de, 43.
 Reid, D. H., 64.
 Reid, T. R., 4.
 Reid, W. H. E., 38.
 Reider, E. S., 58.
 Reimer, F. C., 57.
 Reinhard, H. J., 64.
 Reitz, W. W., 12.
 Remington, R. E., 51.
 Remund, R., 55.
 Renner, K. M., 24.
 Reppert, R. R., 64.
 Ressler, I. L., 23.
 Rettger, L. F., 9.
 Reyna, J. E., 46.
 Reynolds, E. A., 47.
 Reynolds, E. B., 63.
 Reynolds, E. S., 51.
 Reynolds, H., 2.
 Reynolds, L. W., 31.
 Reynolds, M. H., 36.
 Reynolds, P. M., 51.
 Rhoads, A. S., 11.
 Rhoads, W., 26.
 Rhode, C. S., 16.
 Rhode, E. F., 17.
 Rhodes, A. M., 55.
 Rhue, L. C., 17.
 Rice, C. D., 23.
 Rice, J. E., 48.
 Rice, Mrs. M. A., 41.
 Rice, V. A., 30.

- Rice, W. H., 29.
 Rice, W. S., 12.
 Rich, F. A., 66.
 Richards, B. L., 65.
 Richards, G., 72.
 Richards, L., 35.
 Richardson, A. E., III, 21.
 Richardson, A. G. G., 12.
 Richardson, A. W., 42.
 Richardson, B. T., 1.
 Richardson, C. S., 29.
 Richardson, D. W., 8.
 Richardson, E., 22.
 Richardson, E. H., 22.
 Richardson, J., 35.
 Richardson, L., 66.
 Richardson, L. A., 62.
 Richardson, M. B., 22.
 Richardson, P., 59.
 Richey, H. W., 22.
 Richman, E., 58.
 Richmond, R. G., 64.
 Richmond, T. E., 16.
 Ricks, Mrs. G. S., 55.
 Ricks, J. R., 36, 37.
 Riddell, F. T., 32.
 Riddell, G. R., 1.
 Riddick, W. C., 49.
 Riemenschneider, A., 22.
 Ries, V. H., 19.
 Riggs, A. G., 22.
 Riggs, W. M., III.
 Riley, H. W., 46.
 Riley, J. A., 61.
 Riley, M. C., 71.
 Riley, P. G., 18.
 Riley, W. A., 35.
 Rilling, H. E., 51.
 Rimoldi, F. J., 53.
 Rinehart, E. F., 14.
 Ripley, G. E., 4.
 Ripperton, J. C., 14.
 Rishoi, A. H., 68.
 Ritchie, W. S., 38.
 Ritz, F., 10.
 Ritzman, E. G., 42.
 Rivera, A., 59.
 Rivers, A. H., 11.
 Roach, C., 45.
 Roach, C. E., 22.
 Roadhouse, C. L., 5.
 Robb, B. B., 46.
 Robbers, W. R., 44.
 Robbins, E. T., 16.
 Robbins, F. E., 18.
 Robbins, W. J., 38.
 Robbins, W. R., 44.
 Robbins, W. W., 5.
 Robert, J. C., 36.
 Robert, S. A., 63.
 Roberts, E., 16.
 Roberts, G., 26.
 Roberts, G. H., 19.
 Roberts, L. E., 3.
 Roberts, M., 22.
 Roberts, O. S., 18.
 Roberts, R., 47.
 Roberts, R. E., 52.
 Roberts, R. H., 72.
 Robertson, A. H., 48.
 Robertson, D. J., 73.
 Robertson, D. W., 7.
 Robertson, J. H., 63.
 Robertson, L. S., 19.
 Robertson, W. F., 31.
 Robertson, W. R. B., 39.
 Robey, O. E., 33.
 Robichaux, F. J., 27.
 Robinson, A., 2.
 Robinson, A. B., 16.
 Robinson, C. P., 38.
 Robinson, C. S., 32.
 Robinson, C. W., 62.
 Robinson, E. P., 43.
 Robinson, F. H., 60.
 Robinson, J. L., 21.
 Robinson, J. M., 2.
 Robinson, M., 47.
 Robinson, M. E., 39.
 Robinson, Mrs. O., 63.
 Robinson, R. H., 56.
 Robison, W. L., 53.
 Robotka, F., 21.
 Robson, H. K., 69.
 Rochefort, J. M., 39.
 Rockhill, M., 22.
 Rockwell, E. H., 43.
 Rodenwold, B. W., 56.
 Roderick, L. M., 51.
 Rodier, E. A., 69.
 Rodolfo, A., 72.
 Rodriguez, J. G., 40.
 Roe, H. B., 35.
 Roehl, L. M., 47.
 Rofkar, W. F., 54.
 Rogers, C. E., 25.
 Rogers, F., 11.
 Rogers, H. S., 56.
 Rogers, H. W., 54.
 Rogers, J. H., 64.
 Rogers, J. S., 11.
 Rogers, M. H., 33.
 Rogers, R. W., 31.
 Rogers, W. B., 60.
 Rokahr, M., 73.
 Roller, E. M., 20.
 Romaine, J. D., 57.
 Root, A. D., 39.
 Rosa, J. T., jr., 7.
 Rose, E. J., 9.
 Rose, F., 47.
 Rose, R. C., 36.
 Roseboom, B. B., 33.
 Rosen, H. R., 4.
 Rosenkrans, D. B., 60.
 Rosewall, O. W., 28.
 Ross, B. B., 1.
 Ross, C. S., 65.
 Ross, G. R., 50.
 Ross, H. A., 46.
 Ross, H. E., 46.
 Ross, P. H., 3.
 Ross, R. C., 17.
 Rot, C. O., 36.
 Rothacker, R. R., 22.
 Rowan, L. J., 38.
 Rowe, H. B., 21.
 Rowland, O. W., 4.
 Rowlands, W. A., 71.
 Rubel, C. W., 6.
 Ruby, P. E., 25.
 Rude, C. S., 64.
 Rudnick, A. W., 20.
 Rudolf, W., 44.
 Rudolph, B. A., 7.
 Ruehe, H. A., 16.
 Ruehle, G. L. A., 33.
 Ruffner, R. H., 49.
 Ruggles, A. G., 35.
 Rumsey, W. E., 70.
 Runk, C. R., 10.
 Runnalls, W. J., 41.
 Runnells, R. A., 34.
 Rupp, G. F., 58.
 Ruprecht, R. W., 11.
 Rusk, H. P., 16.
 Russ, E. M., 7.
 Russel, J. C., 41.
 Russell, F. L., 28.
 Russell, G. P., 27.
 Russell, H. L., III, 71.
 Russell, M., 22.
 Ruth, C. C., 56.
 Ruth, W. A., 17.
 Rutherford, E., 41.
 Ruzek, C. V., 57.
 Ryan, E., 33.
 Ryan, J. C., 37.
 Ryan, M., 42.
 Rynerson, H. Z., 21.
 Sachs, W. H., 4.
 Sackett, R. L., 57.
 Sackett, W. G., 8.
 St. John, H., 68.
 St. John, J. L., 68.
 Saldana, J. A., 59.
 Sales, E. K., 34.
 Salisbury, S. M., 52.
 Salmon, S. C., 23.
 Salmon, W. D., 1.
 Salter, R. M., 53.
 Sammis, J. L., 71.
 Sampson, A. W., 6.
 Sampson, H. C., 52.
 Sampson, H. O., 43.
 Sams, C. L., 50.
 Samuels, E. L., 22.
 Sanborn, C. E., 55.
 Sanborn, M. L., 43.
 Sanborn, N. W., 11.
 Sanborn, R., 30.
 Sanctuary, W. C., 30.
 Sand, A. W. W., 48.
 Sanders, D. A., 26.
 Sanders, O. W., 38.
 Sanders, W. H., 24.
 Sanderson, E. D., 46.
 Sanderson, H. M., 62.
 Sanderson, T., 50.
 Sandhouse, H. A., 4.
 Sandstedt, R. M., 41.

- Sandsten, E. P., 8.
 Sanmann, F. P., 16.
 Sargent, C. G., 8.
 Sargent, E. L., 43.
 Sattler, A. M., 22.
 Saunders, A. A., 72.
 Saunders, C. W., 20.
 Saunders, W. D., 67.
 Sauve, E. C., 33.
 Savage, E. S., 46.
 Saville, R. J., 50.
 Savoy, W. F., 70.
 Sawtelle, D. W., 31.
 Sawyer, C. E., 25.
 Sax, K., 28.
 Saye, G. P., 12.
 Sayre, C. B., 17.
 Sayre, J. D., 52.
 Scanlan, R. W., 16.
 Scarbro, P. J., 62.
 Schaedel, J. M., 65.
 Schaefer, O. G., 34.
 Schafer, E. G., 69.
 Schafer, R. W., 8.
 Schaffer, O. G., 17.
 Schaffner, J. H., 52.
 Schairer, E. S., 72.
 Schalk, A. F., 51.
 Scherer, N. W., 53.
 Schermerhorn, L. G., 44.
 Schierz, E. R., 73.
 Schilleter, A. E., 61.
 Schilleter, J. C., 22.
 Schilling, S. J., 4.
 Schlundt, H., 38.
 Schmidt, D., 44.
 Schmidt, E. G., 71.
 Schmidt, G. A., 8.
 Schmidt, H., 65.
 Schmidt, R., 50.
 Schmitz, H., 15.
 Schmitz, N., 57.
 Schneck, H. W., 48.
 Schneiderhan, F. J., 67.
 Schoene, W. J., 67.
 Scholes, B. E., 19.
 Scholl, E. E., 55.
 Schollenberger, C. J., 53.
 Schoonover, W. R., 7.
 Schoth, A. J., 23.
 Schoth, H. A., 56.
 Schowengerdt, P. F., 39.
 Schrack, C. V., 15.
 Schrader, A. L., 30.
 Schramm, J. R., 46.
 Schrass, M. E., 19.
 Schulz, J. A., 20.
 Schumacher, F. X., 6.
 Schumaker, D., 47.
 Schuster, C. E., 57.
 Schuster, G. L., 10.
 Schutt, C. D., 46.
 Schwab, J. W., 18.
 Schwalen, H. C., 3.
 Schwantes, A. J., 35.
 Schwartz, L. H., 18.
 Schwenker, M., 72.
 Scoates, D., 64.
 Scott, D. M., 68.
 Scott, I. T., 38.
 Scott, J. M., 11.
 Scott, J. P., 25.
 Scott, J. W. (Mich.), 32.
 Scott, J. W. (Wis.), 73.
 Scott, R. C., 12.
 Scott, R. J., 47.
 Scott, S. G., 40.
 Scott, V. E., 42.
 Scott, W., 56.
 Scott, W. H., 60.
 Scoville, G. P., 46.
 Scudder, H. D., 56.
 Scullen, H. A., 56.
 Seal, J. L., 36.
 Seamans, A. E., 40.
 Searles, H. R., 34.
 Sears, F. C., 31.
 Sears, G. W., 42.
 Sears, O. H., 16.
 Sears, W. R., 53.
 Seaton, J. P., 18.
 Seaton, M. A., 38.
 Seaton, R. A., III, 23.
 Sebastian, M. R., 28.
 Secrest, E., 54.
 Secrest, M., 6.
 Seeley, D. A., 33.
 Sein, F., jr., 59.
 Seitz, C. E., 67.
 Selby, Mrs. E. P., 2.
 Selby, H. E., 40.
 Sell, I., 35.
 Sellards, H. G., 26.
 Sellers, J. E., 24.
 Sellman, R. L., 29.
 Selvig, C. G., 36.
 Sequist, M., 25.
 Serex, P., jr., 31.
 Setchell, W. A., 5.
 Settle, O., 22.
 Severance, G., 69.
 Severin, H. C., 62.
 Severin, H. H. P., 6.
 Severin, J. E., 12.
 Severson, A. S., 51.
 Sewall, H. W., 36.
 Sewell, J. G., 6.
 Sewell, M. C., 23.
 Sexauer, T. E., 38.
 Seymour, H. C., 56.
 Shafer, F. F., 70.
 Shaffer, J. H., 70.
 Shank, D., 56.
 Shanklin, F. M., 19.
 Sharfenstein, G. I., 9.
 Sharp, L. W., 46.
 Sharp, P. F., 40.
 Shattuck, O., 57.
 Shaw, C. F., 5.
 Shaw, E. L., 70.
 Shaw, J. K., 31.
 Shaw, J. M., 20.
 Shaw, R. S., 32.
 Shaw, S. B., 30.
 Shaw, W. M., 63.
 Shaw, W. T., 69.
 Shawl, R. I., 17.
 Shay, W. W., 49.
 Shealy, A. L., 11.
 Shear, E. V., jr., 48.
 Shear, S. W., 6.
 Shearer, P. S., 20.
 Shedd, O. M., 26.
 Sheffer, L. M., 12.
 Sheldon, F. M., 20.
 Shellenberger, M., 33.
 Shelton, F. C., 60.
 Shelton, W. R., 55.
 Shepard, C. E., 10.
 Shepardon, C. N., 8.
 Shepherd, H. W., 7.
 Shepperd, J. H., 51.
 Sherbakoff, C. D., 62.
 Sheridan, M. E., 8.
 Sherman, F., jr., 50.
 Sherman, J. M., 46.
 Sherman, L. P., 25.
 Sherwood, E. C., 70.
 Sherwood, F. F., 20.
 Sherwood, F. W., 49.
 Sherwood, R. C., 34.
 Sherwood, R. M., 64.
 Shibles, L. H., 29.
 Shields, F. M., 54.
 Shigley, J. F., 57.
 Shilling, I. M., 22.
 Shirky, S. B., 39.
 Shive, J. W., 43.
 Shobe, W. L., 27.
 Shoemaker, J. N., 53.
 Short, A. K., 64.
 Shoup, G. R., 69.
 Shoup, Mrs. G. R., 69.
 Shrader, H. L., 38.
 Shuey, G. A., 58.
 Shuhart, D. V., 55.
 Shumaker, G., 50.
 Shunk, I. V. D., 49.
 Sibley, C. K., 47.
 Sibley, F. H., 42.
 Siehler, I. M., 32.
 Sidelmann, I. O., 58.
 Siecke, E. O., 64.
 Siemens, M. M., 69.
 Sievers, F. J., 69.
 Silkett, R. J., 39.
 Simmons, G. E., 28.
 Simmons, J. E., 56.
 Simmons, S. B., 2.
 Simms, B. T., 57.
 Simms, H., 2.
 Simms, J. A., 9.
 Simon, R. H., 53.
 Simons, L. R., 47.
 Simons, P. T., 1.
 Simpson, A. C., 58.
 Simpson, F., 12.
 Sims, A. J., 63.
 Sims, M. L., 2.
 Sims, N. L., 31.
 Sims, S. D., 71.
 Sinclair, W., 29.

- Singleton, H. P., 69.
 Sinkford, M., 70.
 Sinnott, E. W., 9.
 Sipe, G. R., 37.
 Sippel, O. A., 40.
 Sisk, T. K., 60.
 Sisson, S., 53.
 Sjogren, J. W., 8.
 Sjogren, O. W., 41.
 Skelley, W. C., 43, 44.
 Skelton, G. V., 56.
 Skidmore, L. V., 42.
 Skidmore, R., 66.
 Skillman, E. G., 44.
 Skinner, A. G., 9.
 Skinner, E. L., 31.
 Skinner, J., 2.
 Skinner, J. H., III, 17.
 Skinner, L. T., 41.
 Slagg, C. M., 10.
 Slate, G. L., 49.
 Slate, W. L., jr., 9, 10.
 Slightam, K., 63.
 Slipher, J. A., 53.
 Sloat, H. S., 58.
 Slocum, B. A., 69.
 Small, D., 16.
 Smith, A., 5.
 Smith, A. B., 25.
 Smith, A. C., 34.
 Smith, A. G., jr., 67.
 Smith, A. M., 22.
 Smith, B. B., 24.
 Smith, C. O., 7.
 Smith, C. R., 22.
 Smith, C. W., 41.
 Smith, D. N., 23.
 Smith, E. D., 8.
 Smith, E. E., 58.
 Smith, E. F., 8.
 Smith, E. H., 7.
 Smith, E. T., 51.
 Smith, F. E., 15.
 Smith, F. H., 13.
 Smith, G. E. P., 3.
 Smith, G. M., 18.
 Smith, G. O., 29.
 Smith, H., 66.
 Smith, H. B., 28.
 Smith, H. C., 28.
 Smith, H. G., 49.
 Smith, H. H., 8.
 Smith, H. J., 37.
 Smith, H. P., 64.
 Smith, H. S., 6.
 Smith, H. W., 29.
 Smith, I. M., 69.
 Smith, J. B., 60.
 Smith, J. E., 30.
 Smith, L. B., 6.
 Smith, L. H., 16.
 Smith, L. J., 68.
 Smith, L. R., 12.
 Smith, M., 53.
 Smith, M. E., 72.
 Smith, M. M. (N. H.), 43.
 Smith, M. M. (Oreg.), 56.
 Smith, M. Van G., 10.
 Smith, O. M., 55.
 Smith, P. H., 31.
 Smith, R., 51.
 Smith, R. C., 24.
 Smith, R. E., 7.
 Smith, Mrs. R. G., 47.
 Smith, R. S., 16.
 Smith, R. T., 68.
 Smith, R. W., jr., 30.
 Smith, T. O., 43.
 Smith, W. E., 14.
 Smith, W. H., 16.
 Smith, W. S., 27.
 Smith, W. W., 18.
 Smith, Z. M., 19.
 Smyth, J. R., 26.
 Snapp, R. R., 16.
 Snell, M. G., 45.
 Snider, H. J., 16.
 Snipes, M. L., 2.
 Snodgrass, G. L., 27.
 Snodgrass, M. D., 3.
 Snook, J. H., 53.
 Snow, F. L., 57.
 Snyder, E. M., 26.
 Snyder, G. B., 31.
 Snyder, J. M., 30.
 Snyder, R. M., 34.
 Snyder, R. S. (Idaho), 14.
 Snyder, R. S. (Pa.), 58.
 Snyder, R. W., 20.
 Snyder, S. D., 64.
 Snyder, W. P., 42.
 Soby, L., 35.
 Sommer, H. H., 71.
 Sonnenday, D. F., 1.
 Sotola, J., 68.
 Soule, A. M., 12.
 Soule, R. M., 12.
 Spaeth, C. P., 43.
 Spangler, R. L., 14.
 Spangler, S. M., 62.
 Sparks, E. E., 17.
 Spaulding, M. H., 40.
 Spears, H. D., 27.
 Spencer, A. P., 11.
 Spencer, F. W., 27.
 Spencer, H., 68.
 Spencer, H. B., 51.
 Spencer, J. N., 20.
 Spencer, J. O., 30.
 Spencer, L., 46.
 Spencer, R., 22.
 Spencer, V. E., 16.
 Sperry, A. B., 25.
 Spieth, A. J., 64.
 Spinney, L. B., 22.
 Spitler, J. C., 16.
 Spitzer, G., 18.
 Spohn, A., 47.
 Spohn, B. B., 52.
 Spragg, F. A., 33.
 Sprague, H. B., 43, 44.
 Sprague, M. E., 9.
 Spriggs, Mrs. A. D., 70.
 Spring, S. N., 47.
 Springer, J. R., 11.
 Spuler, A., 69.
 Spurrier, F. M., 6.
 Spurway, C. H., 33.
 Stack, J. W., 34.
 Stacy, W. H., 21.
 Stadler, L. J., 39.
 Stafford, E. W., 37.
 Stafseth, H. J., 34.
 Stahl, J. L., 7.
 Stakman, E. C., 26.
 Staley, F. M., 61.
 Stallings, J. H., 64.
 Stallings, M., 39.
 Stanford, K. M., 58.
 Stange, C. H., 23.
 Stangel, W. L., 54.
 Stanley, E. B., 3.
 Stanley, L., III.
 Stanley, L. M., 51.
 Stannard, B. E., 47.
 Staples, C. H., 27.
 Staples, R., 41.
 Stapley, T. L., 3.
 Stark, R. W., 16.
 Starke, R. R., 43.
 Starkey, L. V., 60.
 Starkey, R. L., 43, 44.
 Starnes, T. S., 67.
 Starr, G. E., 33.
 Starr, S. H., 13.
 Starrak, J. A., 21.
 Starring, C. C., 40.
 Stearns, L. A., 67.
 Steele, B., 41.
 Steele, D. G., 72.
 Steele, H., 63.
 Steelman, L. W., 57.
 Steenbock, H., 71.
 Steffen, E. H., 69.
 Steiger, E., 53.
 Steinel, A. T., 8.
 Steiner, A. J., 26.
 Steiner, R., 32.
 Steinmetz, F. H., 34.
 Stemmons, W., 9.
 Stender, H. K., 14.
 Stone, A. E., 59.
 Stephens, D. E., 57.
 Stephens, M., 22.
 Stephenson, N. M., 19.
 Stephenson, R. E., 57.
 Stephenson, R. S., 20.
 Steup, H. H., 24.
 Steve, N. D., 47.
 Stevens, A. T., 9.
 Stevens, B. W., 56.
 Stevens, C. L., 43.
 Stevens, F. D., 27.
 Stevens, H., 72.
 Stevens, H. B., 43.
 Stevens, J. W., 71.
 Stevens, O. A., 51.
 Stevenson, F. J., 61.
 Stevenson, G. L., 61.
 Stevenson, H. A., 48.
 Stevenson, R. A., 26.

- Stevenson, W. H., 21.
 Stewart, E. A., 35.
 Stewart, F. C., 48.
 Stewart, G., 65.
 Stewart, G. R., 14.
 Stewart, H. W., 72.
 Stewart, J. J., 41.
 Stewart, O. M., 39.
 Stewart, P. H., 41.
 Stewart, R., 42.
 Stewart, R. M., 46.
 Stewart, S., 28.
 Stewart, W. F., 52.
 Stiles, H., 23.
 Stillman, G. S., 72.
 Stillman, H. A., 39.
 Stillwell, E. C., 70.
 Stillwell, M. E., 42.
 Stiritz, B. A., 16.
 Stirniman, E. J., 6.
 Stivers, E. D., 1.
 Stoa, T. E., 51.
 Stockdale, C. E., 70.
 Stocking, W. A., 46.
 Stoddard, E. M., 10.
 Stoddard, L., 35.
 Stokdyk, E. A., 24.
 Stokes, W. E., 11.
 Stoltz, R. B., 52.
 Stone, A. L., 71.
 Stone, H. C., 37.
 Stone, P. H., 13.
 Storer, T. I., 6.
 Storie, R. E., 5.
 Storm, A. V., 35.
 Stouder, K. W., 23.
 Stout, S. R., 4.
 Stoutamire, R., 11.
 Stover, W. G., 52.
 Strahan, C. M., 12.
 Strahan, J. L., 31.
 Stratton, R., 54.
 Strawn, O. P., 67.
 Streeter, L. R., 49.
 Streets, R. B., 72.
 Strickland, Mrs. E. E., 46.
 Strickland, G., 56.
 Stroman, G. N., 63.
 Strong, A. J., 11.
 Strowd, W. H., 71.
 Stubblefield, D. A., 15.
 Stuckey, H. P., 13.
 Studley, L. A., 35.
 Stuppy, G. W., 64.
 Sturgis, N. H., 55.
 Sturkie, D. G., 60.
 Suarez, E., 2.
 Sugg, R. S., 2.
 Sullins, D. G., 13.
 Sullivan, K. C., 38.
 Summerour, C. W., 12.
 Summers, O. N., 41.
 Summers, T. H., 8.
 Sumner, H. R., 23.
 Sumner, W. A., 72.
 Sunderlin, H. H., 21.
 Sure, B., 4.
 Surr, J. G., 7.
 Sussex, S. W., 62.
 Sutherland, M. E., 69.
 Sutter, C. M., 61.
 Sutton, J. A., 54.
 Sutton, L. F., 70.
 Swallow, A. P., 65.
 Swanson, A. F., 25.
 Swanson, C. O., 23.
 Swanson, H. B., 21.
 Swartwout, H. G., 39.
 Sweeney, M. P., 49.
 Sweeny, M. E., 27.
 Sweet, M. B., 15.
 Sweetser, H. P., 29.
 Swenehart, J. H., 71.
 Swenk, M. H., 41.
 Swezey, O. H., 14.
 Swift, H. C., 28.
 Swift, R. W., 59.
 Swingle, D. B., 40.
 Swire, R. P., 28.
 Swope, W. D., 58.
 Symons, T. B., III, 29.
 Szymoniak, B., 28.
 Taber, R. F., 52.
 Tabor, A., 13.
 Tabor, P., 12.
 Taff, P. C., 21.
 Taggart, W. G., 28.
 Tague, E. L., 24.
 Tailby, G. W., jr., 46.
 Talbert, T. J., 39.
 Talbot, N. A., 55.
 Talbot, R. F., 28.
 Talcott, A., 21.
 Taliaferro, W. T. L., 30.
 Tanner, H. T., 38.
 Tanner, J. E., 37.
 Tannreuther, G. W., 39.
 Tanquary, M. C., 64.
 Tapley, W. T., 58.
 Tappan, G., 1.
 Tarr, L. W., 10.
 Tarr, W. A., 39.
 Tate, E. I., 68.
 Taubenhous, J. J., 65.
 Tavernetti, T. F., 5.
 Taylor, A. D., 53.
 Taylor, B. L., 15.
 Taylor, C. A., 47.
 Taylor, C. C. (N. C.), 50.
 Taylor, C. C. (Va.), 67.
 Taylor, C. M., 60.
 Taylor, D., 20.
 Taylor, D. B., 2.
 Taylor, D. J., 24.
 Taylor, D. M., 22.
 Taylor, E. L., 41.
 Taylor, E. T., 37.
 Taylor, F. W., 42.
 Taylor, G. S., 34.
 Taylor, J. B., 62.
 Taylor, J. C. (Conn.), 9.
 Taylor, J. C. (Mont.), 40.
 Taylor, L. C., 56.
 Taylor, L. W., 24.
 Taylor, O. A., 34.
 Taylor, O. M., 49.
 Taylor, W. A., III.
 Teague, J. E., 64.
 Tear, J., 33.
 Tegner, C. E., 5.
 Temple, C. E., 30.
 Templeton, G. S., 36.
 Templin, E., 65.
 Tennant, H., 32.
 Terrell, W. G., 27.
 Terrill, B. M., III, 66.
 Terry, J., 26.
 Terry, O. P., 18.
 Test, L. A., 18.
 Tetrault, P. A., 18.
 Tetreau, E., 71.
 Thaden, J. F., 21.
 Thatcher, L. E., 53.
 Thatcher, R. W., III, 45, 48.
 Thayer, C. H., 30.
 Thayer, C. L., 31.
 Thayer, D. C., 21.
 Thayer, P., 58.
 Thayer, W. C., 30.
 Thelin, G. A., 30.
 Theus, J. H., 28.
 Thomas, DeR., 3.
 Thomas, E. C., 14.
 Thomas, E. E., 6.
 Thomas, F. L., 2.
 Thomas, H. E., 48.
 Thomas, J. L., 64.
 Thomas, J. M., III, 57.
 Thomas, M. D., 65.
 Thomas, M. E., 28.
 Thomas, R. C., 53.
 Thomas, R. P., 16.
 Thomas, R. S., 18.
 Thomas, W., 58.
 Thomasson, R. R., 39.
 Thompson, B. E., 32.
 Thompson, C. H., 31.
 Thompson, C. P., 54.
 Thompson, D. M., 18.
 Thompson, E. J., 51.
 Thompson, F., 63.
 Thompson, G. E., 23.
 Thompson, H., 1.
 Thompson, H. C., 47.
 Thompson, J. B., 68.
 Thompson, J. W., 35.
 Thompson, M. J., 35, 36.
 Thompson, O. A., 51.
 Thompson, R. B., 54.
 Thompson, R. C., 8.
 Thompson, S. H., 21.
 Thompson, T. J., 41.
 Thompson, W. C., 43, 44.
 Thompson, W. O., 52.
 Thomsen, F. L., 71.
 Thomsen, L. C., 71.
 Thone, F., 11.
 Thor, A. U., 16.
 Thorfinnson, T. S., 51.
 Thorner, H., 40.

- Thornber, J., 15.
 Thornber, J. J., 3.
 Thorne, C. E., 54.
 Thornton, M. H., 18.
 Thorp, K., 48.
 Thorp, W. P., jr., 43, 44.
 Thrash, C. L., 53.
 Throckmorton, R. I., 23.
 Thurston, A. S., 30.
 Thurston, F. M., 47.
 Thurston, H. W., jr., 58.
 Thurston, M. F., 46.
 Tidmore, J. W., 1.
 Tiebout, G. L., 28.
 Tiedjens, V. A., 31.
 Tiffany, E. M., 71.
 Tiffany, L. H., 52.
 Tilford, P. E., 53.
 Timberlake, P. H., 14.
 Tippet, J. E., 6.
 Tirrell, L. V., 42.
 Tisdale, H. B., 1.
 Tisdale, W. B., 11.
 Tittler, R. P., 60.
 Titus, C. M., 6.
 Titus, H. W., 45.
 Titus, R. W., 24.
 Tobey, E. R., 29.
 Tobey, G. N., 62.
 Tobiska, J. W., 8.
 Todd, A. E., 16.
 Todd, C. C., 68.
 Tomhave, A. E., 10.
 Tomhave, W. H., 57.
 Tompkins, C. M., 8.
 Tomson, W. E., 5.
 Torgerson, E. F., 57.
 Toro, R. A., 59.
 Torrance, J. B., 35.
 Torrence, Mrs. H. S., 61.
 Torrey, E. C., 36.
 Torrey, G. S., 9.
 Torrey, R. E., 31.
 Totman, C. C., 62.
 Tottingham, W. E., 71.
 Trabue, E., 9.
 Tracy, P. H., 16.
 Trail, R. K., 70.
 Transeau, E. N., 52.
 Traum, J., 7.
 Treakle, A. F., 67.
 Treakle, R. F., 67.
 Treat, N., 35.
 Tretsven, J. O., 40.
 Trice, M. F., 49.
 Trimble, R. E., 8.
 Troop, J., 18.
 Frost, J. F., 18.
 Trotter, F. B., 69.
 Trotter, I. P., 39.
 Trotter, J. W., 50.
 Trout, G. M., 70.
 Trowbridge, E. A., 38.
 Trowbridge, P. F., 50.
 Troy, H. C., 46.
 True, A. C., III.
 True, G. H., 5.
 Truitt, R. V., 29.
 Trull, F. W., 33.
 Truog, E., 72.
 Tubby, E., 8.
 Tucker, B., 73.
 Tucker, C. M., 59.
 Tucker, D. A., 67.
 Tucker, M. L., 31.
 Tucker, R. D., 68.
 Tuckwiller, R. H., 70.
 Tufts, W. P., 7.
 Tukey, H. B., 49.
 Tunnicliff, E. A., 16.
 Turlington, J. E., 11.
 Turnbow, G. D., 5.
 Turneure, F. E., 71.
 Turner, A. A. (Fla.), 11.
 Turner, A. A. (N. C.), 50.
 Turner, A. W., 21.
 Turner, C. W., 38.
 Turner, J. D., 27.
 Turner, L. G., 58.
 Turner, M. E., 22.
 Turner, N., 38.
 Turner, R. A., 32.
 Turner, R. M., 69.
 Turner, V. C., 2.
 Twitchell, H. P., 52.
 Tyler, A. G., 35.
 Tynes, J. B., 68.
 Tyson, J., 33.
 Ufford, O. C., 8.
 Uhland, R. E., 39.
 Ullsperger, H. W., 72.
 Umberger, H. J. C., 23.
 Underhill, G. W., 67.
 Underwood, F. O., 48.
 Underwood, W. W., 69.
 Upham, A. H., 14.
 Upp, C., 54.
 Upson, F. W., 41.
 Ure, R., 36.
 Utz, E. J., 52.
 Uyei, N., 16.
 Vail, C. E., 8.
 Valentine, G. H., 61.
 Valle, M. A. del, 59.
 Valteau, W. D., 26.
 Van Aken, K. G., 17.
 Van Alstine, E., 66.
 Vanatta, E. E., 38.
 Vanatter, P. O., 12.
 Van Brocklin, F. R., 14.
 Vandecaveye, S. C., 68.
 van der Meulen, P. A., 43.
 Vandervort, H. S., 70.
 Vandervort, J., jr., 48.
 Van Dine, D. L., 58.
 Van Dyke, E. C., 6.
 Van Es, L., 42.
 Vaniman, V., 16.
 Van Kirk, M. S., 56.
 Van Lone, E. E., 72.
 Van Meter, R. A., 31.
 Van Norman, H. E., 5.
 Van Rensselaer, M., 47.
 Vansell, G. H., 6.
 Van Slyke, L. L., 48.
 Vasold, N., 16.
 Vass, A. F., 73.
 Vassanoja, H., 56.
 Vaughan, H. W., 34.
 Vaughan, P. M., 68.
 Vaughan, R. E., 72.
 Vaughn, E. C., 26.
 Vawter, L. R., 42.
 Veatch, J. O., 33.
 Vedder, M., 41.
 Veihmeyer, F. J., 6.
 Veitch, I., 29.
 Vernon, J. J., 67.
 Vernon, W. M., 20.
 Verret, J. A., 14.
 Vestal, C. M., 18.
 Vestal, E. F., 72.
 Vestal, F. E., 37.
 Vial, E. E., 46.
 Vial, J. M., 57.
 Vickers, G. S., 52.
 Vickery, H. B., 10.
 Victory, W. O., jr., 64.
 Viquin, R. M., 21.
 Vincent, C. C., 15.
 Vincent, C. L., 69.
 Vincent, G. W., 55.
 Vinson, A. E., 3.
 Vivian, A., III, 52.
 Voge, A. C., 17.
 Voges, C. R., 64.
 Volz, E. C., 22.
 von Ende, C. L., 14.
 von Tungeln, G. H., 20.
 Voorhies, E. C., 5.
 Vorhies, C. T., 3.
 Votey, J. W., III, 66.
 Wachter, H. M., 54.
 Waddell, R. L., 38.
 Wade, C. L., 67.
 Wade, I. E., 55.
 Wade, L. W., 19.
 Wade, O., 38.
 Wadleigh, C. B., 43.
 Wadsworth, H. A., 6.
 Waggner, S. M., 2.
 Wagner, F. A., 25.
 Wagner, F. E., 44.
 Wait, B. C., 56.
 Wait, C. E., 63.
 Waite, R. B., 20.
 Waite, R. H., 29.
 Waite, W. C., 35.
 Wakeland, C., 15.
 Wakeman, A. J., 10.
 Waksman, S. A., 43.
 Walden, B. H., 10.
 Walden, W. N., 44.
 Waldron, C. B., III, 50.
 Waldron, L. R., 51.
 Wales, R. L., 59.
 Walker, A. L., 45.
 Walker, B. M., 36.
 Walker, G. G., 53.
 Walker, G. P., 18.

- Walker, H. B., 24.
Walker, L. B., 41.
Walker, L. S., 31.
Walker, L. V., 67.
Walker, R., 27.
Walker, W. H., 64.
Walkey, F. L., 19.
Wallace, A. M., 31.
Wallace, B. A., 52.
Wallace, H. F., 37.
Wallace, H. L., 21.
Wallace, M. E., 50.
Wallace, Q. W., 20.
Wallace, R. C. E., 18.
Waller, A. E., 52.
Waller, A. G., 44.
Waller, C. H., 65.
Waller, J. A., jr., 67.
Waller, K. A., 73.
Waller, O. L., 69.
Walls, E. E., 21.
Walpole, B. A., 32.
Walrath, F. J., 59.
Walsh, F. E., 23.
Walsh, W. F., 49.
Walster, H. L., 50.
Walter, E. J., 57.
Walter, L. E., 73.
Walton, L., 28.
Walton, R. C., 58.
Walton, T. O., III, 63.
Wanlass, W. L., 66.
Wanser, H. M., 69.
Ward, A. L., 64.
Ward, F. C., 12.
Ward, L. S., 8.
Ward, W. B., 22.
Ward, W. G., 24.
Wardall, R. A., 17.
Wardell, E. L., 17.
Wardin, E. G., 49.
Ware, A. S., 65.
Ware, J. O., 4.
Ware, L. M., 1.
Waring, J. H., 58.
Wark, A. C., 44.
Warner, A. J., 47.
Warner, D. E., jr., 9.
Warner, H. W., 21.
Warner, Mrs. L. A., 63.
Warnock, L., 63.
Warren, D. C., 24.
Warren, G. F., 46.
Warren, G. R., 64.
Warren, J. J., 20.
Wartman, C. J., 68.
Washburn, F. L., 35.
Washington, Mrs. B. T., 2.
Washington, J. I., 61.
Washington, K. D., 8.
Washington, W. H., 60.
Wasson, G. E., 62.
Waterhouse, W. G., 6.
Waterman, J. S., 4.
Waters, M., 53.
Watkins, A. M., 47.
Watkins, D. W., 60.
Watkins, G. B., 24.
Watkins, L. J., 2.
Watson, C. W., 15.
Watson, J. R., 11.
Watson, M. E., 29.
Watson, P. P., 27.
Watson, T. G., 52.
Watts, R. J., 31.
Watts, R. L., 57.
Waugh, F. A., 31.
Waugh, G. L., 42.
Wautenpaugh, H. N., 57.
Weakley, C. E., jr., 70.
Weaver, D. S., 50.
Weaver, E., 19.
Weaver, F. P., 58.
Weaver, G. S., 62.
Weaver, J. E., 41.
Weaver, L. A., 38.
Weaver, L. E., 48.
Weaver, V. H., 17.
Weaver, W. E., 54.
Webb, E. G., 33.
Webb, W. L., 4.
Webber, H. J., 5.
Weber, A. D., 24.
Weber, G. F., 11.
Webster, G., 3.
Webster, N., 14.
Webster, R. L., 51.
Weems, C., 13.
Wegner, E. E., 69.
Wehr, E. E., 41.
Wehrle, L. P., 47.
Weidemann, A. G., 33.
Weimar, A. C., 32.
Weinard, F. F., 17.
Weir, W. W., 5.
Weiss, C. E., 73.
Welch, D. S., 48.
Welch, E. G., 26.
Welch, H., 40.
Weld, E. S., 56.
Weldin, J. C., 20.
Weldon, M., 17.
Weller, M., 35.
Welles, W. S., 31.
Wellhouse, W. H., 23.
Wellington, R., 49.
Wells, B. W., 49.
Wells, C. F., 62.
Wells, E. B., 23.
Wells, H. M., 34.
Wells, J. G., 32.
Wells, Mrs. K. M., 62.
Welsh, Mrs. C. P., 30.
Welsh, L., 39.
Welsh, M. F., 29.
Welton, F. A., 53.
Wenger, M. S., 17.
Weniger, W., 51.
Wentling, J. P., 35.
Wentworth, S. W., 43.
Wentz, J. B., 21.
Werkman, C. H., 20.
Werner, H. O., 42.
Wertz, V. R., 62.
Wescott, C., 48.
Wess, Mrs. J. P., 55.
Wessels, P. H., 48.
West, F. L., 66.
West, L. S., 47.
West, R. B., 65.
Westbrook, E. C., 12.
Westgate, J. M., 14.
Westgate, M. E., 58.
Westley, R. O., 73.
Weston, J. W., 33.
Westover, K. C., 70.
Wetherbee, D. H., 47.
Whaley, G. E., 60.
Whelan, A. D., 51.
Wheeler, E. W., 58.
Wheeler, J. T., 12.
Wheeler, R. H., 47.
Wheeler, W. P., 48.
Wheeting, L. C., 33.
Whelan, D. B., 41.
Whetzel, H. H., 48.
Whipple, B. K., 39.
Whipple, G. L., 56.
Whitaker, R., 46.
Whitcomb, D. D., 60.
Whitcomb, W. O., 40.
White, A., 30.
White, B., 30.
White, C. H., 29.
White, D. S., 52.
White, E., 69.
White, E. A., 47.
White, E. C., 45.
White, G. C., 9.
White, H. B., 35.
White, H. C., 12.
White, H. O., 3.
White, J. L., 27.
White, J. W., 57.
White, M. L., 68.
White, P. S., 53.
White, R. C., 64.
White, R. P., 24.
White, S. H., 17.
White, T. H., 30.
White, Mrs. W. P., 13.
White, W. R., 58.
White, W. T., 3.
Whiteford, G. H., 8.
Whitehead, L. P., 71.
Whitehouse, J. W., 26.
Whitehouse, W. E., 30.
Whitenton, R. O., 55.
Whitfield, J. E., 2.
Whiting, A. L., 71.
Whiting, R. A., 19.
Whitlock, M. C., 17.
Whitney, E. M., 9.
Whitney, J. F., 31.
Whitson, A. R., 72.

- Whittemore, H. L., 43.
 Wiancko, A. T., 17.
 Wickliff, E. L., 53.
 Wiedorn, W. S., 25.
 Wiegand, E. H., 57.
 Wiegand, K. M., 46.
 Wiggans, C. B., 65.
 Wiggans, C. C., 42.
 Wiggans, R. G., 46.
 Wiggin, G. H., 36.
 Wiggin, W. W., 29.
 Wight, H. M., 57.
 Wilbanks, W. C., 4.
 Wilbur, J. W., 18.
 Wilbur, O. M., 28.
 Wilcox, A. N., 36.
 Wilcox, L. P., 57.
 Wilde, E. I., 58.
 Wilder, C. N., 12.
 Wilder, H., 32.
 Wilder, S. Z., 62.
 Wildon, C. E., 60.
 Wiley, C. G., 13.
 Wiley, J. R., 18.
 Wiley, R. C., 29.
 Wilford, E. J., 26.
 Wilkes, C., 56.
 Wilkins, A., 41.
 Wilkins, F. S., 21.
 Wilkins, H. L., 45.
 Wilkinson, A. E., 9.
 Wilkinson, J. A., 20.
 Wilkinson, R. S., 61.
 Willaman, J. J., 34.
 Willard, C. J., 52.
 Willard, H. S., 73.
 Willard, J. D., 30.
 Willard, J. T., 24.
 Willard, R. E., 51.
 Willard, R. K., 51.
 Willey, C. R., 67.
 Williams, Mrs. A. B., 39.
 Williams, B. O., 60.
 Williams, C. B., 49.
 Williams, C. F., 50.
 Williams, C. G., 53.
 Williams, C. L., 49.
 Williams, C. V., 24.
 Williams, D. W., 64.
 Williams, E. A., 13.
 Williams, F. X., 14.
 Williams, G., 65.
 Williams, G. A., 18.
 Williams, G. P., 49.
 Williams, H. L., 27.
 Williams, J. C., 56.
 Williams, L. C., 25.
 Williams, L. F., 49.
 Williams, M., 54.
 Williams, Mrs. M., 13.
 Williams, P. S., 58.
 Williams, V. M., 49.
 Williams, W., 65.
 Williamson, Mrs. C. M., 50.
 Williamson, D. D., 43.
 Williamson, H. H., 64.
 Williamson, J. T. (Ala.), 1.
 Williamson, J. T. (S. C.), 61.
 Willis, J. W., 37.
 Willis, L. G., 49.
 Willis, M. A. (Del.), 10.
 Willis, M. A. (Miss.), 37.
 Willis, R. L., 44.
 Williston, D. A., 2.
 Willmarth, A. B., 66.
 Willoughby, C. H., 11.
 Willoughby, L. E., 23.
 Willson, C. A., 62.
 Willson, E. A., 51.
 Willson, L. H., 23.
 Willson, R. B., 47.
 Wilner, S., 51.
 Wilson, A. L., 66.
 Wilson, B. D., 46.
 Wilson, C. E., 53.
 Wilson, C. L., 46.
 Wilson, C. P., 45.
 Wilson, C. V., 70.
 Wilson, E., 27.
 Wilson, E. D., 28.
 Wilson, Mrs. E. L., 27.
 Wilson, F. W., 42.
 Wilson, G. E., 60.
 Wilson, H. E., 31.
 Wilson, H. F., 71.
 Wilson, H. T., 64.
 Wilson, I. D., 67.
 Wilson, J. F., 5.
 Wilson, J. K., 46.
 Wilson, J. T., 54.
 Wilson, J. W., 61.
 Wilson, L. V., 34.
 Wilson, M. L. (Mont.), 40.
 Wilson, M. L. (Tenn.), 63.
 Wilson, M. M., 69.
 Wilson, R. C., 12.
 Wilson, R. S., 36.
 Wilson, S. M., 58.
 Wilson, V. O., 54.
 Wilson, W. M., 48.
 Wilster, G., 65.
 Wimer, D. C., 16.
 Winant, H. B., 30.
 Winchell, J. A., 66.
 Winchester, G., 44.
 Wing, E. M., 8.
 Wing, H. H., 46.
 Wingard, S. A., 67.
 Wingate, W. G., 12.
 Wingfield, J. C., 25.
 Winkler, A. J., 74.
 Winkler, C. H., 61.
 Winslow, C. H., 66.
 Winsor, L. M., 66.
 Winter, A. R., 53.
 Winter, F. L., 16.
 Winter, O. B., 32.
 Winterer, E. V., 5.
 Winters, E. S., 2.
 Winters, R. Y., 49.
 Winton, B., 38.
 Wise, W., 32.
 Wiseman, C. R., 62.
 Withers, W. A., 49.
 Withycombe, R., 57.
 Witte, W. L., 38.
 Witter, D. P., 47.
 Wodsedalek, J. E., 15.
 Wojta, J. F., 72.
 Wolcott, G. N., 59.
 Wolf, F. A., 49.
 Wolfe, T. K., 67.
 Wolkoft, M. I., 16.
 Wood, C. J., 3.
 Wood, D. B., 72.
 Wood, I. D., 41.
 Wood, J. H., 12.
 Wood, L., 56.
 Wood, Mrs. M., 72.
 Wood, S. R., 55.
 Wood, W. H., 64.
 Woodard, C. S., 4.
 Woodard, O., 13.
 Woodbridge, H., 28.
 Woodcock, E. F., 32.
 Woodley, W. H., 4.
 Woodroof, J. G., 13.
 Woodrow, J. W., 23.
 Woods, A. F., III, 29.
 Woods, K. E., 10.
 Woods, M., 2.
 Woodward, C. R., 44.
 Woodward, K. W., 43.
 Woodworth, C. W., 6.
 Woodworth, H. C., 43.
 Woolley, J. C., 38.
 Woolman, H. M., 56.
 Woolsey, C., 4.
 Woolworth, C. M., 16.
 Wooster, R. S., 12.
 Worcester, M. A., 25.
 Work, P., 48.
 Working, E. B., 23.
 Working, H., 35.
 Works, G. A., III, 46.
 Worsham, C. G., 62.
 Worthen, E. L., 46.
 Worthington, A. D., 23.
 Worthley, H. N., 31.
 Wray, J. D., 50.
 Wrenshall, R., 13.
 Wright, A. H. (N. Y.), 48.
 Wright, A. H. (Wis.), 71.
 Wright, B., 58.
 Wright, C. C., 69.
 Wright, E. M., 68.
 Wright, F. B., 47.
 Wright, H. W., 20.
 Wright, J. B., 38.
 Wright, R. G., 43.
 Wright, T. R. H., 61.
 Wright, W. H., 71.

- Wright, W. J., 47.
 Wuichet, J. W., 52.
 Wylie, C. E., 62.
 Wynne, J. P., 37.

 Yancey, H. L., 10.
 Yapp, W. W., 16.
 Yates, W. W., 56.
 Yaxis, T. G., 30.
 Yeager, A. F., 51.
 Young, A. L., 17.
 Young, B. P., 48.
 Young, E. C., 19.
 Young, H. C., 53.
 Young, H. J., 41.

 Young, H. P., 66.
 Young, I. W., 55.
 Young, J. B., 63.
 Young, N. B., 39.
 Young, P. R., 47.
 Young, V. H., 4.
 Young, W. H., 16.
 Young, W. J., 53.
 Youngblood, B., III, 63.
 Youngman, W. H., 21.
 Yount, H. W., 31.

 Zahnley, J. W., 23.
 Zappe, M. P., 10.
 Zavoral, H. G., 34.

 Zeasman, O. R., 71, 72.
 Zeeuw, R. de, 32.
 Zelif, C. C., 1.
 Zeller, S. M., 56.
 Ziegler, P. T., 57.
 Zimmerley, H. H., 68.
 Zimmerman, P. W., 29.
 Zimmerman, R. S., 51.
 Zink, W. L., 6.
 Zook, L. L., 42.
 Zudreele, G., 15.
 Zundel, G. L., 69.

 ADDITIONAL COPIES

OF THIS PUBLICATION MAY BE PROCURED FROM
 THE SUPERINTENDENT OF DOCUMENTS
 GOVERNMENT PRINTING OFFICE
 WASHINGTON, D. C.

AT

10 CENTS PER COPY





UNITED STATES DEPARTMENT OF AGRICULTURE

MISCELLANEOUS CIRCULAR No. 18

WASHINGTON, D. C.

May, 1924

INSTRUCTIONS FOR BANDING BIRDS

BY

FREDERICK C. LINCOLN

Assistant Biologist, Division of Biological Investigations

Bureau of Biological Survey



WASHINGTON
GOVERNMENT PRINTING OFFICE

1924

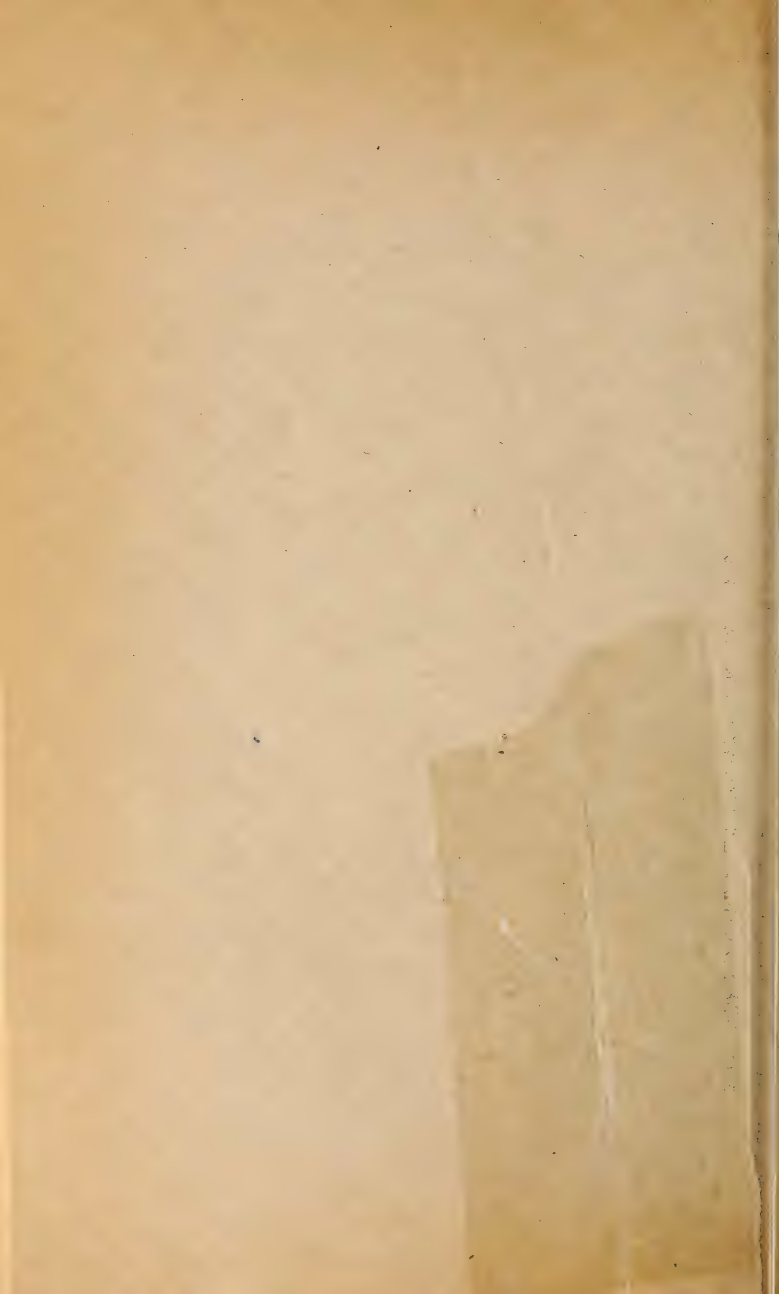

UNITED STATES DEPARTMENT OF AGRICULTURE

MISCELLANEOUS CIRCULAR NO. 18

WASHINGTON, D. C.

May, 1924

INSTRUCTIONS FOR BANDING BIRDS¹

FREDERICK C. LINCOLN

Assistant Biologist, Division of Biological Investigations
Bureau of Biological Survey

CONTENTS.

	Page.		Page.
Introduction.....	1	Bait for land birds.....	14
Trapping birds for banding.....	3	Operation of traps.....	15
"Government" sparrow trap.....	3	Handling captured birds.....	15
House trap.....	8	Attaching bands.....	19
Drop trap.....	9	Band holders.....	21
Canary-cage trap.....	11	Releasing birds.....	22
Nest-box trap.....	12	Reports.....	22
Gathering cage.....	13	Literature.....	26
Other methods of trapping.....	13	Problems that can be solved.....	27

INTRODUCTION.

Bird banding in America dates from the time of Audubon, who, about 1803, placed silver threads around the legs of a brood of phoebes and was rewarded the following season by having two of his marked birds return to nest in the same vicinity. In Europe, the "ringing" of birds was attempted as early as 1710, but it was not until 1899 that systematic work was undertaken. Between that year and 1914, about twenty different organizations took up the work, one of the results of their activities being an accumulation of valuable information on the habits and migratory movements of birds (Lincoln, 1921a).²

The earlier investigators marked their birds in a variety of ways, such as dyeing or staining the flight or tail feathers, attaching memoranda written on parchment, or mutilating feathers, feet, or bill. Obviously, such expedients would not be satisfactory for any general investigation. The most suitable device is the numbered aluminum band, or ring, attached to the tarsus, or bare portion, of one leg of the bird.

In the United States, active experimental work was begun in 1901, and several instances of bird banding were either planned or attempted during the next few years. One of these, by the New Haven (Conn.) Bird Club, was reported at the annual meeting of the American

¹ This circular is a revision of, and supersedes, Department Circular No. 170, *Instructions for Bird Banding*.

² Literature citations in parenthesis refer to the bibliography on page 26.

Ornithologists' Union in 1909, with the result that the American Bird Banding Association was organized in New York City on December 8 of that year. This organization continued to advance the work, during the last few years of its existence under the auspices of the Linnaean Society of New York, until it outgrew the resources available. The work done under the direction of this association (Cleaves, 1913), together with the development of the method of systematic trapping (Baldwin, 1919), demonstrated the great possibilities of extensive operations. And, as it was realized that the information resulting from banding migratory birds, particularly waterfowl, would be of much value in the administration of the migratory-bird treaty act, the work was taken over by the Biological Survey in January, 1920.



B1534M

FIG. 1.—Typical trapping station, showing well-placed trap and gathering cage inside of guard fence. (Photograph by S. Prentiss Baldwin.)

This method of research is receiving attention along these two principal lines: First, the banding of fledglings, as formerly practiced; and second, the systematic trapping and banding of adults.

The latter is being given special emphasis, for, since it is the returns from banded birds that furnish the information desired, it is obvious that the method that will yield the largest number of returns should be intensively developed. Nothing has been found more satisfactory for the accomplishment of this object than systematized trapping. As the banding of fledglings, however, has the advantage of affording valuable information on the ages of birds, the Biological Survey desires to encourage this activity also, particularly as applied to those species which can be trapped readily as adults, or which, for any reason, are likely to be reported as "dead returns."

With the establishment of a well-connected chain of trapping stations (fig. 1) throughout the United States and Canada, regular

"return" records may be obtained by retrapping banded birds at the original and other stations. Data already made note of indicate the exact lines of migration of individual birds, the speed of travel, and innumerable other items of interest, all of which have a direct bearing on the study of life histories. A lively interest attaches to the work, as each operator of a station is continually anticipating that birds banded at other stations may at any time come to his own traps.

TRAPPING BIRDS FOR BANDING.

Under the migratory-bird treaty act, a Federal permit is required before one can do bird banding. Application for such permit should

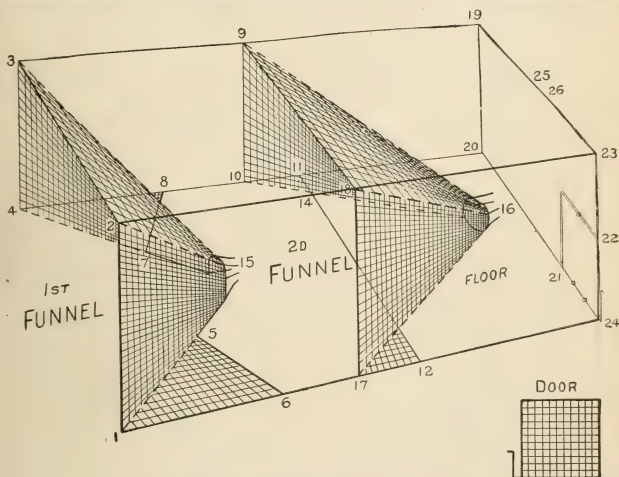

FIG. 2.—Details of construction of Government sparrow trap, similar to that in operation in Figure 1. Relative position of funnels and door is shown. The numbers at the angles correspond to those in Figures 3, 4, and 5.

be addressed to the Bureau of Biological Survey, United States Department of Agriculture, Washington, D. C.

After having received the necessary permit and a supply of bands, the bird-banding cooperator should have adequate information as to the most suitable traps. For trapping land birds, the Government sparrow trap has been generally satisfactory. Other traps, there being several kinds on the market, will also give satisfaction. But there is a distinct advantage in having a standard type, which birds may come to recognize as a source of food, and for this reason at least one standard trap is recommended for each station.

"GOVERNMENT" SPARROW TRAP.

The following specifications will enable anyone moderately skilful in the use of tools (tin snips, pliers, file, and hammer) to make

the "Government"³ sparrow trap in a few hours, and at a small cost, or the job may be given to a tinner or sheet-metal worker. Galvanized hardware cloth of not to exceed $\frac{1}{2}$ -inch mesh is used.

The essential parts of this trap (fig. 2) are: (1) A half funnel leading into (2) an antechamber that ends in (3) a complete funnel with outlet slightly elevated, opening into (4) a second chamber, and (5) a number of blunt wires that are attached to the outlets of the funnels and project into the respective chambers. These blunt wires should be about 3 inches long on the first funnel and about 2 inches long on the second.

The plans outlined in these pages are for a trap 36 inches long, 18 inches wide, and 12 inches high, a good size for most work, as it is not cumbersome or heavy. A larger trap might be used to advantage at stations where conditions would not necessitate much moving.

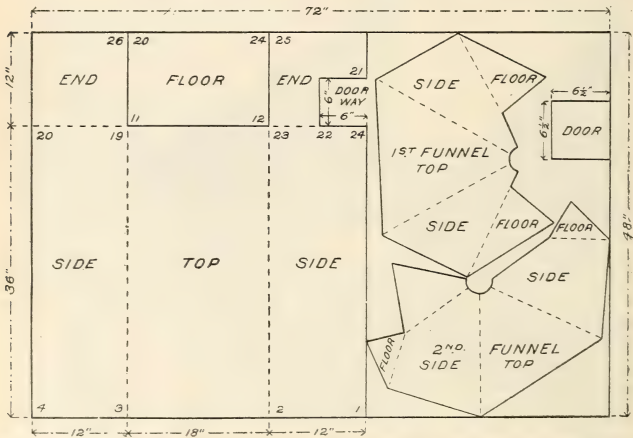

FIG. 3.—Diagram for cutting galvanized hardware cloth 72 by 48 inches for trap measuring 36 by 18 by 12 inches, outlined in Figure 2.

To construct this trap, two rectangular wire frames 36 by 12 inches are first bent into shape from No. 8 or No. 10 wire of moderate stiffness. This kind of wire is also used for the framework of the door in the second chamber, and to reinforce the netting around the doorway and the mouths of the funnels. It is well, though not necessary, to solder the joints to make the frame rigid.

To start construction, one of these wire frames is placed lengthwise (see fig. 3) on one corner of a strip of the hardware cloth measuring 42 by 48 inches, and is securely laced thereto with copper wire of about No. 20 size, such as is commonly sold on wooden spools. This makes one side. Before proceeding further a piece of netting, 18 inches by 12 inches, is snipped out of the middle of that part of the netting projecting beyond the frame. This piece is

³ Specifications for the so-called "Government" sparrow trap were first published in Farmers' Bulletin 493, issued April 20, 1912.

saved for the floor of the second chamber. The netting is then bent twice to form the top (18 inches by 36 inches) and the second side. To this side the other rectangular wire frame is laced in the same way as the first.

A simple way of making the bends in the netting straight is to place the netting on the floor, lay a board across it with one edge along the line where the bend is desired, stand on the board, and bend the netting up, tapping it lightly with a hammer against the edge of the board. This will give a straight, even, right-angle bend.

The bends should be made so as to have the heavy framework on the inside. At this stage, the top and sides are completed, the latter with projections measuring 12 by 12 inches beyond the framework

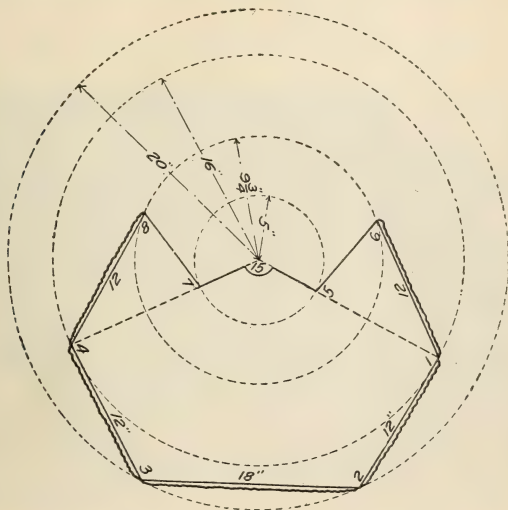

FIG. 4.—Pattern for first funnel of trap shown in Figure 2.

at one end. These should be bent in to form the back, and laced together and to the top, with the copper wire. They will now lap over each other about 6 inches.

The opening for the door (6 inches square) is then snipped out of one of the lower corners of the back, and the edges are reinforced with a piece of the heavy wire. If the netting is cut so as to leave the wires projecting from the last row of meshes, these may be so bent around the reinforcing wire as to give both smoothness and strength.

A narrow strip (about 3 or 4 inches wide) of fine screen or netting should now be fastened along the lower portion of the sides and back. Ordinary window-screen wire will answer, although the galvanized netting of about $\frac{1}{8}$ -inch mesh is preferable. This will prevent small

birds from injuring themselves by trying to force their way through the larger meshes.

The funnels are made next. Paper patterns are made first, as shown in Figures 4 and 5, by drawing the concentric circles and then laying off the straight lines, beginning with the longest. To draw large circles, lay the paper on the floor, drive a nail for a center, and attach a string to it; with this string and a pencil, circles of the desired radii may be easily drawn.

The outlets from the funnels should be large enough to allow birds of the size of jays, thrashers, and robins to pass through. Several blunt wires (about the size of baling wire) are attached to the outlets so that they will project into the first and second chambers

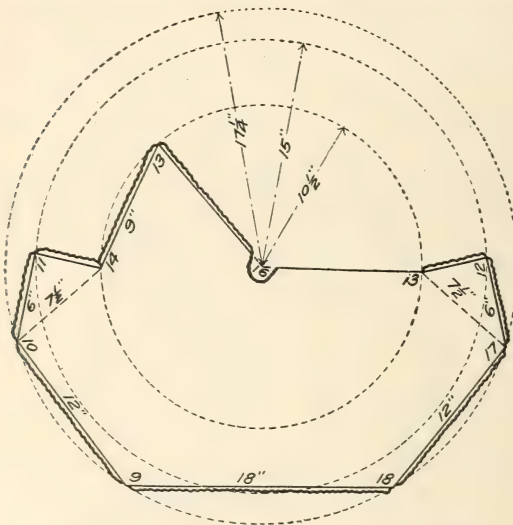

FIG. 5.—Pattern for second funnel of trap shown in Figure 2.

3 inches and 2 inches, respectively. These may be fastened to the funnels by weaving them into the netting. The inner ends should then be soldered or merely bent back and pinched tight with the pliers. By adjusting these wires, birds of different sizes may be admitted or excluded as desired. Sharpening the wires is unnecessary and would be liable to injure the birds. It is of great importance that the birds banded be released in as sound and healthy a condition as they were trapped.

Figure 3 shows how all the parts of a trap may be cut from a piece of netting 4 feet wide and 6 feet long. The wavy outlines in the patterns (figs. 4 and 5) indicate that the cut is to be half an inch outside of the straight lines, to allow extra wire for fastening the funnels to the trap. The full lines in all figures pertain-

ing to this trap indicate where the netting is to be cut and the dotted lines where it is to be bent. The numbers at the angles in Figures 3, 4, and 5 correspond to those in Figure 2, which shows in outline the relation of the different parts as they appear when assembled.

The funnels and the floor for the second chamber are securely laced in place with copper wire, the outlet from the first funnel being on the ground level, while that of the second is elevated 3 or 4 inches. There is no floor in the first chamber, except in that part covered by the extensions from the funnel, which are intended primarily to give strength. Bait shows to better advantage on the bare ground, and it is frequently necessary to remove a bird from this chamber, a matter of considerable difficulty if netting covers the entire bottom.

The door is readily made, by attaching a piece of netting to a wire frame. It should be hinged at the bottom so as to drop against the

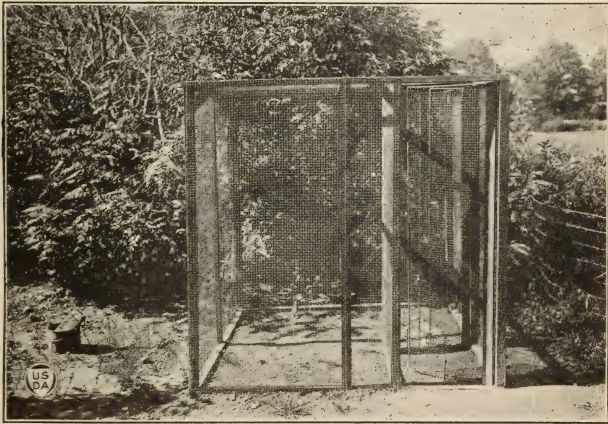

FIG. 6.—House trap. An excellent trap for the permanent station. (Photograph by S. Prentiss Baldwin.)

floor of the trap, and the wire forming the bottom, or axle, should project an inch or two beyond the side. This is then given two right-angle bends to form a crank by means of which the door is lowered when a bird is to be transferred to the gathering cage. The door should be about $6\frac{1}{2}$ inches square.

See that all projecting wires in the netting are bent down smoothly. Greater strength may be gained by bending these around the framework at the sides and weaving them into the connecting pieces.

This trap has the advantage of being always set, of being suitable for all small birds up to and including those of the size of robins and jays, of having no loose parts, and thus of requiring no tools to keep it in order. It is not heavy, and, when painted a leaf green, will be inconspicuous and not frighten the birds.

HOUSE TRAP.

Where premises are large enough to justify establishing a permanent station, a house trap (fig. 6) will give excellent service.

Select a location adjacent to trees or shrubbery, and set up a framework about 5 feet square and 6 feet high, of 2-inch uprights, such as may be made by ripping 2 by 4 inch timbers. Three extra uprights will be needed to make a vestibule and casings for the doors

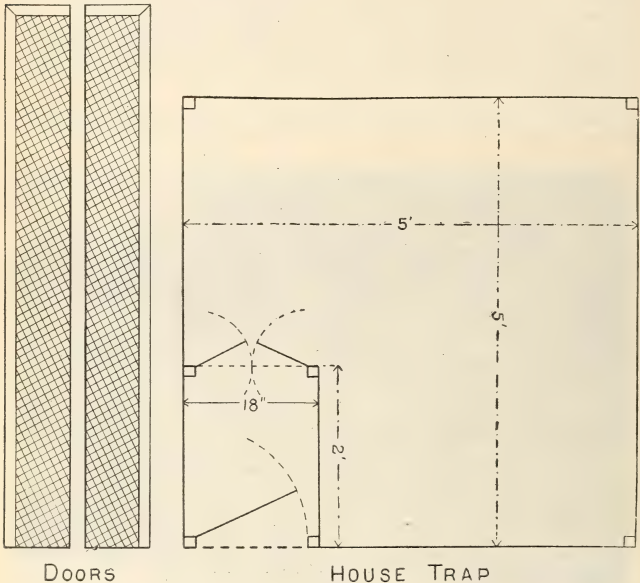

FIG. 7.—Ground plan of house trap shown in Figure 6. The drawing illustrates the vestibule and the correct position of doors when trap is set.

(fig. 7). Cover this framework with woven-wire netting of mesh not larger than $\frac{3}{4}$ -inch. Stretch a piece of the netting between two extra uprights that are placed 2 feet apart and 18 inches from one side, thus making a vestibule or partial partition in the trap.

A door frame is made of light, narrow pieces of lumber, covered with the wire netting, and hinged so that it will open *into* the vestibule. The inner opening is provided with two doors, of which only the tops and hinged sides are of wood. The inner edges and bottoms of the doors are formed by a heavy wire (or a $\frac{1}{4}$ -inch soft-iron rod), which serves merely to stiffen the netting. This provides a minimum of visual obstruction to any bird that may be entering. Do not have a threshold under the doors, as most birds will not cross one, even though it is made level with the ground.

Leaving these doors partly open, and the outer door ajar a few inches, makes an effective funnel trap. Figure 7 illustrates the ground plan and the correct position of the doors when the trap is set. A trap of this type, operated by the writer at the National Zoological Park in 1920, was very satisfactory, catching thrushes, orioles, warblers, and other species that are reluctant to enter smaller traps.

DROP TRAP.

The drop trap, a device which is merely an adaptation of the old and well-known "sieve trap," is easily and cheaply made and, although not usually automatic in its operation, has already proved very useful at many stations. It is particularly serviceable in the

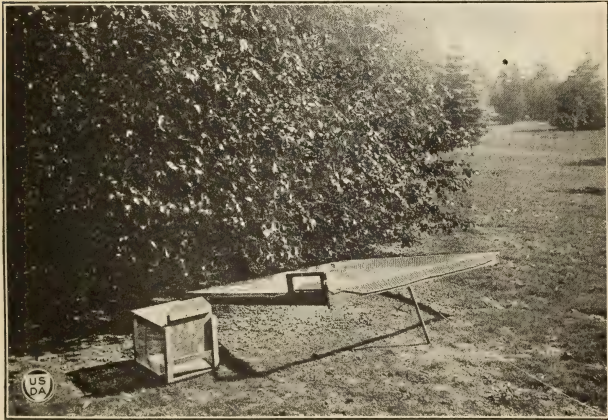

FIG. 8.—Drop trap made by covering a wooden frame with small-mesh twine netting. When made in this way, it is advisable to have each corner supported by a "leg" about 3 inches long. Canvas or duck is stretched between these legs, thus eliminating danger to any bird that might be struck as the trap falls. Gathering cage at the left. (Photograph by S. Prentiss Baldwin.)

summer, when, because of an abundance of natural food, many birds hesitate to venture into the compartments of "cage traps." (Fig. 8.)

The best form of drop trap is that of an inverted tray made of wire netting (fig. 9), one side supported 8 to 10 inches above the ground by a light stick to which the "pull string" is attached. The tray should be about 4 feet square and 4 to 6 inches deep. It is made with a single piece of $\frac{1}{2}$ -inch-mesh wire cloth. Two sides are first bent to right angles, in the manner previously described, and cuts made at the four corners for a distance equal to the depth wanted in the tray. The other two sides, being cut so that they also can be bent, are bent up, and the projecting portions of the first two are bent around them and wired fast to make the corners of the tray.

There should be a small door, similar to the one described for the sparrow trap, at one corner, through which the captured birds may be driven to the gathering cage.

Another trap of this same type, which has been used with signal success, principally by cooperators in the New England States, con-

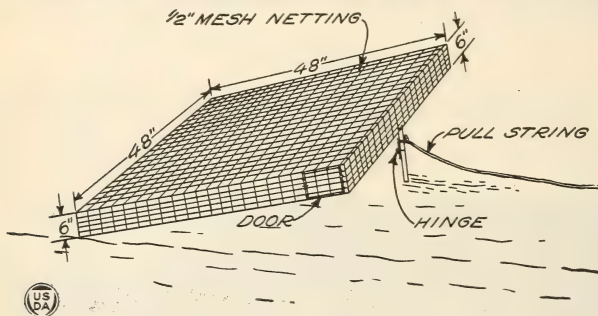

FIG. 9.—Details of drop trap. An effective and inexpensive type, excellent for the beginner. Illustration shows supporting stick cut and hinged in the middle to prevent the tray from swaying when the cord is pulled and also to insure more rapid action.

sists of a tray of greater depth (8 to 10 inches) in which the sides are hinged to the top with wire rings, so that the trap may be folded and easily carried from place to place. When operated, the tray

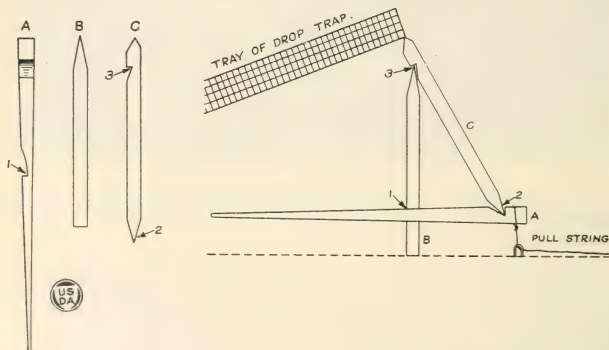

FIG. 10.—"Figure-4," an efficient device that may be used to make a drop trap automatic in action. The sticks are about three-eighths of an inch square.

stands on three sides, the fourth being supported in a horizontal position by a stick to which a "pull string" is attached.

In order to eliminate swaying when the string is pulled and to provide more rapid action, it is advisable to cut the supporting stick in two and fasten the pieces together with a small hinge. Have the hinge on the inside when the trap is set. A light pull on the string will drop the tray instantly.

This trap may be made automatic by using a "figure-4" instead of simply the one stick. The bait may be put on the tip of the horizontal trigger piece, or the trigger may be so constructed as to offer an inviting perch (fig. 10).

CANARY-CAGE TRAP.

The canary-cage trap is a simple contrivance which has been one of the surprises developed since the inauguration of the bird-band-

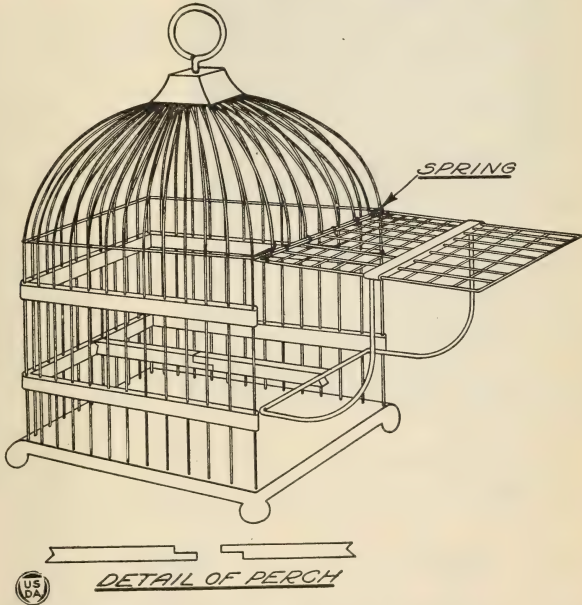
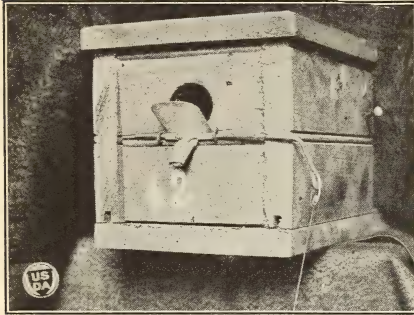

FIG. 11.—Canary-cage trap. Simple in construction and admirably suited for use at window-feeding shelves.

ing project. (Fig. 11.) The back is cut out of an ordinary brass-wire canary cage; and a door of equivalent size, made from hardware cloth, is substituted. The door is hinged at the top with wire rings and fitted with a light spring (a rubber band will do) to make it close quickly. A wire loop is attached to the middle of the door, the two ends being fastened on opposite sides of the door, in such a way that when the door is open—that is, in horizontal position—this loop will project downward and curve in to the entrance to the cage, where it is supported by, and at the same time supports, the "broken perch." This perch is provided with a "half-lap" joint in the middle, which may be adjusted so delicately that

the weight of the lightest bird will cause it to "break," thus releasing the wire loop and permitting the door to descend and close.

Traps of this type are well suited to use on window-feeding shelves, and they have also been successfully used on the ground, on roofs of porches, and in similar places.



B 1643M

FIG. 12.—Nest-box trap. A device used to capture adult birds while nesting in boxes or other cavities. Particularly valuable as an aid to life-history studies. (Photograph by S. Prentiss Baldwin.)

NEST-BOX TRAP.

For the purpose of making detailed studies of the nesting habits of many birds, the trap-door perch is most effective. (Fig. 12.) A small piece of sheet metal, such as tin or zinc, is so bent upon a piece of wire that it serves as a perch or platform. By means of two small staples that act as bearings, the device may be fastened immediately beneath the entrance hole in a nest box or tree

trunk, and caused to rise from a horizontal to a vertical position by pulling a string attached to the wire axle, which is extended and bent at right angles to form a crank. As shown in the illustration, the wire is also bent into a loop that serves as a bracket to keep the perch in

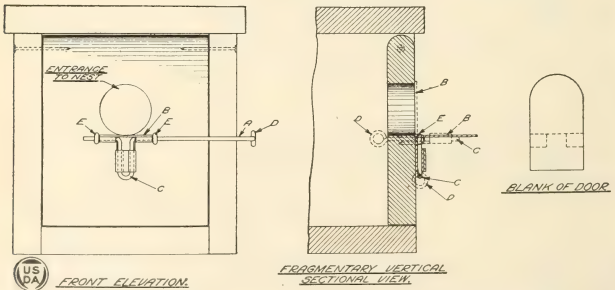

FIG. 13.—Details of construction of nest-box trap shown in Figure 12.

a horizontal position when open. A small block of wood will answer just as well as the sheet-metal perch.

When used on nest boxes, the front of the box should be built so that it may be opened in order to take out the captured bird. Figure 13 illustrates the details of construction. The edges of the top of the front are rounded off, so that the whole section may be pulled

out and up, pivoting on two nails driven in from the sides near the top.

In order to take out birds caught in nesting holes in trees, a long-handled net should be used, such as appears in Figure 14. This may be slipped over the hole, and the trap door allowed to drop. Usually, the bird will fly at once out into the net. Figure 12 shows one of the nest boxes equipped with this device, which has been successfully used by S. Prentiss Baldwin in his study of the habits of the house wren.

GATHERING CAGE.

Do not attempt to seize a bird in the trap chambers, unless absolutely necessary. Use a small gathering cage, and drive the birds into it gently, thereby eliminating much of the fluttering that is bound to occur in the larger spaces of the trap. Such a cage, 12 inches long and 6 inches square (the size of the doorway in the Government sparrow trap), is readily constructed from a piece of hardware cloth 1 foot wide and 2 feet long. A piece of netting is laced in to form the back, and the door is made to operate in the same manner as that of the trap. The door should drop inward in each case, and lie flat on the bottom when the cage is open. (See fig. 1.)



FIG. 14.—Short-handled landing net attached to extension pole, for use in capturing birds in nest boxes, bank-nesting birds, and others. The leafy branches in the lower right part of the picture were placed there as a blind to conceal the operator. Photograph taken at bank-swallow colony near Washington, D. C., by the author.

OTHER METHODS OF TRAPPING.

Various other methods of trapping birds for banding will suggest themselves to the operator. It must be remembered, however, that birds are likely to become more or less frightened when caught in any trap, and traps that will grasp or seize them must not be used except in special cases.

The capture of small birds at their nests by means of hair-nets (such as are worn by women, or those specially made for this purpose from horsehair) is permissible when the operator remains within sight

of the nest, ready to release the bird immediately. Generally, such methods should be used only when observation has revealed that one or both of the parent birds are wearing bands, of which it is desired to obtain the numbers without injury to the carriers. There is much less danger that the parents will desert the nest if such operations are delayed until the young are about half fledged. From present knowledge it is not safe to use horsehair loops or snares for this purpose.

Bird lime should not be used under any circumstances, as it is virtually impossible to release in good condition a bird that has been caught by its use.

For capturing swallows, kingfishers, and other birds that nest in banks, the net mentioned in connection with the nest-box trap (fig. 14) will be found useful.

Banding waterfowl and shorebirds is of great importance, and various traps for this purpose may be constructed easily by an ingenious operator. Such traps usually take the form of the funnel trap on a large scale; or, for diving birds, an open pen in about 2 feet of water, with a rising door operated from a blind located at a convenient distance. Such operations frequently involve considerable expense, and, of course, can be carried on only by operators properly situated with relation to the habitats of these birds. The Biological Survey will furnish details of trap construction, and otherwise assist operators contemplating such activities.

BAIT FOR LAND BIRDS.

Crumbled bread has been found to be the best all-round bait, but it is well to use finely cracked grain with it, as wheat or corn, with hemp, millet, or other small seeds, particularly since a large percentage of captures are likely to be seed-eating birds. Whole corn or wheat will not answer. Weed seeds, which may be collected in abundance in the fall, make excellent bait.

Robins, catbirds, and many other birds are notoriously fond of small fruits. Small branches bearing cherries, wild haws, mulberries, or other fruits are effective baits during the summer. Insects should also be used at this season. Meal worms may be readily raised, and a constant supply kept available,⁴ while the larvae of borers and other insects may be obtained under the bark of old logs.

Vary the bait with the season, and remember that even seed-eating birds consume large quantities of insects in summer. Cereal and fatty foods are heating, and, while desirable in winter, are not readily taken during hot weather. Weed seeds, previously mentioned, may occasionally be obtained in large quantities from elevators where wheat, oats, and other grains are cleaned. Corn bread, cooked macaroni, cooked and uncooked pie crust, nut kernels, suet, and many other baits will suggest themselves to the attentive operator.

A supply of water, either for drinking or bathing, will prove a potent attraction. With most traps, the water receptacle may be

⁴The Biological Survey will furnish full instructions for raising meal worms to those interested.

placed within the chamber and it will be as much appreciated in winter as in summer.

OPERATION OF TRAPS.

In setting the Government sparrow trap, or any other of the cage variety designed for land birds, a place should be selected on open ground close to trees or shrubbery. A trap should not be set actually in a wooded area, but sufficiently close to be easily accessible to the birds that it is desired to attract.

Protect the trap from cats, by erecting a guard fence. A piece of poultry wire 3 feet wide and 60 feet long will inclose an area approximately 20 feet in diameter and will protect birds visiting the trap. An effective guard fence is shown in Figure 1. During the winter months small traps may be operated to advantage on feeding shelves.

Scatter the bait thinly on the ground around the trap, more plentifully at the entrance and in the funnels, and abundantly inside the trap chambers. It is well to put crusts and larger pieces well inside the trap. In baiting the large house trap, the chamber should be liberally strewn with bread crumbs and seeds, and a trail of bait laid through the doors and vestibule. A little bait should then be scattered around the outer door as an appetizer.

Visit any trap frequently. Once every three or four hours will suffice during the migration periods, but visits of greater frequency are necessary during the nesting period, especially when the young are being fed at the nest. Be particularly careful to visit all traps just before dark to see that no birds are confined over night.

When a capture has been made with one of the small traps, the gathering cage is placed against the door of the trap and both doors are lowered. The birds are then driven into the cage, and the door is raised by means of the projecting bent axle. This is particularly convenient when several birds are trapped at once, but if the trap should contain both large and small birds, remove the larger ones first. Do not drive large and small birds together into the gathering cage, as the larger individuals are likely to injure the smaller.

For removing birds from the house trap, the short-handled net previously mentioned may be used. The nets used by fishermen as landing nets are excellent for this purpose, or a satisfactory one may be made by attaching a cheesecloth bag to a heavy wire frame. Force the birds quietly into a corner and slip the net over them without undue haste. Never attempt to capture a bird with the net as it flies across the trap. The chances of breaking a wing or otherwise injuring the bird are great, and this risk is entirely unnecessary.

HANDLING CAPTURED BIRDS.

In handling small birds, the utmost care must be exercised. It is of vital importance that they be so handled that they will be in perfect condition when liberated. Almost without exception, small birds are highly nervous, and a quick pressure by the operator following some spasmodic struggle of the bird may kill it, or so seriously injure it as to make killing necessary. Furthermore, it must

be remembered that, if the information to be gotten from the banding of birds is to be of value, the carriers must be strong and healthy and not handicapped in any way. Under no other conditions may their movements be considered as normal.

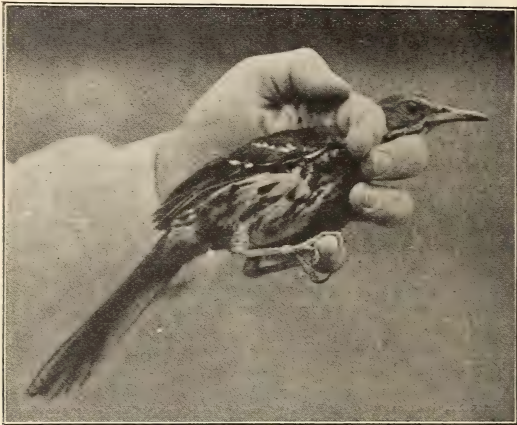

B1532M

FIG. 15.—Manner of holding bird when removing it from gathering cage. If the bird is already marked and it is necessary only to examine the band, this position need not be changed. See also Figures 16 and 17. (Photograph by S. Prentiss Baldwin.)



B1531M

FIG. 16.—Manner of holding small bird for banding. See also Figures 15 and 17. (Photograph by S. Prentiss Baldwin.)

To remove a bird from the gathering cage for banding, reach into the cage, blocking the opening around the arm with the other hand, and work the bird into a corner. It will almost surely be facing away from the operator. Grasp it in such manner as to pinion its neck between the thumb and index finger, and the wing tips, tail, and feet by the little finger closed against the palm. In this position, the bird may be held quietly without using undue force. Strangely enough, securing the bird's head or neck will almost invariably cause it to cease struggling.



FIG. 17.—Manner of holding small bird for banding. Suitable for persons with stocky hands. (Photograph by Wm. I. Lyon.)

If the bird is already banded, and only a simple examination is necessary, this position need not be changed, as the band may be readily turned with the free hand and the number read. Or, the bird may be allowed to perch on the little finger, the neck secured between two fingers, as before. Most birds will rest quietly in this position, which has the advantage of permitting an examination of the entire body. (See fig. 15.)

To place a bird in position for banding, grasp its head lightly but securely with the thumb and the index and second fingers of the other hand; release all other hold and by quickly reversing the position of the bird, draw it through the free hand with its back against

the palm, and close the little finger over the neck, and the other fingers around the body. This position is exactly the reverse of the original one, in that the bird's feet, wings, and tail are now held by the second finger, whereas in the other case this was accomplished by the little finger against the palm. The thumb and index fingers are now free to hold the tarsus while attaching the band. (See fig 16.)

This system of handling small birds has been found to be entirely satisfactory where the fingers of the operator are long and slender. But operators who have short, stocky hands will do well to learn the method indicated in Figure 17. In this method the bird is taken from the gathering cage in the same manner, but instead of pinioning the feet, the right foot is grasped between thumb and second



FIG. 18.—Manner of holding ducks for banding. Birds of this family are usually remarkably gentle when they realize that they are prisoners.

finger, the other fingers supporting the bird's weight. In this way, the bird's wings are held against the palm of the hand, the only part left free being the left foot, and with this foot the bird will usually grasp the little finger.

Ducks, and some other birds of similar size usually are remarkably gentle once they realize that they are helpless. Figure 18 shows a drake mallard, one of several hundred caught and banded by the writer; almost without exception, these were easily held by light pressure against the body, the leg being the only part actually held.

Great care must be exercised in working with herons, as these birds strike with snakelike rapidity, and the blow is likely to be toward the eyes, because of their brightness. Hold the heron's neck firmly, and, if possible, cover its entire body with a sack or old coat during the banding operation.

With hawks and owls, the beak is of minor importance, as it is rarely used as a weapon of offense or defense. Generally, these birds will throw themselves on their backs, talons drawn up, ready to strike. In this position, a stout stick may be slipped under the feet and gradually worked back, forcing the feet down against the tail. Once outstretched, they may be kept in position by holding the stick with one knee or foot. The bird's ability to grasp is almost nil when its legs are straightened out.

When working with such birds, it is advisable to wear gloves, for a scratch from bill or claw may result in blood poisoning.

ATTACHING BANDS.

Never band a bird the identity of which is at all doubtful. To do so might result in a false record that would occupy a permanent place in the files. It would then furnish misleading data that would seriously interfere with the scientific accuracy of the work, and might cause wrong conclusions to be drawn from the records.

Do not attempt to band birds recently hatched or just a few days old; wait until they are fully fledged and about ready to leave the nest. The legs of most fully fledged young birds are larger and more fleshy than those of the adults, so that allowance for growth need not be made.

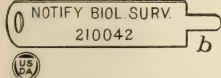

FIG. 20.—No. 6 lock bands: a, Closed; b, outer side, straightened out. Suitable for small owls, crows, teal ducks, large terns, small gulls, and small herons.

owls, crows, teal ducks, large terns, small gulls, and small herons; and a flat-strip band that is adjustable for all larger birds.

Split-ring bands.—Always select the smallest-sized band (fig. 19) that will close around the bare portion of the foot or leg immediately above the toes without binding or chafing. The band should move up and down freely and turn easily and smoothly, but should not fit loosely like a bracelet. With large birds, this last is not so important, but with small perching birds there is considerable danger that twigs or thorns may catch in a band that fits too loosely. Where necessary, lap the edges of the band, but see that the edges of the lap are smooth. Projecting edges may catch in nesting material. While the danger from open bands is great, there is also the danger of lapping the band so far as to cause it to bind or pinch. This might ultimately cause complete paralysis of the foot.

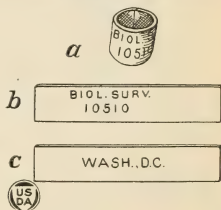

FIG. 19.—Split-ring band, enlarged: (a) Closed; (b) straightened out, outer side; (c) straightened out, inner side.

Water birds, however, are an exception to this rule.

The bands issued by the Biological Survey are of three types (see figs. 19, 20, and 21)—a split-ring band, sizes Nos. 1 to 5, inclusive, for all small birds, including those of the size of sparrow hawks, large rails, and large shorebirds; size No. 6, which is a lock band suitable for small

A pair of small, pointed pliers, such as those opticians use (see fig. 22, *C*), is practically indispensable for this work, and a little practice with this tool will give such skill in using it that the band can be placed accurately and rapidly. Any round, pointed instrument will answer to open the band to get it around the bird's leg: a metal pencil is satisfactory, but the best tool for this purpose is the stiletto, used to make eyelets in embroidery work. Figure 22, *B*, shows one of these tools set in a hardwood handle. They may be bought for 5 or 10 cents at stores handling embroidery supplies.

Caution.—If a bird, while in the hand, should take advantage of a momentary relaxation of the fingers and get loose, do not attempt to grasp it from the air, but rather allow it to escape quietly, and trust to recapturing it. The desire to seize an escaping bird is almost instinctive, and it requires thorough control to keep from it. But no matter how quick the lunge toward an escaping bird, it will generally net nothing more than a handful of feathers, usually the tail,

while the chances of breaking a wing or otherwise injuring the bird by grasping it are very great.

No. 6 lock bands, and flat-strip adjustable bands.—These two bands, being thicker and having special locking devices, require somewhat more skill to put them on. (Figs. 20 and 21.) Pliers are absolutely necessary, the best type

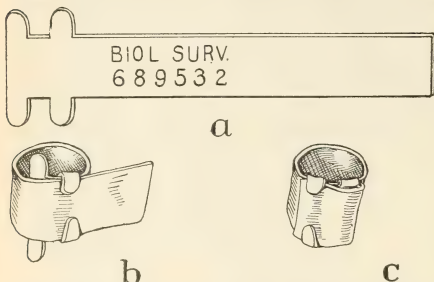

FIG. 21.—Flat-strip band, adjustable: (a) Outer side, straightened out; (b) band partly locked; (c) band fully locked and excess length snipped off.

being those shown in Figure 22, *A*, with jaws 2 inches long and flat tips about one-eighth of an inch across. Loom fixers' pliers ground down to this size are excellent. In addition, a pair of diagonal wire cutters, or a pair of stout-bladed scissors, will be necessary to trim off the excess length from the adjustable bands.

In closing band No. 6 care should be taken to see that the locking nib is all the way through the slot before it is bent back. Figure 20 shows one of these bands when out flat, and also when closed and properly locked.

The adjustable bands, which are received flat, may be roughly shaped around a finger and then opened to admit the bird's leg. The band is then pressed together and its diameter reduced to where it fits smoothly. The second pair of nibs from the lock end are then bent over, and pinched tight with the pliers. The strip is now bent back, the bend pinched together as close as possible, and locked with the first pair of locking nibs. Excess length is then trimmed off and the end of the band is pressed down smoothly with the pliers.

Caution.—See that the number is on the outside. Attaching these bands requires care and patience. The metal is so stiff the bird's leg may be broken if the operator is not careful. Put all pressure on the band, and not the leg, and there will be no trouble.

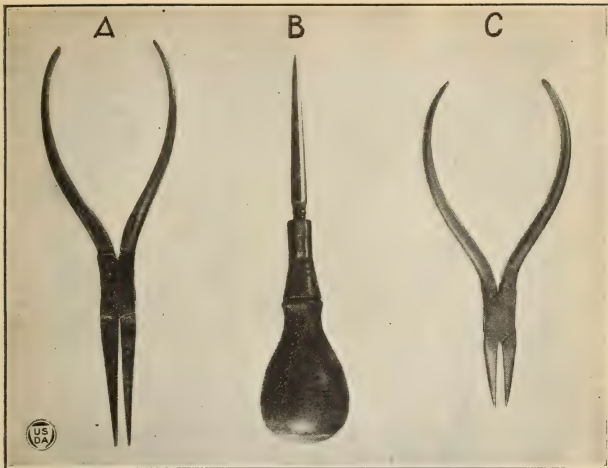

FIG. 22.—Tools used for attaching bands. *A*, Pair of pliers with 2-inch jaws about one-eighth of an inch across the tips; used to attach lock bands. *B*, "Stiletto" set in a hardwood handle and used to open small ring bands. *C*, The best type of pliers for closing the smaller bands; they have smooth pointed jaws and may be obtained from dealers in optician's supplies.

BAND HOLDERS.

It is an advantage to have the bands arranged on a holder in numerical order. Figure 23 shows a holder that has proved satisfactory for the ring bands, particularly the smaller sizes. It is simply a large, blunt-pointed safety pin, and is easily made from a piece of galvanized iron wire. A similar device, made to hold stitches when knitting, may be purchased from stores that handle such supplies. Or, the large safety pins commonly used on horse blankets may be used for this purpose.

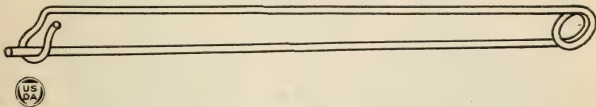

FIG. 23.—Holder on which ring bands are placed in reverse order. Made of galvanized iron wire and long enough to hold at least 25 of the smaller bands (about 6 inches).

The flat adjustable bands are best carried in racks, such as shown in Figure 24. The vertical inverted U-shaped holders are made of galvanized iron wire, one standing about a half inch higher than the other. The bands are held in place by an elastic band, the legs of the higher U passing between the locking nibs. The elastic holds them tightly together while the operator is going to and from the trapping ground, but it is removed when he is engaged in banding. By lifting one side of the top band it is easily taken from the rack.

RELEASING BIRDS.

The simplest way to release a banded bird is merely to open the hand and let the bird fly when it wants to. Do not throw it into air, or frighten it into flight, as this will only add to the difficulty of retrapping. Frequently, a bird will lie quietly after the hand is opened, not seeming to realize that it is free (see figs. 25 and 26), and it may even permit gentle stroking or the spreading of a wing. Such occurrences are interesting bits of life history information, and should be watched for and encouraged, and also reported in detail.

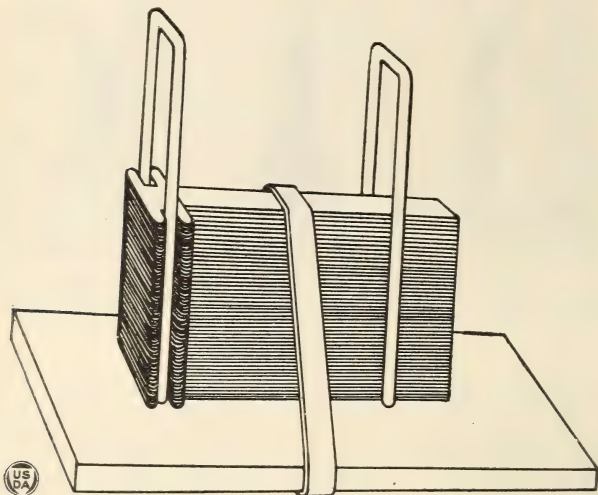
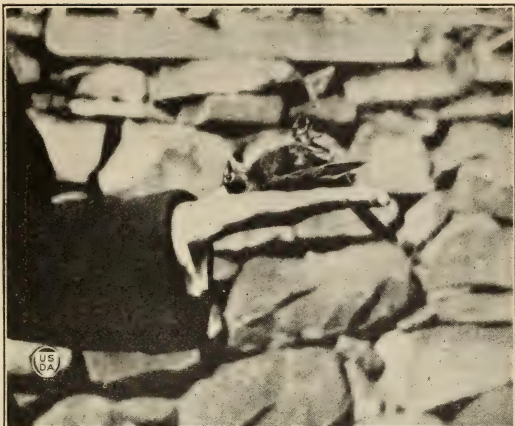

FIG. 24.—Holder for flat adjustable bands. The inverted U that passes between the locking nibs should be about a half inch higher than the other.

REPORTS.

The Bureau of Biological Survey is the central agency for the bird-banding work, and all cooperators are expected to conform to the regulations prescribed. Cooperative regional associations are rendering efficient assistance by coordinating the activities of operators in different geographic areas, and it may be the desire of their officers to have certain reports made by their members. There is no objection to this, provided these reports are made supplementary to the ones forwarded to the central office.

Report banded birds frequently. Figure 27 shows a record card properly made out. Extensive files are required for this work, and it is of the utmost importance that they be at all times as up-to-date as possible. This can be achieved only by individual operators send-



B2298M

FIG. 25.—Banded robin lying on its back on outstretched hand. (See also Figure 26.) (Photograph by R. H. Howland.)



B2331M

FIG. 26.—Banded rose-breasted grosbeak remaining on open hand. (See also Figure 25.) (Photograph by George Roberts.)

ing in results and records regularly. Envelopes requiring no postage will be supplied for returning the record cards, which, during the busy seasons, should be forwarded at least once a month. The importance of promptness will be appreciated when it is considered that the "return" data of a bird banded at one station to-day and recovered at another station a short time later may be forwarded to the Biological Survey before the first record of banding is in proper place in the files.

When actually engaged in banding, be careful to write down the band number at once; do not trust to memory. It is well to carry to the traps a card for entering the name and number of each bird handled. Before attaching a band, note its number while opening it, and check up the record afterward. Small numbers of several figures should be read with the greatest care, as one may be more likely to make errors with small numbers than with large ones. A band

RECORD OF RECOVERY				REMARKS
DATE	LOCALITY	BY		
5/6/23	Same			
5/10/23	Same "C"			

RECORD OF BIRD Banded

No. 237483 SPECIES Robin ♂ ad.

WHERE Banded Washington, D.C.

DATE May 5, 1923 Banded BY John M. Jones

REMARKS National Zoo Park, Substation "B."
1 white feather in left wing.



Form B1-137

Fig. 27.—Record card properly filled out. The bird had "repeated" twice at different substations before the card was sent in.

read wrongly may totally disqualify what otherwise would be a most valuable report. *Be particularly careful with "returns," especially if the bird was banded at another station.*

Each cooperator should keep a permanent record of his operations, so that his reports can be checked up and verified at any time. As reports will be made from this permanent record, it will be well also to note in it such items as the actions of the bird in the trap or in the hand; whether it seems unduly alarmed, fights, or squeals; whether there is an excessive number of body or feather parasites; malformations or peculiar color patterns; and any other features of interest. A file of cards 3 by 5 inches in size is excellent for this purpose. Or, a loose-leaf system with a separate page for each bird is good.

Complete station reports, containing all records of "repeats" and "returns," should be sent to the Biological Survey semiannually. It is not desirable to have such information reported more frequently. During slack seasons cooperators probably will compile their station

records for their own information. A copy of this record should then be sent to the Biological Survey. The following form of report is easily compiled, and would be of the most value to the bureau:

TRAPPING STATION REPORT.

Operator: *John M. Jones.*

Location: *National Zoological Park, Washington, D. C.*

Period covered: *October 1, 1922, to April 1, 1923.*

Substations: "A"—*Government sparrow trap, at edge of woods, near bison inclosure; dogwood and other shrubs at one side.* "B"—*drop trap, operated back of keeper's house, 40 feet from large trees.* "C"—*Group of four false-bottom traps, in ornamental shrubbery behind administration building.*

Returns.

45703, Robin (banded Apr. 13, 1922); recaptured Mar. 26, 1923, Substation "A."

Repeats.

90347, Song sparrow (banded Sept. 27); Oct. 2—C; 6—C; 13—C; 14—C; 19—C; 30—A (forehead bruised); Nov. 3—A (forehead healed); 4—A (2); 7—C; 8—A, C; etc.

90361, White-throated sparrow (banded Oct. 1); Oct. 10—B; 15—B; 16—B (3); 17—B (2); 18—B (4); 20—B; 27—B (2), C; etc.

90374, White-throated sparrow (banded Dec. 19); Dec. 21—C; 23—C; 26—C; Jan. 4—C; 5—C; 6—C; etc.

96377, Cardinal (banded Feb. 12); Feb. 23—A; 25—A; 26—A; Mar. 6—B; 15—B (2); 21—A; etc.

FIG. 28.—Specimen station report. (Note that band numbers are entered in numerical order.)

Supplementary notes regarding the weather, available natural food supply, relative abundance of the different species, etc., during the period covered, are often of much value both to the bureau and to the cooperator.

Distinguish between "repeats" and "returns." The term "repeat" is used to designate a short-time return at the original station. It is used in case of recoveries of banded birds that have apparently not been absent from the immediate neighborhood since the time they were last handled. Some birds acquire the "trap habit," and repeat frequently. Such reports, when pertaining to migratory species, may provide exact information regarding the time that migration commences. Sedentary species may perhaps repeat continuously throughout the year. Every "repeat" should be reported.

The term "return" is used to designate a recovery from the original or any other station after or during a migratory period, except that any banded bird meeting accidental death at or close by the station where it was banded *should always be reported as a "return."* Returns may occur at the original station after migration by having

the banded birds come back to the same neighborhood they were in the previous season, by recapturing birds banded at other stations, or by accidental deaths. Trapping stations are likely to get most of their "returns" from birds banded at the station in previous seasons. Migratory game birds are usually reported from other places.

LITERATURE.

Among the more important American papers on bird banding are the following:

BALDWIN, S. PRENTISS.

- 1919. Bird banding by means of systematic trapping: *Abstr. Proc. Linnaean Soc. New York*, no. 31, pp. 23-56, pls. 1-7.
- 1921a. Recent returns from trapping and banding birds: *The Auk*, vol. 38, no. 2, pp. 228-237, April.
- 1921b. The marriage relations of the house wren: *The Auk*, vol. 38, no. 2, pp. 237-244, April.
- 1922. Adventures in bird banding in 1921: *The Auk*, vol. 39, no. 2, pp. 210-224, pls. 8-9, April.

BARTSCH, PAUL.

- 1904. Notes on the herons of the District of Columbia: *Smiths. Misc. Coll.*, vol. 45, Quart. Issue, vol. 1, pp. 104-111, pls. 32-38.

CLEAVES, HOWARD H.

- 1913. What the American Bird Banding Association has accomplished during 1912: *The Auk*, vol. 30, no. 2, pp. 248-261, pls. 7-8, April. (Reprinted in *Ann. Rept. Smiths. Inst. for 1913*, pp. 469-479, 1914.)

COLE, LEON J.

- 1903. Suggestions for a method of studying the migrations of birds: *Bul. Michigan Orn. Club*, vol. 4, no. 1, pp. 19-22, March.
- 1909. The tagging of wild birds as a means of studying their movements: *The Auk*, vol. 26, no. 2, pp. 137-143, April.
- 1910. The tagging of wild birds; report of progress in 1909: *The Auk*, vol. 27, no. 2, pp. 153-168, figs. 1-2, April.
- 1922. The early history of bird banding in America: *Wilson Bulletin*, vol. 34, no. 2, pp. 108-115, June.

LINCOLN, FREDERICK C.

- 1921a. The history and purposes of bird banding: *The Auk*, vol. 38, no. 2, pp. 217-228, April.
- 1921b. Instructions for bird banding: *U. S. Dept. Agr. Circ. no. 170*, pp. 19, figs. 11, April.
- 1922a. Knowledge gained from banding migratory waterfowl: *Bul. Amer. Game Protective Association*, vol. 11, no. 2, pp. 12-13, illus., April.
- 1922b. Trapping ducks for banding purposes: *The Auk*, vol. 39, no. 3, pp. 322-334, pls. 11-14, July.

MUSSELMAN, T. E.

- 1923. Bird banding at Thomasville, Ga., 1923: *The Auk*, vol. 40, no. 3, pp. 442-452, pls. 25-27, July.

OSBERHOLSER, HARRY C.

- 1923. Bird banding as an aid to the study of migration: *The Auk*, vol. 40, no. 3, pp. 436-441, July.

STONER, DAYTON.

- 1921. Bird banding and incidental studies: *Proc. Iowa Academy of Science*, vol. 28, pp. 151-159, figs. 27-29.

TALBOTT, L. R.

- 1922. Bird banding at Thomasville, Ga., in 1922: *The Auk*, vol. 39, no. 3, pp. 334-350, pls. 15-17, July.

TAVERNER, P. A.

- 1904. The tagging of birds: *Bul. Michigan Orn. Club*, vol. 5, no. 2, pp. 50-51, June.

In addition to the above papers, the student of bird banding will find in the recent volumes of *The Auk*, *The Condor*, and *The Wilson Bulletin* numerous notes and papers that deal with bird-banding methods and results.

PROBLEMS THAT CAN BE SOLVED BY BIRD BANDING OPERATIONS.

1. How fast do the individuals of any species travel on their periodic migrations; that is, how many miles per day will any one bird average during these journeys and what is the total time consumed in a trip?

2. Does any one flock continue in the van, or is the advance made by successive flocks passing one over the other in alternate periods of rest and flight?

3. Do individuals of any species always follow the same route, and is the route the same for both spring and fall flights?

4. Do migrating birds make the same stop-overs every year to feed?

5. How long do birds remain in one locality during the migration, the breeding, or the winter season?

6. What is the relation between the breeding and the wintering grounds of individuals; that is, do those birds that breed farthest north winter farthest south, thus jumping over those that occupy the intermediate zone, or do they merely replace the latter individuals as winter residents?

7. Do birds adopt the same nesting area, nest site, and winter quarters in successive seasons?

8. For how many broods will one pair remain mated, and which bird, if not both, is attracted next year to the old nesting site?

9. To what extent do males of a species assist in incubation and brooding?

10. How far from their nests do birds forage for food, and after the young have left the nest, will the parent birds bring them to the feeding and trapping station?

11. To what region do the birds go, particularly the young, that do not return to the vicinity of their original nests?

12. How long do birds live?

For solving these and related problems, it is important that the traps always be set on the original site, for certain birds already have returned to the same traps through five or six consecutive seasons. Many "returns" will, in the course of time, furnish answers to the important problems stated above.

PUBLICATIONS OF THE UNITED STATES DEPARTMENT OF AGRICULTURE ON THE DISTRIBUTION AND MIGRATION OF BIRDS.

FOR FREE DISTRIBUTION BY THE DEPARTMENT.

- Bird Migration. (Department Bulletin 185.)
Migration Records from Ducks and other Birds Banded in the Salt Lake Valley, Utah. (Department Bulletin 1145.)
Report on Bird Censuses in the United States, 1916-1920. (Department Bulletin 1165.)
Community Bird Refuges. (Farmers' Bulletin 1239.)
Distribution and Migration of North American Shorebirds. (Biological Survey Bulletin 35.)
Local Names of Migratory Game Birds. (Miscellaneous Circular 13.)
The Great Plains Waterfowl Breeding Grounds and Their Protection. (Yearbook Separate 723.)
Federal Protection of Migratory Birds. (Yearbook Separate 785.)
Conserving Our Wild Animals and Birds. (Yearbook Separate 836.)
The Purpose of Bird Censuses and How to Take Them. (Department Circular 261.)
Migratory Bird Treaty, Act, and Regulations. (Service and Regulatory Announcement, B. S. 48.)

FOR SALE BY THE SUPERINTENDENT OF DOCUMENTS, GOVERNMENT PRINTING OFFICE, WASHINGTON, D. C.

Fifty Common Birds of Farm and Orchard. (Farmers' Bulletin 513—with 50 colored illustrations.) Price, 15 cents.

OUT OF PRINT.¹

- Distribution and Migration of North American Warblers. (Biological Survey Bulletin 18.)
Distribution and Migration of North American Ducks, Geese, and Swans. (Biological Survey Bulletin 26.)
Distribution and Migration of North American Herons and Their Allies. (Biological Survey Bulletin 45.)
Distribution and Migration of North American Rails and Their Allies. (Department Bulletin 128.)
Distribution and Migration of North American Gulls and Their Allies. (Department Bulletin 292.)
Distribution of American Egrets. (Biological Survey Circular 84.)

¹ Publications out of print may be consulted at many libraries, or possibly may be purchased of dealers in second-hand books on ornithology.

ADDITIONAL COPIES

OF THIS PUBLICATION MAY BE PROCURED FROM
THE SUPERINTENDENT OF DOCUMENTS
GOVERNMENT PRINTING OFFICE
WASHINGTON, D. C.
AT
10 CENTS PER COPY



RECEIVED

★ OCT 1 1929 ★

U. S. Department of Agriculture

UNITED STATES DEPARTMENT OF AGRICULTURE

MISCELLANEOUS CIRCULAR NO. 19

WASHINGTON, D. C.

APRIL, 1924

FOREST FIRES IN THE INTERMOUNTAIN REGION

PREPARED BY THE INTERMOUNTAIN DISTRICT OF THE FOREST SERVICE



FIG. 1.—“Only a brush fire.” Such fires are frequent in the intermountain region and destroy thousands of seedlings.

Each year in the intermountain region there are from 400 to 700 forest fires, many of which are caused by human carelessness. They burn large areas and destroy natural resources worth many thousands of dollars. Forest fires are not popularly regarded as serious in this region because the immediate damage is much less than in the Northwest, where extremely valuable timber stands may be

destroyed by them. The indirect damage from forest fires in this region is tremendous, however, and strikes at the very root of the prosperity of the intermountain region by threatening the permanence of water supplies so necessary to agriculture and to the life of cities and towns, to say nothing of the losses in timber and the destruction of forage resources. In order to combat these fires a large force of men is required. If the public would realize its responsibility for forest fires, nearly half of them could be prevented, and the Federal Government would be relieved of the burden of maintaining a fire-fighting organization of such proportions as is now necessary. At the same time, the damage done would be greatly decreased.

THE IMPORTANCE OF FIRES.

Down the city street comes the wild clang of a gong and the roar of heavy wheels. Nearer and nearer come the trucks at full speed, while automobiles and pedestrians scatter before them. Everything gives way to the fire department as it speeds to the fire. Perhaps we, too, hurry along with the crowd in the direction it has gone and watch the men as they work with the powerful engines, high ladders, and great streams of water to put out the flames that are destroying the stores and homes men have labored hard to build and the merchandise they have struggled to acquire. "Good they got here when they did," we say to our neighbors standing near, "or the whole thing would have burned up." "Must have lost a thousand dollars as it is," someone replies.

Similar scenes on a smaller scale are common in towns and villages, where the clanging of the fire bell arouses the volunteer fire fighters. They rush out the hose and hurry to the scene of the fire, bending every energy to prevent the flames from destroying valuable property.

Smoke appears back in the mountains, billowing up over the distant ridges and spreading hazily across the sky. Who gets excited? Who worries about the damages being done back there? Very few. "Just a brush fire—a few worthless trees maybe," we say to our neighbor. "We have always had brush fires. They can't be prevented, and they don't really do any harm. Of course, those big forest fires in the Northwest are a different thing. But these—these don't amount to anything."

Back in the mountains, however, are the men who know better. A lone lookout in his little cabin on some high barren mountain peak, incessantly scanning the country, sees the tiny, far-away wisp of smoke. He telephones to others. The fire is definitely located, and in a few minutes fire fighters on horseback are off across the canyons and mountains to the fire. No clanging of gongs here, no speed and rush, no spectacular thrills, no admiring throngs. It is just simple hard work with axe and shovel out in the distant mountains, putting out a fire about which few people care. It cost nobody money to clothe these hills with brush or to put those trees there. Nobody expects to get much money out of those forests. Their destruction seems to hit nobody's pocket book. But is it really true that nobody's pocketbook is hit? Let us look further.

NUMBER AND SIZE OF FIRES IN THE INTERMOUNTAIN REGION.

The intermountain region is popularly regarded as one in which forest fires are few and very small. It is true that this region has never suffered any such great conflagrations as have occurred from time to time in Michigan, Minnesota, and the Northwest. This broken mountainous country lacks the great continuous bodies of timber found in other regions, and fires start somewhat less easily and spread over less extensive areas. Nevertheless, in ordinary years from 400 to 500 forest fires occur here annually, and sometimes, as in 1919, there may be more than 700 fires in this region, popularly supposed to be almost without fire hazard. In the summer time, when smoke drifts in, it is commonly believed that all the fires are in northern Idaho and the far Northwest, for those fires are the ones that attain newspaper prominence. Nevertheless, in the 15 years the Forest Service has been fighting forest fires and keeping records in this region, 606,279 acres have been burned over. This is proof enough that the forests are very inflammable, and that tremendous fires can start and extend over large areas. In 1910, when weather conditions were very bad, fires covered several hundred thousand acres in this region. It is perfectly possible that such conditions may be repeated.

Consider what the burning of 600,000 acres of forested lands means. This area is practically 1,000 square miles—a territory almost as large as Cache County in Utah, or Ada or Bear Lake Counties in Idaho. Imagine an entire county devastated by fire, left desolate and barren. This is what forest fires mean in this region, and each year the area is being added to—a few thousand acres annually.

Figure 2 shows that the number of fires varies in different parts of the region, the worst situation existing in western Idaho. It would be an unwarranted conclusion from this showing that on the Utah and Nevada National Forests fires are so unlikely to occur that no efforts need be made to prevent or suppress them. Even within the last few years, with the Forest Service constantly on the alert, an area of about 10,000 acres was burned over in one year on the Cache National Forest near the Utah-Idaho line; and in Nevada, a State usually marked by very few and small forest fires, 3,000 acres were swept by flames on the Humboldt National Forest in one year. Throughout this region of southeastern Idaho and of Utah and Nevada, barren areas that testify eloquently of ancient fires are not hard to find. Furthermore, men who have studied the problem carefully say that the great stretches of quaking aspen found throughout the mountains of this region all show the marks of early fires, and, indeed, that these aspen stands owe their existence to such fires.

Lodgepole pine, too, is a species which almost always comes in on old burns. Vast areas in western Wyoming and southeastern Idaho are covered with trees of this species to the exclusion of all else. Nearly all these areas, too, are believed to mark ancient burns. Out of a total of about 18,000,000 acres covered with forest in this

intermountain region about 4,500,000 acres are covered with lodge-pole pine and 2,000,000 with aspen. This seems to indicate that about one-third of the area has been burned over at some time. Without question these forests are very inflammable, and tremendous conflagrations will develop in them if fires are given a chance to start. This inflammability is not a condition of the past, but exists now.



FIG. 2.

Not long ago, on the Teton National Forest in western Wyoming, rangers, who were burning brush after a foot of snow had come on the ground, found that the fire would run in the dry duff and litter under the snow, and that, if it reached some distant dry stump, would generate enough heat to send up a column of smoke and steam over the area of the fire. One can readily imagine what would happen in a country like this in the heat of midsummer.

WHAT CAUSES THE FIRES.

There is a general belief that forest fires are nearly always started by something beyond the power of man to prevent, such as lightning, dry limbs rubbing together in the wind, or broken bottles acting as lenses to concentrate the rays of the sun. Nothing could be further from the truth. There are only two causes of forest fires in this

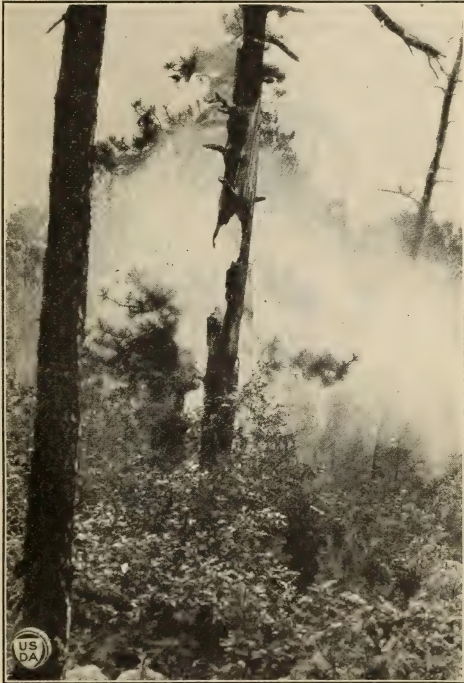

FIG. 3.—Fires started by lightning are unavoidable; those started by man are inexcusable.

region. They are human carelessness and lightning. Of the two, human carelessness is responsible for the greater number, as less than half of the fires in the intermountain region are caused by lightning (fig. 3). Records of the past 15 years show that 47 per cent resulted from lightning, 35 per cent from the carelessness of campers, 6 per cent from brush burning in which the fire was allowed to escape, 5 per cent from locomotive sparks, 4 per cent from

miscellaneous unlisted causes, 2 per cent from incendiarism, and 1 per cent from the carelessness of lumbermen.

Lightning fires are not distributed evenly over all the intermountain region. Figure 4 shows the percentage of fires caused by lightning in the different parts of this region. In western Idaho lightning-caused fires are most frequent, forming 62 per cent of all the fires. In eastern Idaho lightning causes only 21 per cent of the fires. In the high mountains of western Wyoming about one-third, in



FIG. 4.

Utah about one-fourth, and in Nevada about one-tenth of the fires are due to lightning.

Compare lightning with the careless camper as a cause of forest fires. In southeastern Idaho campers are responsible for about three times as many fires as lightning, and in Nevada for nearly four times as many. In western Wyoming nearly two-thirds of all fires are caused by campers and only about one-third by lightning. It is only in the forests of western Idaho that lightning is more active than

careless campers in starting fires. Here about two-thirds of the fires are caused by lightning and only about one-fourth by campers.

It must be remembered in the above statements that only one kind of human carelessness—that of campers—has been mentioned. Sparks from locomotives, brush burning, and other agencies controlled by people make a further addition to the list of fires caused by human beings. It is obvious that if people would be careful with fire in the woods the fire problem would practically be solved, except in a few forests of western Idaho, where lightning is, indeed, a very serious proposition. Taking the intermountain region as a whole, human beings constitute a much greater problem than any other agency where forest fires are concerned. On more than three-quarters of the area the danger from persons far outweighs the danger from lightning.

In some forests of the country the human problem is largely the problem of the incendiary, who sets fire to the forests when conditions are the very worst and who is accordingly very destructive. The intermountain region, fortunately, is almost free of the "fire-bug," incendiary fires averaging only about 2 per year for the whole region. People of the intermountain country generally realize that the effects are deplorable, although they are prone to underestimate the damage which is done. Accordingly, incendiary fires in this region are rare except in Nevada, where 6 per cent of the fires are of this character. This is largely explained by the fact, disclosed in records that are an average for the past 15 years, that there has been some incendiarism on the part of grazers who have thought that burning the range improved forage conditions. This belief has now been overcome, and the forest fire started by intention is becoming more rare. Human carelessness, then, is the big problem. It necessitates a large fire-fighting force and much special work, not only in putting out but also in preventing forest fires.

DAMAGE DONE BY FOREST FIRES.

It is a very difficult thing indeed to estimate exactly, in dollars and cents, the damage from a forest fire. It is relatively easy to estimate the amount of timber destroyed; but if the timber was standing in distant and inaccessible valleys where it probably would not have been cut for many years it is difficult to put a price upon it. It is still more difficult to value the forage destroyed. These are the most obvious of the losses, and they are comparable to the losses an insurance adjuster examines into when a city building burns. Once the building is destroyed, however, the damage is done. The insurance is paid, and probably a building better than the first arises to take its place. It is different with the forest fire. When the first damage has been done the real destruction has just begun. In forestry the present crop of timber is not the only thing to deal with, but generations of little trees yet to come must be considered, also, the forage conditions as they will be next year, the year after, and for many years after that. Finally, the earth itself on the burned-over areas must be considered. In this region of irrigated farms the value of the timber and forage is by no means the greatest

of all the values which the forest possesses. "The irrigation water, the very life blood of the region, depends upon the proper covering of the watersheds. Destroy the forest, and the irrigated farming, together with the visible timber and forage, is destroyed.

TIMBER VALUES DESTROYED.

The difficulty of putting a value in dollars and cents upon the timber destroyed arises partly from the fact that some of the timber is remote and has little present commercial value. Nevertheless, it will all have value at some time, and a high value at that, because a period of timber shortage is approaching.

Timber is being sold for about \$3 per thousand feet. It does not, therefore, seem out of the way to place a value of about \$1.25 per thousand feet on the timber which is annually destroyed by fire.



FIG. 5.—Desolation follows fire.

Looking over the records for the past 15 years it is seen that forest fires in this region have destroyed practically 600,000,000 feet of timber. This is as much timber as there is on some of the national forests, and it means a tremendous loss both now and for the future. The value of this timber amounts to about \$750,000 at the conservative figure of \$1.25 per thousand feet.

At the same time that present timber values are being destroyed the fires are wiping out vast amounts of reproduction, the little trees that would some day have made good stands of timber for the people of the future, who will probably need timber fully as much, and perhaps more than we do now. What people will be paying for it in a hundred years can not be estimated, and therefore it is impossible to say what it is worth now. Even if timber were estimated to be no more valuable than it is now, we find that forest fires during the last 15 years have destroyed reproduction valued at \$500,000.

Much more is really being lost, however, than is indicated by these figures. Consider, for example, some of the brush fires which so frequently occur in the foothills. They run through sagebrush or oak, and it is often thought they do no damage. In a great many places it will be found that little trees only a few inches high, standing perhaps hundreds of feet from their parents, were destroyed by some one of these fires. It is hard for evergreen trees to gain a foothold on these brushy areas. Their seed may be sown annually for many years by parent trees, and yet the whole result will be only a scattering growth of little trees. One fire may undo the work of a score of years. When the fire is over the older trees again renew their work of broadcasting seed. It may happen that within the next 10 or 15 years enough favorable seasons will occur to allow a meager scattering of little trees to start again on the old burn. Once more the brush comes in, inflammable *débris* accumulates, a careless human being comes by with a match, and the process starts all over again. In time the old parent trees die and fall, leaving no progeny, and the brushwood extends a little farther into the mountains. (Fig. 5.)

The forests are constantly trying to extend themselves into the brush lands which produce no timber. To the extent to which they succeed they are increasing the productive areas naturally. All they want is a chance, but fires once in 20 to 30 years are able to put a stop to this entire process. The resultant loss is difficult to estimate.

LOSS OF FORAGE VALUE.

Forest fires do not destroy forage values far into the future in the way forests are destroyed. Nevertheless, they destroy the growth of the present year and sometimes that for several years to come. During the last 14 years \$50,000 worth of forage has been destroyed in the intermountain region. This means the grazing for about 75,000 cattle for one year. Seventy-five thousand is a large number of cattle, and the destruction of forage for so much stock means a great deal in this region, even if the next year's crop comes on all right.

LOSS OF WATERSHED PROTECTION.

The values previously discussed are very real, and their loss can be appreciated by everyone. Much less apparent, but really worst of all, are the losses that come through the destruction of watershed protection. The greater part of the intermountain region depends upon irrigation for its prosperity, and the degree to which this region flourishes depends in a very large measure upon the amount, the evenness of the flow, and the clearness of this water. There must be plentiful supplies so that the water will cover the maximum amount of ground. It must flow as evenly as possible through the season so that crops will not suffer through lack of late water. It must be reasonably clear water, because water which carries a large amount of sediment clogs up dams, ditches, and canals, fills reservoirs, and makes irrigation so expensive that its benefits are more than offset by its cost.

The flow of water from the mountain streams would not cease even if all forests and vegetation were removed from the mountain sides. The snow banks would continue to pile up, the heavy rains of sum-



FIG. 6.—The forest untouched by fire.

mer would still fall profusely on all these high mountain ranges, and the mountain streams would continue to be the main means of watering the valleys. Nevertheless, under these circumstances, the total amount of usable water reaching the valleys would be less. It is cer-

tain that one rush of water would come down in the spring and that the streams would dwindle away to nothing in the summer, except when some heavy summer storm caused another rush of water and a local flood. It is also clear that the water would carry with it tremendous amounts of loose earth, rocks, and sediment of all kinds. Under these circumstances, the usefulness of reservoirs would be impaired, the cost of maintaining canals and ditches would be excessive, and the amount of usable water would be greatly reduced. Probably half of the wonderful agricultural values of this region that have been built up through irrigation would disappear. If the amount representing this loss be divided by the number of acres from which irrigation water is secured in this district, it is found that the value of a well-protected watershed amounts to something like \$8 an acre. During the last 14 years 602,000 acres have been burned over whose value for watershed protection at this rate would be nearly \$5,000,000.

It is not often that all of this value is lost permanently, however, for nature always "stages a comeback" and tries to restore a cover of vegetation to the denuded hillsides. But, although in 5, 10, or 20 years, depending upon the location of the burn, the new cover may afford a degree of protection to the watersheds, the full protection of a mature forest is not regained for many years. Through southern Idaho and central Utah, where the forests are least thrifty and the climate is driest, the process of reforestation is slow indeed. The greatest losses occur, therefore, in the region where they can be afforded least.

There is still another form of loss, and although its value is very hard to reckon in money, it is perhaps the one most keenly felt by most of the public. This is the loss of recreational values. The forests are loved for their own sakes, for the beautiful scenery contained in them, and there is a very keen sense of disappointment and loss when these playgrounds are found burned, blackened, and destroyed. The camper who has once spent a happy vacation in some tree-filled hollow feels a sense of personal loss when he comes again upon the place and finds only a few blackened snags and a dirty mud-filled stream. This loss outweighs in his mind the loss of timber, watershed protection, and everything else. It is hard to say what this recreational use of the forest is worth in money, but the value is very real.

Fires destroy hunting of all kinds. Wild animals find their forage destroyed and their hiding places left open. The game birds can find no food and no hidden places in which to nest and rear their young. The naked soil is washed into the streams after the first rain and carries with it lye from the leached ashes, which kills the fish and renders the streams unsuitable for their propagation for many years. In this way fires at the headwaters of the Salmon River, where the salmon spawn, are capable of exercising a very real influence upon the salmon industry of the Pacific coast. The average fisherman, however, who goes out into the woods to fish, feels more keenly his personal loss. He would willingly go without canned salmon forever if he could find a well-stocked stream flowing through an attractive country in which to camp.

WHAT IS BEING DONE TO REDUCE FOREST FIRES.

In several of the small towns in the intermountain region where forest fires are most frequent and dangerous you will find special offices of the Forest Service. These are fire dispatchers' offices. Drop in some hot summer afternoon and see what sort of a place you have there for the protection of your forests. You will see no shining brass of powerful engines, no hose, no ladders, or other tools of the city fire fighter—just a small room with many maps on the wall, and a big desk where a man sits with a telephone close at hand. Perhaps quiet reigns, and you may find the fire dispatcher in charge glad to talk with you. Soon the telephone bell rings. You can gather from the one side of the conversation that Ranger Black is on his way down to the Johnson corral, if anybody wants to know where he is. Then from another call it seems that Tiptop lookout wants some potatoes and kerosene as soon as possible.



FIG. 7.—Operating a fire finder under difficulties.

Tiptop is 60 miles away and 5,000 feet above the surrounding valleys. The dispatcher suspends his talk with you while he calls the storekeeper in another town and tells him to be sure to include kerosene and "spuds" in the order going out by pack train early next morning, carrying supplies to all the "back country." Another call comes.

"What's that—106?" snaps the fire dispatcher, "Fork of Bear Creek?" You know by

his manner that something different has come over the wire. "Yes; Lone Peak ought to see that. I'll call them." And he hangs up.

"Fire up Bear Creek way. Smoke coming up pretty good," he says as he cranks the telephone.

"Hello, Lone Peak? * * * Oh, just trying to get me, were you? * * * Yes; Tiptop reports it on 106. * * * Three twenty-eight for you, is it? * * * All right; we'll have somebody after it right away."

He hangs up the receiver and goes to a map, where he takes two threads, one fastened at Lone Peak and one at Tiptop. Around each of these points is a circle graduated into 360°. He swings the threads so that the one from Tiptop cuts the circle at 106°, and the one from Lone Peak cuts its circle at 328°. The two lines cross at a point down near the forks of Bear Creek, just as Tiptop judged. Again the dispatcher sits down at his telephone. He gets "Smoke-chaser" Smith.

"Smith," he says, "there's a fire down on the mountain between the forks of Bear Creek. Tiptop and Lone Peak both see it, and it

seems to be starting pretty lively. Get down there as fast as you can. Pick up the prospector, Owens, if you can find him at his place, and take him along. If the fire looks bad, send him over to Deer Hollow for the crew that's building trail there. You stay right with the fire. The lookouts will keep us posted. If you can't get Tools, and if it gets worse, we will get the trail crew in to help you."

Next he intercepts Ranger Black, through the kindness of Mrs. Holcomb, whose ranch he must pass on his way to Johnson's corral. He informs him of the fire and tells him to be ready to shoot in reinforcements, for the weather is hot and dry and the place dangerous. Then for a time all is quiet again. The lookouts in an hour or so may report the smoke abating or may be getting worse. Then there is more telephoning. Men are notified at distant ranches. Tools, rations, camp outfits, cooking utensils, all prepared in units for just such times, are pulled out of the storehouses, packed onto

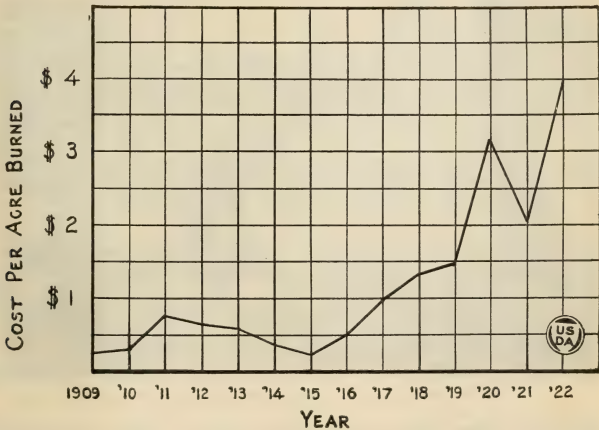

FIG. 8.

horses' backs in a few minutes, and are soon off across the mountains. An organization, complete in all details, arises as if by magic through the agency of the telephone. The fire is directed from perhaps 60 miles away by a man who never sees the flame or even smells the smoke, and who may not even know the fire-fighters except as distant voices at the other end of the wire. All night long the dispatcher may sit at his desk, calling here and there, and listening to reports. Out in the forest the men are working or resting, ready to jump on the fire at the first glimmer of morning light.

This is what is being done to stop forest fires. The United States Forest Service and the South Idaho Timber Protective Association (an organization of owners of private timber land, which also includes the State of Idaho as a member) both have built up organizations for controlling forest fires. Not in all parts of the intermountain region is the organization so complete as pictured above. Every-

where, however, are fire detection and suppression organizations competent to handle effectively the fires starting in the region. In 1910, when the organization was young, in a season of extreme fire hazard, 384 fires burned over 193,742 acres. Nine years later came another hot, dry year, and an area of approximately the same extent was burned over, 192,888 acres. There were, however, 704 fires to cope with, nearly double the number that occurred in 1910. The year 1909 was an easy year, with only 152 fires and only 4,455 acres burned. The year 1922 was not a bad fire season either. The fire-fighting organization was much more effective, however, and 542 fires covered an area of only 3,652 acres. There were over three times as many fires as in 1909, but a smaller area was burned. The organization is doing good work, is improving every year, and is a powerful factor in reducing fire losses.

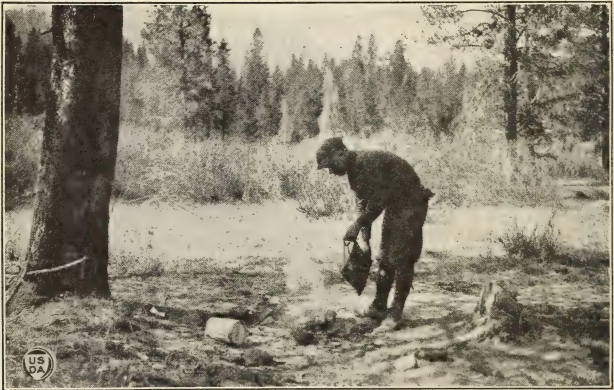

FIG. 9.—Putting out a camp fire left by careless campers.

But such things cost money. Figure 8 shows how the cost per acre burned over each year has risen from 1909 to the present time. The area burned over is being reduced each year, but at considerable expense. Still, so long as the fires are started, there is no other way by which protection can be achieved. If the human element could be done away with, or even greatly reduced, matters would be very much improved, for it is the fires caused by human beings that give the fire-fighting forces the most trouble. Lightning fires start frequently upon high ridges or places where isolated dead trees stand out boldly. Such places are easily seen by the lookouts, and fires do not readily spread on the rock tops of high ridges. Fires started by human beings are at first almost always hidden away along some trail or stream in the canyon bottoms or at the foot of slopes where the fire can quickly assume a large size.

The most logical thing to do is to get rid of fires started by human beings. Campers start the greatest number of man-caused fires. They must learn to be careful with fire in the mountains if the de-

struction is to be stopped, and if the cost of fire-fighting is to be reduced. (Fig. 9.)

From Figure 10 it is seen that progress is being made along this line, as the percentage of fires caused by human beings shows a

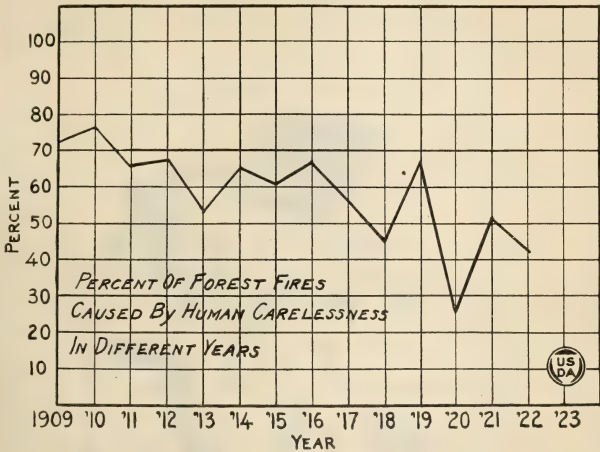

FIG. 10.

downward trend year by year. The whole future of forest protection in this region depends upon the reduction of man-made fires, as lightning is a very small factor. This object can be achieved if every person who goes into the forest will carefully observe the following six rules:

1. **MATCHES.** Be sure your match is out. Break it in two before you throw it away.
2. **TOBACCO.** Throw pipe ashes and cigar or cigarette stumps in the dust of the road and stamp or pinch out the fire before leaving them. Don't throw them into brush, leaves, or needles.
3. **MAKING CAMP.** Build a small camp fire. Build it in the open, not against a tree or log or near brush. Scrape away the trash from all around it.
4. **LEAVING CAMP.** Never leave a camp fire, even for a short time, without quenching it with water or earth.
5. **BONFIRES.** Never build bonfires in windy weather or where there is the slightest danger of their escaping from control.
6. **FIGHTING FIRES.** If you find a fire, try to put it out. If you can't, get word of it at once to the nearest U. S. forest ranger. Keep in touch with the rangers.

Use care! Figure 11 shows what might be done. In 1922 public carefulness would have reduced the number of fires in all the regions except western Idaho to a very small number of lightning fires, a problem easy to deal with. The public is learning to be careful, but the national forests are becoming more and more popular; people



FIG. 11.

from the Middle West are coming in with their cars, people who never saw a forest, who know nothing of forest fires. The story of the disastrous consequences of forest fires must go to every person in this region, and the readers of this pamphlet are expected to help spread the message.

UNITED STATES DEPARTMENT OF AGRICULTURE

MISCELLANEOUS CIRCULAR No. 20

WASHINGTON, D. C.

DECEMBER, 1923

CROP REPORT REGULATIONS.

REGULATIONS GOVERNING THE PUBLICATION OF REPORTS AND THE INFORMATION UTILIZED IN THE COMPILATION OF REPORTS, PREPARED BY THE BUREAU OF AGRICULTURAL ECONOMICS, CONCERNING ACREAGES, CONDITIONS, YIELDS, FARM RESERVES, OR QUALITY OF PRODUCTS OF THE SOIL GROWN WITHIN THE UNITED STATES.

These regulations shall be effective on and after January 1, 1924.

Regulation 1.—During the year 1924 the Bureau of Agricultural Economics shall publish on dates hereinafter specified, unless other dates within the particular months be prescribed by amendment to these regulations, and in the manner hereinafter specified, reports concerning the acreages, conditions, yields, farm reserves, or quality of products of the soil grown within the United States as follows:

1. On Friday, January 25, 1924, 2.15 p. m., reports on number and value of farm animals.
2. On Monday, March 10, 1924, 2.15 p. m., reports on stocks on farms and shipments of corn, wheat, oats, and barley.
3. On Tuesday, ~~March 18, 1924,~~ 2.15 p. m., reports on intentions to plant spring-sown crops, ~~including cotton.~~
4. On Wednesday, April 9, 1924, 2.15 p. m., reports on condition of winter wheat and rye.
5. On Thursday, May 8, 1924, 2.15 p. m., reports on area remaining for harvest, and condition of winter wheat and rye; stocks of hay on farms; condition of hay, pasture, and progress of plowing and planting.
6. On Monday, June 2, 1924, 11 a. m., reports on condition of cotton.
7. On Monday, June 9, 1924, 2.15 p. m., reports on acreage of spring wheat, oats, barley; condition of winter wheat, spring wheat, oats, barley, rye, hay, apples, and peaches.
8. On Wednesday, July 2, 1924, 12.30 p. m., reports on acreage and condition of cotton.
9. On Wednesday, July 9, 1924, 2.15 p. m., reports on stocks of wheat on farms; acreage and condition of corn, potatoes, sweet potatoes, tobacco, flax, rice; condition of winter and spring wheat, oats, barley, rye, hay, apples, and peaches.
10. On Friday, August 1, 1924, 11 a. m., reports on condition of cotton.
11. On Friday, August 8, 1924, 2.15 p. m., reports on preliminary production of winter wheat and rye; stocks of oats and barley on farms; condition of corn, spring wheat, oats, barley, potatoes, sweet potatoes, tobacco, flax, rice, sugar beets, hay, apples, peaches, grain sorghums, peanuts; acreage and condition of buckwheat.
12. On Friday, August 15, 1924, 2.15 p. m., reports on intentions to plant winter wheat and rye.
13. On Tuesday, September 2, 1924, 11 a. m., reports on condition of cotton.

14. On Tuesday, September 9, 1924, 2.15 p. m., reports on condition of corn, spring wheat, oats, barley, buckwheat, potatoes, sweet potatoes, tobacco, flax, rice, hay, apples, peaches, sugar beets, grain sorghums, and peanuts.

15. On Thursday, October 2, 1924, 11 a. m., reports on condition of cotton.

16. On Wednesday, October 8, 1924, 2.15 p. m., reports on preliminary production of spring wheat, oats, barley, hay; condition of buckwheat, potatoes, sweet potatoes, tobacco, flax, rice, apples, pears, grain sorghums, sugar beets, and peanuts.

17. On Monday, November 3, 1924, 12 noon, reports on condition of cotton.

18. On Monday, November 10, 1924, 2.15 p. m., reports on preliminary production of corn, buckwheat, potatoes, sweet potatoes, tobacco, flaxseed, apples, pears, cranberries, grain sorghums, peanuts, clover seed, sorghum sirup, onions, and cabbage; condition of sugar beets; weight per measured bushel of grain.

19. On Friday, December 12, 1924, 2 p. m., reports on preliminary production of cotton.

20. On Tuesday, December 16, 1924, 4 p. m., reports on acreage, production, and value December 1, of corn, winter wheat, spring wheat, oats, barley, rye, buckwheat, flaxseed, rice, potatoes, sweet potatoes, hay, clover seed, tobacco, apples, peaches, pears, oranges, cranberries, sorghum for sirup, sugar beets, beans, grain sorghums, broom corn, peanuts, cowpeas, soy beans, hops, onions, and cabbage.

21. On Thursday, December 18, 1924, 2.15 p. m., reports on acreage and condition of winter wheat and rye.

Each of the reports hereinabove specified shall be published in the following manner:

On the day fixed for publication of each report the report or a synopsis thereof shall be made available at the office of the Secretary of Agriculture simultaneously to all persons there applying for the same.

During the year 1924 the Bureau of Agricultural Economics shall also publish, on each date or on the day following each date hereinafter specified, reports concerning acreages, conditions, yields, farm reserves, or quality, of products of the soil grown within the United States, as follows:

22. On Monday, March 10, 1924, reports on stocks on farms and shipments, of rye, hay, and potatoes.

23. On Wednesday, April 9, 1924, reports on condition (California and Florida) of potatoes, peaches, pears, pineapples, orange trees, lemon trees, lime trees, grapefruit trees, cabbage, tomatoes, celery, cauliflower, and pasture.

24. On Thursday, May 8, 1924, reports on condition (California and Florida) of potatoes, cabbage, tomatoes, cauliflower, peaches, pears, melons, pineapples, oranges, lemons, limes, grapefruit, apricots, almonds, and cherries; mortality and condition of farm animals.

25. On Monday, June 9, 1924, reports on acreage and condition of clover, timothy, alfalfa, sugar cane, pecans, velvet beans, edible peas; condition of cabbage, onions, pasture, peaches, pears, blackberries and raspberries, melons, sugar beets, tomatoes, pineapples, oranges, limes, lemons, grapefruit, apricots, plums, cherries, almonds, prunes, olives, and walnuts, for California and Florida.

26. On Wednesday, July 9, 1924, reports on acreage and condition of grain sorghums, broomcorn, hops, peanuts, sorghum for sirup, cowpeas, soy beans, edible beans; condition of timothy, clover, alfalfa, millet, pasture, sugar beets, tomatoes, cabbage, onions, edible peas, pecans, sugar cane, pears, grapes, blackberries and raspberries, and melons; lima beans, oranges, lemons, cherries, figs, plums, pineapples, limes, grapefruit, apricots, almonds, prunes, olives, and walnuts for California and Florida; weight per fleece of wool.

27. On Friday, August 8, 1924, reports on condition of broomcorn, hops, sorghum for sirup, cowpeas, soy beans, edible beans, timothy, clover, alfalfa, millet, pasture, tomatoes, cabbage, onions, edible peas, pecans, velvet beans, sugar cane, grapes, pears, blackberries and raspberries, and melons; lima beans, oranges, lemons, pineapples, limes, grapefruit, figs, plums, apricots, almonds, prunes, olives, walnuts, for California and Florida.

28. On Tuesday, September 9, 1924, reports on acreage and condition of clover seed and cranberries; production of timothy hay and seed, edible peas; condition of broomcorn, hops, sorghum for sirup, cowpeas, soy beans, edible beans, clover hay, alfalfa hay, millet, pasture, tomatoes, cabbage, onions, edible peas, grapes, pears, melons, pecans, velvet beans, sugar cane; peaches, oranges, lemons, limes, grapefruit, apricots, figs, plums, almonds, prunes, olives, lima beans, walnuts, for California and Florida.

29. On Wednesday, October 8, 1924, reports on preliminary production of clover hay, alfalfa hay and seed, broomcorn, hops, edible beans, tomatoes, cabbage, onions; condition of clover seed, pasture, cowpeas, soy beans, sorghum for sirup, pecans, velvet beans, sugar cane, grapes, pears, cranberries; lima beans, oranges, lemons, limes, grapefruit, figs, almonds, prunes, olives, walnuts, for California and Florida.

30. On Monday, November 10, 1924, reports on preliminary production of cowpeas, soy beans, grapes, velvet beans, pecans, sugar cane; condition or per cent of production of oranges, lemons, limes, grapefruit, figs, almonds, olives, walnuts, for California and Florida.

31. On Tuesday, December 16, 1924, reports on preliminary production of oranges, lemons, limes, grapefruit, for California and Florida.

Each of the reports hereinabove specified, or so much thereof as is practicable, shall be printed in a publication entitled "Weather, Crops, and Markets."

Regulation 2.—The contents and every part of the contents of each and every report specified in regulation 1, and the information and every part of the information utilized in the preparation of each and every such report, shall be withheld from publication until the time specified for the publication of the report by regulation 1 or such amendments thereto as may be made from time to time.

Regulation 3.—The Secretary of Agriculture, the Assistant Secretary of Agriculture, such person as may be designated for the time being as Acting Secretary of Agriculture, the Chief of the Bureau of Agricultural Economics, the Assistant Chief of the Bureau of Agricultural Economics, members of the Crop Reporting Board, and employees actually engaged at the time in aiding the Crop Reporting Board in the preparation of the particular report or reports shall be entitled to receive, in advance of the publication of each of the reports specified in regulation 1, information concerning the contents thereof, but no officer or employee of the Department of Agriculture, or person acting in any capacity under or by virtue of the authority of the Department of Agriculture who, by virtue of the office, employment, or position held by him, shall become possessed of any information concerning the acreages, conditions, yields, farm reserves, or quality, or any other information which might exert an influence upon or affect the market value of any products of the soil dealt with by the Bureau of Agricultural Economics and specified in regulation 1, shall willfully impart such information, or any part thereof, directly or indirectly, before the official release of such information to the public, to any other officer or employee of the Department of Agriculture, or person acting in any capacity under or by virtue of the authority of the Department of Agriculture, excepting the officers and employees of the Department of Agriculture hereinbefore named as entitled to receive such information in advance, or to any other person whomsoever.

Regulation 4.—These regulations may be amended at any time by order of the Secretary of Agriculture.

Regulation 5.—The Chief of the Bureau of Agricultural Economics shall deliver a copy of these regulations, copies of such amendments thereto as may be made from time to time, and copies of sections 123 and 124 of the act of March 4, 1909 (35 Stat. 1110), to every officer or employee of the Department of Agriculture, or person acting in any capacity under or by virtue of the authority of the Department of Agriculture, who, by virtue of the office, employment, or position held by him, may become possessed of any information concerning the acreages, conditions, yields, farm reserves, or quality, or any other information which might exert an influence upon or affect the market value of any products of the soil dealt with by the Bureau of Agricultural Economics and specified in regulation 1, and take his receipt therefor. Every such copy shall contain an accurate description of these regulations, of sections 123 and 124 of the act of March 4, 1909 (35 Stat. 1110), or of amendments to those regulations, as the case may be, and shall be recorded and filed in the office of the Chief of the Bureau of Agricultural Economics.

HENRY C. WALLACE,
Secretary of Agriculture.

EXTRACT FROM THE PENAL LAWS OF THE UNITED STATES, APPROVED MARCH 4, 1909.

“SECTION 123. Whoever, being an officer or employee of the United States or a person acting for or on behalf of the United States, in any capacity under or by virtue of the authority of any department or office thereof, and while holding such office, employment, or position shall, by virtue of the office, employment, or position held by him, become possessed of any information which might exert an influence upon or affect the market value of any product of the soil grown within the United States, which information is by law or by the rules of the department or office required to be withheld from publication until a fixed time, and shall willfully impart, directly or indirectly, such information, or any part thereof, to any person not entitled under the law or the rules of the department or office to receive the same; or shall, before such information is made public through regular official channels, directly or indirectly speculate in any such product respecting which he has thus become possessed of such information, by buying or selling the same in any quantity, shall be fined not more than \$10,000 or imprisoned not more than 10 years, or both: *Provided*, That no person shall be deemed guilty of a violation of any such rule unless prior to such alleged violation he shall have had actual knowledge thereof.

“SECTION 124. Whoever, being an officer or employee of the United States and whose duties require the compilation or report of statistics or information relative to the soil, shall knowingly compile for issuance, or issue, any false statistics or information as a report of the United States shall be fined not more than \$5,000 or imprisoned not more than five years, or both.”

I certify that I have this _____ day of _____, 1924, received two copies of the foregoing “Regulations of the Department of Agriculture Governing the Publication of Reports and the Information Utilized in the Compilation of Reports, Prepared by the Bureau of Agricultural Economics, Concerning the Acreages, Conditions, Yields, Farm Reserves, or Quality of Products of the Soil Grown within the United States,” and the above-quoted sections 123 and 124 of the act of March 4, 1909 (35 Stat. 1110). I have read and retained a copy of said regulations and law, and this copy I return signed by me as acknowledgment of receipt.

Rev. ed. follows

RY
D
4 *

UNITED STATES DEPARTMENT OF AGRICULTURE

MISCELLANEOUS CIRCULAR NO. 21

WASHINGTON, D. C.

August, 1924

POSTERS PREPARED BY SCHOOL CHILDREN IN MILK-FOR-HEALTH PROGRAMS

JESSIE M. HOOVER,

Specialist in Milk Utilization, Dairy Division, Bureau of Animal Industry



ALL THE PICTURES in this circular are made from photographs of prize-winning posters designed by school children, both city and rural. They were made by children of all grades, from the lowest grade to the last year in high school. In many cases they were made in poster contests where the pupils of one school competed with those of the same grade in other schools. These posters were made in connection with programs carried on by the communities in which the children live, with the cooperation of the State agricultural college and of the Dairy Division, Bureau of Animal Industry, United States Department of Agriculture.

The aim of an educational milk program is to encourage an intelligent use of milk, for the purpose of improving health and reducing undernourishment. In this work, which is described in Department Circular 250, "Educational Milk-for-Health Campaigns," the making of posters has been found a helpful feature; and these reproductions are published with the hope that they may be useful as suggestions to persons planning to conduct similar programs.

SUGGESTIONS TO MILK-POSTER COMMITTEES

It is very important to work out a carefully detailed plan for handling a milk-poster contest. In cities this is often managed more easily than in the county-wide contests, where a larger area must be considered. It is suggested that the committee in charge of school posters first consult with the school superintendent in order to secure his approval of the plan as well as his active cooperation in interesting the teachers.

In case there is an art supervisor her cooperation is essential; and if possible she should be chairman of the poster committee. It is

well to request the superintendent of schools to send a letter to each teacher, accompanied by poster suggestions and contest rules. The teachers' institute furnishes a good opportunity for presenting the plan for the milk program to all the teachers of a county.

It is desired, wherever possible, to have all school children, from the first grade up, enter the milk-poster contest. Competition, however, should be between children having the same attainments; that is, all the eighth grades in the county might compete with each other, the seventh grades with other seventh grades, and so on.

There may be prizes or not, as the committee wishes. One good plan is to offer first and second prizes, and several smaller prizes. The time for completion of work and the place for assembling the posters should be definitely stated. Usually three posters from each grade in a school are submitted.

The size of the poster should be specified. Many grades do poster work on 9 by 12 inch paper only. A more satisfactory size, however, is 12 by 18 inch paper.

The medium should be specified, that is, whether the posters are to be made with paint, crayon, charcoal, or pencil. The lower grades are usually allowed to use cut-outs, that is, pictures, drawings, or designs cut in silhouette from magazines, newspapers, or other posters, while the upper grades and high schools as a rule make free-hand posters. This may include free-hand paper cutting.

CONSIDERATIONS IN DESIGNING

1. The poster should attract attention by telling its story quickly and effectively. Only one story should be told in each poster. Avoid dividing interest by having a poster tell more than one story.

2. The story told by the poster must be based on facts. It must not be overstated, nor make unfair comparisons.

3. The poster must be simple and interesting, and as beautiful as possible.

4. The poster must make the reader wish to obey its message. The only lettering to be on the poster is contained in the legend. Object and letters should be drawn with the idea of being seen at as great a distance as possible.

5. *Signature:* The name, age, grade, teacher, school, and county should be written on the back of each poster. It is very important to have all these carefully given.

POINTS FOR JUDGING

Every poster should illustrate clearly and forcefully a central theme or message. Its legend should be brief and vigorous. The following points should be taken into consideration when judging posters: (1) Workmanship; (2) truth of the message; (3) originality.

The poster committee should make arrangements for having the posters judged and prizes awarded. The committee should also arrange for displaying the posters in school buildings, libraries, or other public places; store windows are commonly used for this purpose.

TOPICS FOR MILK POSTERS

The following legends have been selected from milk posters submitted by school children. They cover such points as "Milk for health," "Milk, a food for children," "Milk, a food for athletes."

- | | |
|---|--|
| Guard your health. Drink milk. (Soldier and bottle of milk.) | A quart a day keeps the children at play. |
| Get a sure grip on health. Drink milk. (Fist and bottle of milk.) | Health insurance. (Bottle of milk.) |
| Drink milk. It makes better citizens. | Milk—Economy—Health. |
| We want milk. | Use milk. |
| Long live the cow. | The milk way is the health way. |
| Athletes need milk. (Boy with football or bat.) | Flowers need water—children need milk. |
| The army of health. (Milk bottles arranged in battle formation.) | We bow before thee, O Milk, king of foods. |
| The foundation of health. (Pouring milk into glass.) | A milk drive. |
| Knock out H. C. L. (Milk bottle with arms and legs and boxing glove on hand.) | We had our milk. We did not. |
| Get wise. Use milk. | The road to health. |
| Milk makes muscle. (Athlete.) | Milk builds teeth and bone. |
| Milk makes us grow. (Child on scale with measuring rod.) | The key to health. |
| Milk for lunch. (Child with bottle of milk.) | Milk, the staff of life. |
| Drink milk and keep the farmer milking. | He will win, he drinks milk. |
| Milk—A source of energy, health, and strength. | Guard your health. |
| We're on our way to Healthland. | The foster mother of the human race. |
| | From Milkland to Healthland. |
| | She tops the world. |
| | No milk, no work. |
| | To health. (Pointing to bottle of milk.) |
| | Sail to the land of health. |
| | Milk makes kids healthy. |
| | The milk express. |



FIG. 1.—Milk posters of athletic character



FIG. 2.—Milk posters emphasizing health benefits



FIG. 3.—Posters portraying milk as children's food



FIG. 4.—A group of drink-milk posters

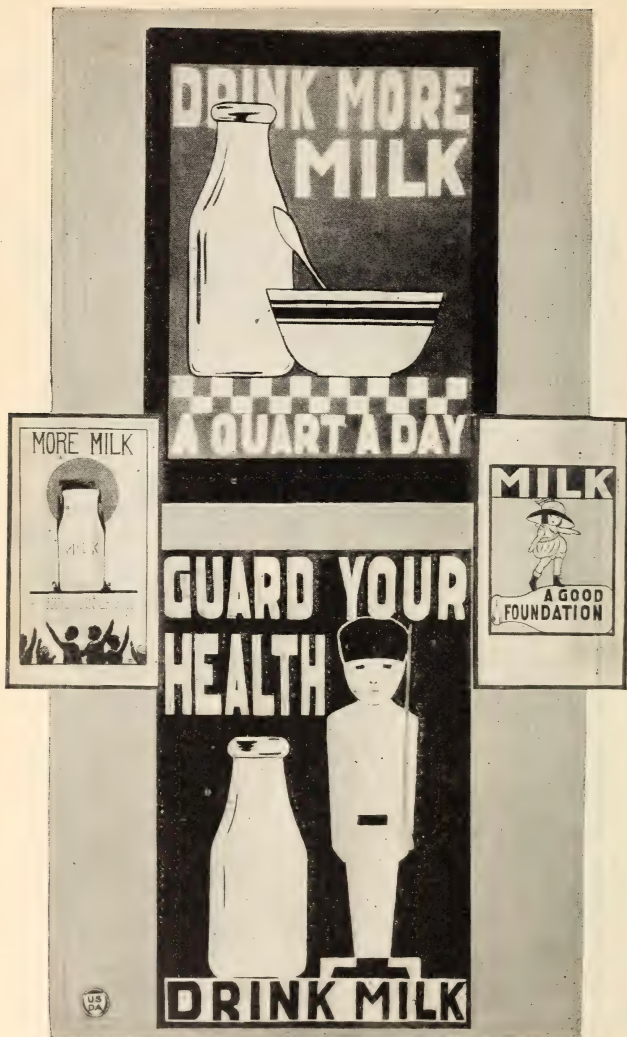

FIG. 5.—Posters designed by high-school students

6000

LIBRARY

U. S. DEPARTMENT OF AGRICULTURE

UNITED STATES DEPARTMENT OF AGRICULTURE

MISCELLANEOUS CIRCULAR NO. 21

WASHINGTON, D. C.

Issued August, 1924
Revised October, 1925

POSTERS PREPARED BY SCHOOL CHILDREN IN
MILK-FOR-HEALTH CAMPAIGNS

JESSIE M. HOOVER

Bureau of Dairying



THE ILLUSTRATIONS in this circular are of posters made in connection with milk-for-health campaigns. Most of these posters were made by children and represent the work of both city and rural boys and girls of all ages, from the lowest grade to the last year in high school. A few of the posters included were prepared by college students. In most cases these posters were made in contests in which the pupils of one school competed with those of the same grade in other schools. These poster contests were conducted in connection with milk-for-health campaigns carried on by the communities in which the children lived, with the cooperation of the State agri-

cultural college and the Bureau of Dairying, United States Department of Agriculture.

The aim of an educational milk campaign is to encourage an intelligent use of milk for the purpose of improving health and reducing undernourishment. This work is described in Department Circular 250, "Educational Milk-for-Health Campaigns." The making of milk posters has been found a helpful feature of these campaigns, and reproductions are published here with the hope that they may be useful as suggestions to persons planning to conduct similar campaigns.

SUGGESTIONS TO MILK-POSTER COMMITTEES

It is very important to work out a carefully detailed plan for handling a milk-poster contest. In cities this is often managed more easily than in the county-wide contests where a larger area, with communities more or less isolated, must be considered. It is suggested that the committee in charge of school posters first consult

with the school superintendent in order to obtain his approval of the plan, as well as his active cooperation in interesting the teachers.

The cooperation of the art supervisor is essential, and, if possible, this supervisor should be chairman of the poster committee. It is well to request the superintendent of schools to send to each teacher a letter of information, accompanied by poster suggestions and contest rules. The teachers' institute furnishes a good opportunity for presenting the plan of the milk campaign to all the teachers of a county.



FIG. 1

It is desired, wherever possible, to have all school children from the first grade up enter the milk-poster contest. Competition, however, should be between children having similar attainments; that is, all the eighth grades in the county might compete with each other, the seventh grades with other seventh grades, and so on. Some unusual conditions have been found where it

has been deemed advisable to have children of certain schools compete with others within their own groups rather than on a city or county-wide basis. An illustration of this is the foreign section of a city, where the children are devoting their energies not only to the regular curriculum but also to learning a language and unfamiliar customs. It would be obviously unfair to have them compete with those who already know the language and customs and have only the regular educational program to consider.

In each contest the size of the poster should be specified. Many schools have found that paper 14 by 22 inches or 22 by 28 inches is most satisfactory, although smaller sizes are frequently used to good advantage. The medium should be specified; that is, whether the posters are to be made with paint, crayon, charcoal, or pencil. The

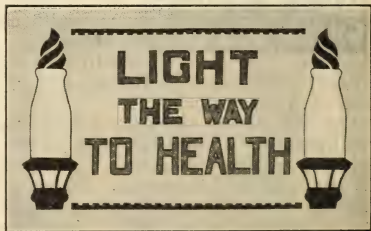

FIG. 2

lower grades are frequently allowed to use cut-outs—pictures, drawings, or designs cut from magazines, newspapers, or other posters. They also use free-hand paper cutting. The upper grades and high school as a rule make their posters free-hand, using paper cutting, charcoal, pencil, crayons, water colors, ink, or other suitable material.

The time for completion of the work and the place for assembling the posters should be definitely stated. The teachers usually select at least three of the best posters from each grade in a school and submit them to the committee.

There may be prizes or not, as the committee wishes. When prizes are offered, there is more widespread interest among the children if in addition to the first and second prizes there are several smaller prizes.

The poster committee should make arrangements for having the posters judged and prizes awarded. The committee should also arrange for displaying the posters in school buildings, libraries, or other public places. Store windows are commonly used for this purpose and they are usually available.

HOW TO MAKE A POSTER

Poster making is creative work. Its object is to convey ideas so quickly and so forcefully that they will catch the attention of the



FIG. 3



FIG. 4

reader and induce him to action. Therefore, the first essential is an idea or message. Milk-for-Health presents a good basis for a message. Milk-for-Health posters should be made attractive. It is not wise to attempt to teach health by showing the opposite of health. When health is portrayed on a poster it should be made so attractive, radiating joy and happiness, that both the maker of the poster and the reader will wish to endeavor to imitate this likeness. The teacher may wish to get the pupils to suggest how health looks when illustrated. Some of these attributes are as follows: Smooth skin, glossy hair, sparkling eyes, smiling expression, gracefulness, happiness, energy for work and play, eagerness for study, sturdy appearance.

How, then, can we illustrate Milk-for-Health? Since the children must first have an idea, the teachers as a rule find it advisable to question them and obtain from them statements regarding Milk-

for-Health. After these have been listed, it is usually a good plan to take the statements one by one and ask the children to simplify and shorten them, that they may be suitable for use as legends on the posters. Brevity and forcefulness are fundamental. At the close of this circular are legends which have been prepared and used on posters made by children in Milk-for-Health campaigns.

Having decided on a suitable idea, it is well to consider its presentation. The child can not express anything pictorially without first having a vision or a concept. His thoughts will center around his own experiences, and through these he gets his concepts and ideas. The teacher should, therefore, be sure that the children have a clear-cut idea before having them attempt to present it pictorially. Many teachers find it expedient to have the children present a rough sketch before working on their poster paper.

Both pictures and lettering may be made of flat one-toned paper, which are cut and pasted on contrasting foundation paper. This makes a very simple poster. An illustration is shown in Figure 1.

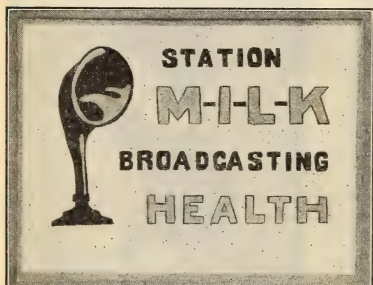

FIG. 5

tering, like the picture, should be simple in design, so that it may be quickly read.

Charcoal makes an effective medium for posters, but special care is necessary to prevent its smearing. Pen and ink sketching is frequently used. Colored crayons (fig. 4) or water-color paints (fig. 5) are well adapted to poster work.

It should be borne in mind that neither color nor design will make the desired impression unless there is a real message told in a clear-cut simple way. The picture and the printed message should say the same thing, thus giving unity of thought. Experience in a large number of contests has shown that the judges invariably select as prize winners those posters which are simple as to design, harmonious as to color, truthful and forceful as to message.

There seems to be a strong tendency among art teachers to encourage group work on posters, thus developing community consciousness. This group work is approached in different ways according to the group and the personality of the teacher. One plan is to have each child prepare a poster setting forth his ideas. When finished these sketches are displayed, their merits discussed, and the best ones chosen by the children with the aid of the teacher. These

posters are then worked upon by the entire group in order that they may represent the composite thought and skill of all.

When paper cutting is made the medium for a composite poster, the teachers frequently have all of the children cut out the object to be portrayed, such as a milk bottle, cow, child, or milk wagon. The best forms are then selected for the poster which is to represent the entire group. In a contest where prizes are given, the prize in such a case will be presented to the group rather than to an individual.

Group work of this kind is certainly of unquestioned value educationally, as it leads the children to develop their own ideas. It is of civic value in that it promotes group thought in regard to a community project.

CONSIDERATIONS IN DESIGNING

1. The poster should attract attention by telling its story quickly and effectively. Only one story should be told in each poster. Avoid dividing interest by having a poster tell more than one story.

2. The poster must make the reader wish to obey its message.

3. The story told by the poster must be based on facts. It must not be overstated or make unfair comparisons.

4. The poster must be simple and interesting and as beautiful as possible. The only lettering on the poster should be that contained in the legend, and this should be as brief as possible. Objects and letters should be drawn with the idea of being seen at a distance. Small details should be avoided.

5. It is usually more effective to use only one medium in making a poster, as cut-out paper, paint, ink, crayon, or pencil, but never all of them on the same poster. To have several mediums gives the impression of disorder rather than unity of thought and expression. When possible the lettering should be done with the same medium as the picture itself. This is not always practicable, however, because of lack of suitable materials. Rules should be sufficiently flexible to permit all children to enter the poster contest.

6. *Signature*.—The name, age, grade, teacher, school, county, and State should be written on the back of each poster. It is very important to have all these carefully given.

POINTS FOR JUDGING

Every poster should illustrate clearly and forcefully a central theme or message. Its legend should be brief and vigorous. The following points should be taken into consideration when judging posters: (1) Originality; (2) truth and forcefulness of the message; (3) workmanship.

LEGENDS FOR MILK POSTERS

The following legends have been selected from milk posters submitted by school children. They cover such points as "Milk for health," "Milk, a food for children," "Milk, a food for athletes."

- Guard your health. Drink milk. (Soldier and bottle of milk.)
 Get a sure grip on health. Drink milk. (Fist and bottle of milk.)
 Drink milk. It makes better citizens. We want milk.
 Long live the cow.
 Athletes need milk. (Boy with football or bat.)
 The army of health. (Milk bottles arranged in battle formation.)
 The foundation of health. (Pouring milk into glass.)
 Get wise. Use milk.
 Milk makes muscle. (Athlete.)
 Milk makes us grow. (Child on scale with measuring rod.)
 Milk for lunch. (Child with bottle of milk.)
 Drink milk and keep the farmer milking.
 Milk—A source of energy, health, and strength.
 We're on our way to Healthland.
 A quart a day keeps the children at play.
 Milk—Economy—Health.
 Use milk.
 The milk way is the health way.
 Flowers need water—children need milk.
 A milk drive.
 We had our milk. We did not.
 The road to health.
 Milk builds teeth and bone.
 The key to health.
 Milk, the staff of life.
 He will win, he drinks milk.
 Guard your health.
 The foster mother of the human race.
 From Milkland to Healthland.
 She tops the world.
 No milk, no work.
 To health. (Pointing to bottle of milk.)
 Sail to the land of health.
 Milk makes kids healthy.
 The milk express.
 Milk puts the I Can in the A-mer-ican.
 I'm being raised on milk. Watch me grow.
- A cargo of health.
 Stepping stones to health.
 Be ye drinkers of milk, not hearers only.
 Day by day take the milky way, and you'll grow better and better.
 Milk, the star food.
 Milk, the life saver.
 Milk wins.
 Milk is a winner for every dinner.
 Fresh milk for the rising son.
 The health dance.
 Health for your city. Drink milk.
 The way to health.
 I'm your friend. Drink more milk. (Cow.)
 Backed by the best. (Bottle of milk. Flag.)
 Milk makes muscle.
 Just from the milky way.
 Fountain of youth.
 Health in every drop.
 You can tell I drink milk.
 Milk is health insurance.
 Why a cat has nine lives.
 A nation's power.
 The power behind the bat.
 Station M-I-L-K broadcasting health.
 Health deliverer.
 Here's to health.
 Milk, beacon light to health.
 It's built on milk. (World.)
 Try milk, master of health.
 Milk for health.
 Delivering health.
 From sun up to sun down, your best friend.
 Milk is the Hercules of the world.
 The pied piper of health. (Milk bottle as piper.)
 Gas for cars. Milk for kids.
 Station C-O-W broadcasting health.
 Wise scouts drink milk.
 Milk the keynote of health.
 Milk, a high-power food.
 Drink milk and live long.
 Milk, make it the national drink.
 Milk is hand in hand with health.
 A good investment in health.
 More milk. Better lessons.

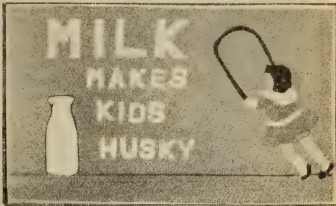



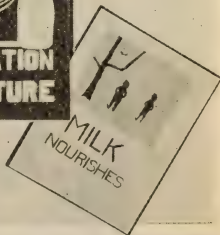
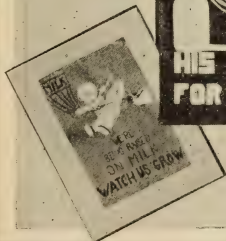
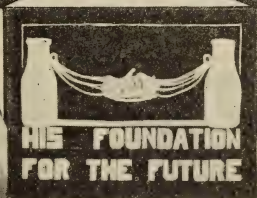
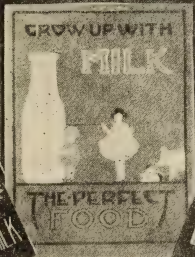
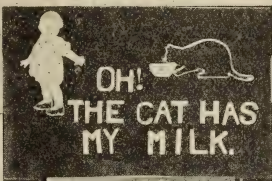

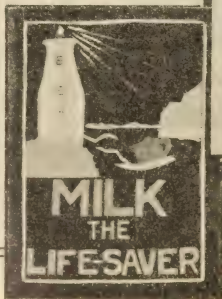
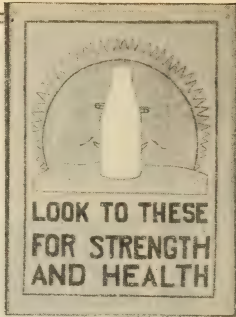

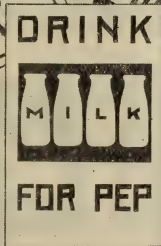
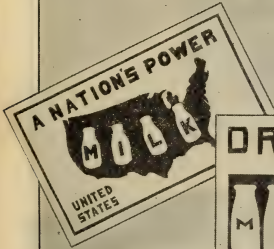

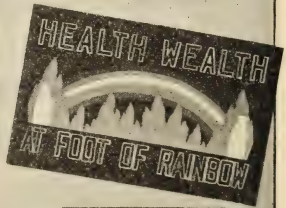
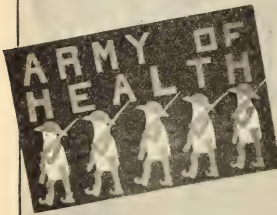
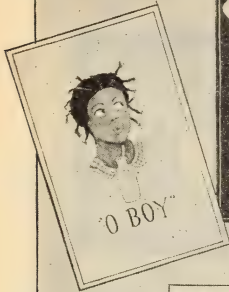

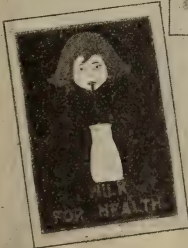
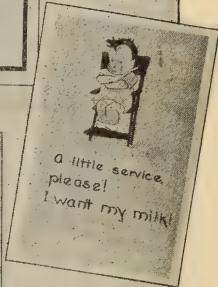
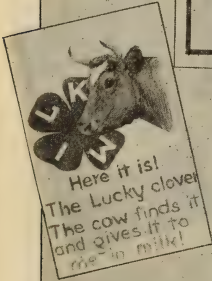



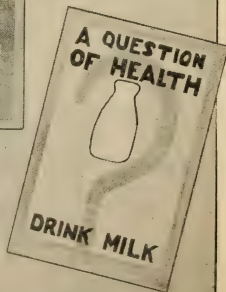
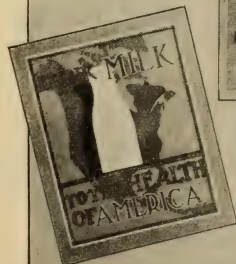
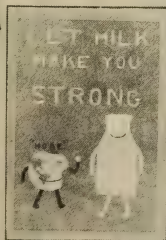
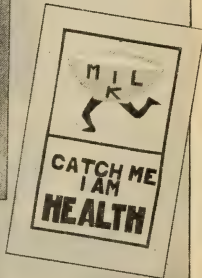



86
30

UNITED STATES DEPARTMENT OF AGRICULTURE

MISCELLANEOUS CIRCULAR NO. 22

WASHINGTON, D. C.

Supplements
follow

MARCH, 1924

**THE NAVAL STORES ACT AND REGULATIONS FOR
ITS ENFORCEMENT.**

INTRODUCTION.

The act entitled "An act establishing standard grades of naval stores, preventing deception in transactions in naval stores, regulating traffic therein, and for other purposes" was approved March 3, 1923.

The accompanying regulations for its enforcement, effective March 1, 1924, are published for the information and guidance of those concerned.

HENRY C. WALLACE,
Secretary of Agriculture.

WASHINGTON, D. C., *February 11, 1924.*

**AN ACT ESTABLISHING STANDARD GRADES OF NAVAL STORES,
PREVENTING DECEPTION IN TRANSACTIONS IN NAVAL STORES,
REGULATING TRAFFIC THEREIN, AND FOR OTHER PURPOSES.**

Be it enacted by the Senate and House of Representatives of the United States of America in Congress assembled, That, for convenience of reference, this act may be designated and cited as "The Naval Stores Act."

SEC. 2. That, when used in this act—

- (a) "Naval stores" means spirits of turpentine and rosin.
- (b) "Spirits of turpentine" includes gum spirits of turpentine and wood turpentine.
- (c) "Gum spirits of turpentine" means spirits of turpentine made from gum (oleoresin) from a living tree.
- (d) "Wood turpentine" includes steam distilled wood turpentine and destructively distilled wood turpentine.
- (e) "Steam distilled wood turpentine" means wood turpentine distilled with steam from the oleoresin within or extracted from the wood.
- (f) "Destructively distilled wood turpentine" means wood turpentine obtained in the destructive distillation of the wood.
- (g) "Rosin" includes gum rosin and wood rosin.
- (h) "Gum rosin" means rosin remaining after the distillation of gum spirits of turpentine.
- (i) "Wood rosin" means rosin remaining after the distillation of steam distilled wood turpentine.
- (j) "Package" means any container of naval stores, and includes barrel, tank, tank car, or other receptacle.
- (k) "Person" includes partnerships, associations, and corporations, as well as individuals.
- (l) The term "commerce" means commerce between any State, Territory, or possession, or the District of Columbia, and any place outside thereof; or between points within the same State, Territory, or possession, or the District

of Columbia, but through any place outside thereof; or within any Territory or possession or the District of Columbia.

SEC. 3. That for the purposes of this act the kinds of spirits of turpentine defined in subdivisions (c), (e), and (f) of section 2 hereof and the rosin types heretofore prepared and recommended under existing laws, by or under authority of the Secretary of Agriculture, are hereby made the standards for naval stores until otherwise prescribed as hereinafter provided. The Secretary of Agriculture is authorized to establish and promulgate standards for naval stores for which no standards are herein provided, after at least three months' notice of the proposed standard shall have been given to the trade, so far as practicable, and due hearings or reasonable opportunities to be heard shall have been afforded those favoring or opposing the same. No such standard shall become effective until after three months from the date of the promulgation thereof. Any standard made by this act or established and promulgated by the Secretary of Agriculture in accordance therewith may be modified by said secretary whenever, for reasons and causes deemed by him sufficient, the interests of the trade shall so require, after at least six months' notice of the proposed modifications shall have been given to the trade, so far as practicable, and due hearings or reasonable opportunities to be heard shall have been afforded those favoring or opposing the same; and no such modification so made shall become effective until after six months from the date when made.

The various grades of rosin, from highest to lowest, shall be designated, unless and until changed, as hereinbefore provided, by the following letters, respectively, X, WW, WG, N, M, K, I, H, G, F, E, D, and B, together with the designation "gum rosin" or "wood rosin," as the case may be.

The standards herein made and authorized to be made shall be known as the "Official Naval Stores Standards of the United States," and may be referred to by the abbreviated expression "United States Standards," and shall be the standards by which all naval stores in commerce shall be graded and described.

SEC. 4. That the Secretary of Agriculture shall provide, if practicable, any interested person with duplicates of the official naval stores standards of the United States upon request accompanied by tender of satisfactory security for the return thereof, under such regulations as he may prescribe. The Secretary of Agriculture shall examine, if practicable, upon request of any interested person, any naval stores and shall analyze, classify, or grade the same on tender of the cost thereof as required by him, under such regulations as he may prescribe. He shall furnish a certificate showing the analysis, classification, or grade of such naval stores, which certificate shall be prima facie evidence of the analysis, classification, or grade of such naval stores and of the contents of any package from which the same may have been taken, as well as of the correctness of such analysis, classification, or grade and shall be admissible as such in any court.

SEC. 5. That the following acts are hereby declared injurious to commerce in naval stores and are hereby prohibited and made unlawful:

(a) The sale in commerce of any naval stores, or of anything offered as such, except under or by reference to United States standards.

(b) The sale of any naval stores under or by reference to United States standards which is other than what it is represented to be.

(c) The use in commerce of the word "turpentine" or the word "rosin," singly or with any other word or words, or of any compound, derivative, or imitation of either such word, or of any misleading word, or of any word, combination of words, letter or combination of letters, provided herein or by the Secretary of Agriculture to be used to designate naval stores of any kind or grade, in selling, offering for sale, advertising, or shipping anything other than naval stores of the United States standards.

(d) The use in commerce of any false, misleading, or deceitful means or practice in the sale of naval stores or of anything offered as such.

SEC. 6. That any person willfully violating any provision of section 5 of this act shall, on conviction, be punished for each offense by a fine not exceeding \$5,000 or by imprisonment for not exceeding one year, or both.

SEC. 7. That the Secretary of Agriculture is hereby authorized to purchase from time to time in open market samples of spirits of turpentine and of anything offered for sale as such for the purpose of analysis, classification, or grading and of detecting any violation of this act. He shall report to the Department of Justice for appropriate action any violation of this act coming to his knowledge. He is also authorized to publish from time to time results

of any analysis, classification, or grading of spirits of turpentine and of anything offered for sale as such made by him under any provision of this act.

SEC. 8. That there are hereby authorized to be appropriated, out of any moneys in the Treasury not otherwise appropriated, such sums as may be necessary for the administration and enforcement of this act, and within the limits of such sums the Secretary of Agriculture is authorized to employ such persons and means and make such expenditures for printing, telegrams, telephones, books of reference, periodicals, furniture, stationery, office equipment, travel and supplies, and all other expenses as shall be necessary in the District of Columbia and elsewhere.

SEC. 9. That, if any provision of this act or the application thereof to any person or circumstances is held invalid, the validity of the remainder of the act and of the application of such provision to other persons and circumstances shall not be affected thereby.

SEC. 10. That this act shall become effective at the expiration of ninety days next after the date of its approval.

Approved, March 3, 1923.

REGULATIONS FOR THE ENFORCEMENT OF THE NAVAL STORES ACT.

Regulation 1.—Short Title of the Act.

(Section 1.)

The "act establishing standard grades of naval stores, preventing deception in transactions in naval stores, regulating traffic therein, and for other purposes," approved March 3, 1923, may be designated and cited as the naval stores act.

Regulation 2.—Scope of the Act.

The provisions of the act apply to all sales of spirits of turpentine and rosin or anything offered as such in interstate or foreign commerce or in the District of Columbia, Territories, and possessions of the United States. The act forbids all sales of spirits of turpentine and rosin in intrastate commerce under or by reference to United States standards which is other than what it is represented to be.

Regulation 3.—Definition of Terms Used in the Regulations.

- (a) *Secretary*.—Secretary of Agriculture of the United States.
- (b) *Bureau*.—Bureau of Chemistry of the United States Department of Agriculture.
- (c) *Chief of bureau*.—Chief of the Bureau of Chemistry of the United States Department of Agriculture.
- (d) *Naval stores*.—Spirits of turpentine and rosin, as defined in the act.
- (e) *Standards*.—Official naval stores standards of the United States.
- (f) *Analysis*.—Macroscopical, microscopical, or chemical examination.
- (g) *Classification*.—Kind of spirits of turpentine or rosin.
- (h) *Grade*.—Designation of rosin by reference to the standards.
- (i) *Person*.—Partnerships, associations, and corporations, as well as individuals.
- (j) *Inspector*.—Any person appointed a United States naval stores inspector by the Secretary of Agriculture to examine, classify, and grade naval stores.
- (k) *Analyst*.—Any person in the employ of the bureau who is designated by the chief of bureau to analyze naval stores.
- (l) *Package*.—Any container of naval stores; it includes barrel, tank car, or other receptacle.

Regulation 4.—Administration.

(Section 8.)

- (a) Inspectors may be assigned to such places as may be necessary for the proper enforcement of the act.
- (b) Inspectors will sample and grade rosin upon request as hereinafter provided and collect samples of turpentine or rosin.
- (c) Inspectors shall be responsible for the proper performance of the duties imposed upon them.

Regulation 5.—Establishing New or Modified Standards.

(Section 3.)

Whenever in the opinion of the secretary a standard is necessary for naval stores for which no standard is provided, or whenever for reasons deemed by him sufficient the interests of the trade require a modification of an existing standard, opportunities to be heard will be given those favoring or opposing the proposed standard or proposed modification of a standard. When the hearing is to be called for consideration of new standards, three months' notice in advance of the hearing will be given; when the hearing is to be called for consideration of the modification of an existing standard, six months' notice in advance of the hearing will be given. When a standard is established for naval stores for which no standard is provided, such standard shall become effective after three months from the date of the promulgation thereof; when an existing standard is modified, such modification shall become effective after six months from the date of the promulgation thereof.

Regulation 6.—Standards for Spirits of Turpentine.

(Section 3.)

Until other standards for spirits of turpentine are established by the secretary, the following standards are in effect:

- (a) *Gum spirits of turpentine*, the spirits of turpentine made from gum (oleoresin) from a living tree.
- (b) *Steam distilled wood turpentine*, wood turpentine distilled with steam from the oleoresin within or extracted from the wood.
- (c) *Destructively distilled wood turpentine*, wood turpentine obtained in the destructive distillation of the wood.

Regulation 7.—Standards for Grading and Classification of Rosin.

(Section 3.)

Unless and until other standards for rosin are established by the secretary, the standards for rosin are the rosin types prepared and recommended by the secretary prior to March 3, 1923, and the various grades of such standards, from highest to lowest, shall be designated, unless and until changed, by the following letters, respectively, X, WW, WG, N, M, K, I, H, G, F, E, D, and B, together with the designation "gum rosin" or "wood rosin," as the case may be.

Regulation 8.—Samples.

(Section 4.)

Any naval stores shall be analyzed, classified, and graded, if practicable, upon the request of any interested person.
Samples shall be taken by an inspector.

(Sections 5 and 7.)

For the purpose of determining whether section 5 of the act has been violated, samples shall be collected by an inspector.

Regulation 9.—Directions for Taking Sample.

(Sections 4, 5, and 7.)

Samples of turpentine and rosin within the scope of the act shall be representative.

All samples shall become and remain the property of the United States Department of Agriculture and be disposed of as it may determine.

Regulation 10.—Requests for Analysis, Classification, and Grading.

(Section 4.)

(a) A request to analyze, classify, or grade naval stores shall be made to the bureau or to the nearest inspector, in writing (Reg. 3 (j)).

(b) A request to analyze, classify, or grade naval stores shall state the number and kinds of packages of rosin or the number and kinds of packages and number of gallons of turpentine, the name of the interested person, for whose account the examination is requested, and his interest in the naval stores. It shall be signed by such interested person or in his behalf by his agent.

(c) A request to analyze, classify, or grade naval stores may be withdrawn in writing by the applicant at any time before the analysis, classification, or grading has been completed, subject to the payment of such fees and expenses, if any, as may be prescribed pursuant to Regulation 14.

(d) Naval stores, except spirits of turpentine in tank cars, of which analysis, classification, or grade has been requested shall remain intact and undisturbed until the analysis, classification, or grading has been completed and the packages marked in accordance with the provisions of Regulation 16, unless such request shall have been withdrawn.

(e) Tank cars containing spirits of turpentine of which analysis, classification, or grade has been requested, after the sample of the spirits of turpentine has been taken by an inspector, shall be sealed by him with a seal prescribed by the department. Such cars, so sealed, may be moved prior to the completion of the analysis, classification, or grading. However, the analysis, classification, or grade as shown by the certificate shall apply to the contents of the tank car only while the seal on said tank car remains intact.

Regulation 11.—Certificate.

(Section 4.)

(a) A certificate for each lot of naval stores analyzed, classified, or graded under the act shall be issued to the interested person.

(b) The certificate shall contain the information required by the act and shall be numbered.

Regulation 12.—Methods of Analysis.

(Sections 4, 5, 6, and 7.)

(a) The methods of chemical analysis shall be those prescribed by the Association of Official Agricultural Chemists, when applicable, provided, however, that any method of analysis or examination satisfactory to the bureau may be employed.

(b) If no method of chemical analysis has been prescribed by the Association of Official Agricultural Chemists, any method of analysis or examination methods satisfactory to the bureau may be employed.

Regulation 13.—Rosin Grading.

(Section 4.)

An interested person making the request for the analysis, classification, or grade shall, at his own expense, cause the rosin to be made available to the inspector, shall remove the heads, spike the rosin under the supervision of the United States inspector, recoper the barrel, and prepare the barrel for marking by the inspector.

Regulation 14.—Cost of Analysis, Classification, and Grading.

(Section 4.)

(a) For the analysis, classification, or grading of each sample of turpentine pursuant to these regulations, the person requesting the analysis shall pay a fee of \$2 and in addition a fee of 4 cents per package for marking.

(b) For the classification and grading of each lot of rosin pursuant to these regulations the person requesting the classification or grading shall pay a fee

of 10 cents per package for classification, grading, and marking the package, provided, however, the minimum charge for classification and grading any lot of rosin shall be \$1.

(c) The fee for the analysis of a sample of rosin shall be fixed by the chief of bureau in each instance.

(d) No fee shall be charged for a new certificate issued in lieu of an outstanding certificate solely for the purpose of correcting clerical errors therein or for the purpose of substituting a new form for an outstanding certificate.

(e) When the request for the analysis, classification, or grade of a lot of naval stores shall be withdrawn, such proportional part of the fees fixed in (a), (b), or (c) of this regulation shall be charged according to the work done or preparation made.

(f) When any work in connection with the analysis, classification, or grading of naval stores shall be performed at a place other than where an inspector is regularly located, the interested person making the request for such analysis, classification, or grading, in addition to the fees hereinbefore prescribed, will be requested to reimburse the United States in accordance with the fiscal regulations of the United States Department of Agriculture for the necessary traveling expenses and subsistence or per diem in lieu of subsistence incurred by the inspector.

(g) Any shipping expenses in connection with any sample taken at the request of an interested person shall be borne by such person.

(h) The chief of bureau shall deliver bills to all persons from whom payment for fees or expenses on account of services rendered shall be due. Such bills shall be rendered as soon as practicable after the last day of each month. When necessary, in the discretion of the chief of bureau, any such bill may be rendered at an earlier date. Payment of such bill shall be made within 15 days after the date rendered by check, draft, or post office or express money order, payable to the order of "Disbursing Clerk, U. S. Department of Agriculture," and mailed to "Chief, Bureau of Chemistry, U. S. Department of Agriculture, Washington, D. C."

(i) The chief of bureau may require from any interested person requesting the analysis, classification, or grading of any lot of naval stores a deposit sufficient to cover the fees and expenses involved in such analysis, classification, or grading.

(j) Any deposit under this regulation shall be by certified check, draft, or post office or express money order only, payable to the order of "Disbursing Clerk, U. S. Department of Agriculture," and mailed to "Chief, Bureau of Chemistry, U. S. Department of Agriculture, Washington, D. C."

(k) All moneys received under (a), (b), (c), (e), or (f) of this regulation will be covered into the United States Treasury as miscellaneous receipts. Money deposited under (i) hereof will be carried in the special deposit account until the exact amount to be charged is ascertained, when as much as is due the Government will be covered into the United States Treasury as miscellaneous receipts and the balance returned to the party transmitting it.

Regulation 15.—Labels.

(Section 8.)

(a) Naval stores under this act are not required to be marked, branded, or labeled except as set forth in this regulation.

(b) The word "turpentine" or the word "rosin," singly or with any other word or words, or any compound, derivative, or imitation of either of these words, or any misleading word, or any word, combination of words, letters, or combination of letters, provided by the act and by these regulations, shall not be used in commerce, in selling, offering for sale, advertising, or shipping anything that is not naval stores of the United States standards.

(c) Spirits of turpentine in commerce shall be designated or described as "gum spirits of turpentine," "steam distilled wood turpentine," or "destructively distilled wood turpentine," as the case may be.

(d) If spirits of turpentine are described on the package, the terms "gum spirits of turpentine," "steam distilled wood turpentine," or "destructively distilled wood turpentine," as the case may be, must be used.

(e) Rosin in commerce shall be designated and described by the letter or letters signifying its standard, together with the classification "gum rosin" or "wood rosin," as the case may be.

(f) If rosin is described on the package, it must be described by the letter or letters signifying its standard, together with the classification "gum rosin" or "wood rosin," as the case may be.

Regulation 16.—Labeling United States Examined Turpentine and Rosin.

(Section 4.)

(a) Except in the case of tank cars, the inspector shall mark upon each package of a lot of turpentine examined by him, at the request of an interested person, and found to be of United States standard, the fact that it has been United States examined, together with the classification, the grade, the number of the certificate, and such further marks as the chief of bureau shall require. If, however, the article examined does not comply with any of the United States standards, the packages containing it shall not be marked by the inspector.

(b) The inspector shall mark upon each package of a lot of rosin examined by him, at the request of an interested person, the fact that it has been United States examined, together with the classification, the grade, the number of the certificate, and such further marks as the chief of bureau shall require. If the article in the package is not rosin, the package shall not be marked by the inspector.

Regulation 17.—Loan and Care of Duplicates of United States Standards.

(Section 4.)

(a) Duplicates of the United States standards shall not be sold. Upon request they will be furnished, so far as the supply in the possession of the department will permit, to State inspectors of naval stores, chambers of commerce, boards of trade, and to such trade organizations as in the opinion of the chief of bureau require them, and loaned to any interested person. They may be recalled at any time by the chief of bureau.

(b) Interested persons requesting loans of duplicates of United States standards shall forward to "Chief, Bureau of Chemistry, U. S. Department of Agriculture, Washington, D. C., a certified check or post office or express money order, in the sum of two hundred dollars, payable to "The Disbursing Clerk, U. S. Department of Agriculture." This money shall be held by said disbursing clerk as security for the safe return of said duplicates and shall be deposited in his special deposit account.

(c) The interested person requesting the loan of such duplicates shall authorize the disbursing clerk of the United States Department of Agriculture to reimburse the United States out of such money for the cost of replacement of said duplicates if for any reason they can not be returned, or to replace any missing part thereof, or to repair any damage to the duplicates, prior to their return and receipt by the bureau. The form of request for the loan of the duplicate of the United States standards and of the authorization for the disbursing clerk to use such money as specified in this regulation shall be the form furnished by the chief of bureau upon application.

(d) The money held as such security, less such amount as may be necessary to replace any missing parts of or to repair any damage to the duplicates, will be returned after the receipt of such duplicates by the bureau.

(e) Where the duplicates are damaged in any way or any parts thereof are missing, the full set of duplicates shall be returned to the bureau. When the repairs are made or the missing parts supplied, the full set will be returned to the party to whom it had been furnished or loaned, on the payment by him of the cost of repairs or of the missing parts.

(f) All money received for payment of missing parts or for repairs shall be paid in to the United States Treasury as miscellaneous receipts.

Regulation 18.—Publication.

(Section 7.)

(a) After judgment of the court in any proceeding under the act, notice shall be given by publication. Such notice shall include the finding of the court and may include the analysis, classification, and grade, and such explanatory statements of fact as may be appropriate. If an appeal shall

have been taken from the judgment of the court before such publication, that fact shall appear.

(b) The results of the analysis, classification, or grading made under this act of any spirits of turpentine or anything offered as such may be published from time to time.

(c) Publications under this regulation may be in the form of a circular notice or bulletin.

Regulation 19.—Hearings.

(Section 7.)

(a) Whenever it appears that any naval stores are in violation of section 5 of the act, notice may be given to the person from whom the sample was collected and to such other person or persons as may be advisable, and a date shall be fixed at which such person or persons shall be heard. This hearing shall be held at the office of the inspector most convenient to the persons cited, or at the bureau, and shall be private and confined to matters of fact. The person or persons notified may present evidence, either oral or written, in person or by attorney, to show cause why the matter should not be referred for prosecution as a violation of the naval stores act.

(b) After a hearing is held, if it appears that the act has been violated, the secretary may report the facts for prosecution.

(c) An official of any State, Territory, city, or possession of the United States, or the District of Columbia, or his agent, individually commissioned by the secretary to collect samples, who obtains satisfactory evidence of any violation of section 5 of the act, shall submit such evidence to the bureau in order that a date for a hearing may be fixed and notice given to the proper person or persons.

INDEX.

	Regulation.	Section.
Administration of act.....	4	8
Analysis:		
cost of.....	14	4
methods of.....	12	4
request for.....	8, 10	4
Appropriations for enforcement of act.....		8
Certificate of analysis, classification, or grading.....	11	4
Classification:		
cost of.....	14	4
request for.....	8, 10	4
Cost of analysis, classification, and grading.....	14	4
Court decisions.....	18	7
Date act is effective.....		10
Definition of terms.....	3	2
Duplicate standards.....	17	4
Grading:		
cost of.....	14	4
methods of.....	7, 8, 13	3, 4
request for.....	10	4
Hearings.....	5, 19	7
Inspectors' duties.....	4	
Labeling naval stores.....	15, 16	4, 5, 8
Penalties for violation of act.....		6
Publication of court decisions.....	18	7
Purchase of samples.....		7
Sale of naval stores.....		5
Sampling naval stores.....	4, 8, 9	4, 5, 7
Scope of act.....	2	
Short title.....	1	1
Standards:		
duplicate.....	17	4
rosin.....	5, 7	3
spirits of turpentine.....	5, 6	3
Validity of act.....		9
Violation of act.....	8	6

36 Cm

LIBRARY RECEIVED

★ NOV 4 1925

UNITED STATES DEPARTMENT OF AGRICULTURE

MISCELLANEOUS CIRCULAR No. 22

SUPPLEMENT No. 1

Washington, D. C.



August 12, 1925

**AMENDMENT TO REGULATIONS FOR THE ENFORCEMENT OF
THE NAVAL STORES ACT**

Regulation 15 of the regulations for the enforcement of the naval stores act is hereby amended, effective August 15, 1925, by the addition of a new paragraph (*g*) to read as follows:

(*g*) A compound containing spirits of turpentine or rosin, or both, when sold for medicinal purposes is not deemed to be subject to the provisions of the naval stores act but is subject to the provisions of the Federal food and drugs act.

W. M. JARDINE,
Secretary of Agriculture.

WASHINGTON, D. C., *August 3, 1925.*

56456—25

